

# **S-COM 7330**

## **Three Port Repeater Controller**

**7330 Controller Firmware Version 3.7.x**

**7330 SBOOT Firmware Version 1.7.x**

**7330 Package Release 1.8**

**(30 January 2019)**

**S-COM, LLC**

**P.O. Box 1546**

**LaPorte, CO 80535-1546**

**970-416-6505**

**[www.scomcontrollers.com](http://www.scomcontrollers.com)**

**[support@scomcontrollers.com](mailto:support@scomcontrollers.com)**

*This manual Copyright © 2007-2019 by S-COM, LLC. All Rights Reserved.*

Except where otherwise noted, no part of this manual may be duplicated in any form, whether electronic, mechanical, or otherwise.

*Published in the United States of America by:*

S-COM, LLC  
P.O. Box 1546  
LaPorte, CO 80535-1546  
USA

# Limited Warranty

This warranty gives you specific legal rights, and you may also have other rights which vary from state to state.

## Coverage

Except as specified below, this warranty covers all defects in material and workmanship in this product.

The following are *not* covered by the warranty:

- ~ Damage to, or deterioration of, the external cabinet.
- ~ Damage resulting from lightning, accident, misuse, abuse, or neglect.
- ~ Damage resulting from failure to follow instructions contained in the owner's manual.
- ~ Damage occurring during shipment of the product (claims must be presented to the carrier).
- ~ Damage resulting from repair or attempted repair by anyone other than S-COM, LLC.
- ~ Damage resulting from causes other than product defects, including lack of technical skill, competence, or experience of the user.
- ~ Damage to any unit which has been altered or on which the serial number has been defaced, modified, or removed.

## Enforcement

This warranty may be enforced only by the original purchaser. The warranty is not transferrable.

## Length Of Warranty

For both labor and parts, this warranty will be effective for one (1) year from the date of original purchase.

## What We Will Pay For

We will pay all labor and material expenses for items covered by the warranty. Payment of shipping charges is discussed in the next section of the warranty.

## How You Can Get Warranty Service

Your unit must be serviced by S-COM, LLC's Service Department. *Please do not return your unit to the factory without prior authorization.* You must pay any shipping charges if it is necessary to ship the product to service. However, if the necessary repairs are covered by the warranty, we will pay the return shipping charges to any destination within the U.S. Whenever warranty service is required, you must present the original dated invoice or a photocopy.

S-COM, LLC's liability for any defective products is limited to repair or replacement of the product, at S-COM, LLC's option.

S-COM, LLC reserves the right to make any changes in design or additions to, or improvements in, its products without any obligation to install such additions or improvements in equipment previously sold. S-COM, LLC further reserves the right to replace defective parts under warranty with different or improved parts.

This warranty is expressly in lieu of all other warranties, expressed or implied, including any implied warranty of merchantability or fitness, and of all other obligations or liabilities on the part of S-COM, LLC.

**Notes:**

# Table of Contents

<b>Tables</b> .....	<b>xiv</b>
<b>Product Description</b> .....	<b>1-1</b>
Standard Hardware Features .....	1-1
Configuration .....	1-1
Cabinet .....	1-2
Main Board .....	1-2
Standard Software Features .....	1-2
Identifier .....	1-2
Messages and Paging Formats .....	1-2
Timers .....	1-2
Repeater Characteristics .....	1-2
Clock and Calendar .....	1-3
Scheduler .....	1-3
Logic Inputs and Outputs / Digital Inputs and Outputs .....	1-3
A-to-D Inputs .....	1-3
Command Language .....	1-3
<b>Getting Started</b> .....	<b>2-1</b>
Testing On The Bench .....	2-2
Front Panel .....	2-4
Radio Port .....	2-4
Logic Input .....	2-5
Logic Output .....	2-6
Supply Power .....	2-6
SBOOT Mode .....	2-6
Security and Power Savings .....	2-6
Power ON Initialization .....	2-7
Initialize Controller .....	2-7
Cold Start .....	2-8
Warm Start .....	2-8
Default Condition .....	2-8
Quick-Start Setup .....	2-9
Set the Master Password .....	2-9
Set the Identifier Message .....	2-9
Set the Identifier Interval .....	2-9
Set the Path (Receiver) Access Mode .....	2-10
Set the DTMF Access Mode .....	2-11
Set the Transmitter Dropout Delay (Tail Time) .....	2-11
Set the Clock and Calendar .....	2-11
Try It Out! .....	2-12
Where Do You Go From Here? .....	2-12
<b>Programming Fundamentals</b> .....	<b>3-1</b>
Port Control .....	3-1
Paths .....	3-2
Programming .....	3-3
Control Command Structure .....	3-4
Example Control Command .....	3-5
Command Response Messages .....	3-6

Acknowledgment .....	3-6
Special Keys.....	3-7
Enter (*).....	3-7
Clear (#) .....	3-7
Valid DTMF Timing.....	3-7
DTMF Interdigit Timer.....	3-8
DTMF Mute Delay.....	3-8
Switches .....	3-9
Booleans.....	3-11
Counters.....	3-13
Timers .....	3-15
Event-Triggered Macros.....	3-18
<i>Command: Readback</i> .....	3-20

## **Security ..... 4-1**

<i>Command: Assign Master Password</i> .....	4-2
<i>Command: Assign Control Operator Password</i> .....	4-3
<i>Command: Assign Control Operator Privilege Level</i> .....	4-4
<i>Command: Assign Control Operator Privilege Level to a Range of Commands</i> .....	4-5
<i>Command: Enable/Disable Front Panel Display</i> .....	4-6

## **Macros ..... 5-1**

Quantity of Macros.....	5-1
Size of Macros.....	5-2
Names of Macros.....	5-2
Contents of Macros.....	5-3
Sequence of Execution Within A Macro.....	5-3
Changing The Sequence: If/Then/Else.....	5-4
Passwords In Macros .....	5-5
Cautions .....	5-5
Macro Loops.....	5-5
Macro Name and Password Conflicts .....	5-5
Macro Execution: DTMF Entry .....	5-6
Macro Execution: Serial Port.....	5-6
Macro Execution: Event-Triggered Macros .....	5-7
Applications of Macros.....	5-7
<i>Command: Enable/Disable Macro-Only Password Decoding</i> .....	5-8
<i>Command: Create New Macro</i> .....	5-9
<i>Command: Append To Macro</i> .....	5-11
<i>Command: Remove Last Command From Macro</i> .....	5-13
<i>Command: List Macro in CW or Speech</i> .....	5-14
<i>Command: Erase Macro</i> .....	5-16
<i>Command: Enable/Disable Erase Macro Command Returns OK</i> .....	5-17
<i>Command: Erase All Macros</i> .....	5-18
<i>Command: Rename Macro</i> .....	5-19
<i>Command: If/Then/Else</i> .....	5-21
<i>Command: Set/Clear User Software Switch</i> .....	5-24
<i>Command: Pause/Cancel Pause</i> .....	5-28
<i>Command: Select Power ON-Triggered Macro</i> .....	5-29
Long Names .....	5-31
<i>Command: Select and Control Long Names</i> .....	5-32
Backup Battery Monitoring .....	5-34
<i>Command: Assign Battery Warning-Triggered Macro</i> .....	5-35

Miscellaneous .....	5-36
<i>Command</i> : Controller Warm Start .....	5-36
<i>Command</i> : Controller Power Cycle .....	5-36
<b>Messages .....</b>	<b>6-1</b>
Control Characters .....	6-2
<i>Table</i> : Message Control Characters .....	6-3
Message Routing Control Characters .....	6-4
Route To A Single Port .....	6-4
Route To Two Ports .....	6-5
Route To Three Ports .....	6-5
Audio Mixing Control Characters .....	6-6
Mixed Audio .....	6-6
Non-Mixed Audio .....	6-6
Defaults .....	6-6
Pause Control Characters .....	6-7
Control Character .....	6-7
Format .....	6-7
Defaults .....	6-7
Synchronizing Messages and Commands .....	6-7
Interruptable Messages .....	6-9
Primary Message .....	6-9
Secondary Message .....	6-9
Message Levels .....	6-10
Message Level Values .....	6-10
<i>Table</i> : Message Levels .....	6-10
<i>Command</i> : Set Default Message Level .....	6-11
CW Messages .....	6-13
Control Character .....	6-13
Format .....	6-13
Primary/Secondary (Interruptable) CW Messages .....	6-13
Pre-Message Delays .....	6-14
Message Level .....	6-14
Wordspace Character .....	6-14
Frequency Change .....	6-15
Speed Change .....	6-15
CW Characters .....	6-16
CW Frequency Change and Speed Change Characters .....	6-17
<i>Command</i> : Select Frequency of CW .....	6-18
<i>Command</i> : Select CW Speed .....	6-19
Single-Tone Beep Messages .....	6-20
Control Character .....	6-21
Format .....	6-21
Primary/Secondary (Interruptable) Single-Tone Beep Messages .....	6-21
Single-Tone Beep Parameters (General) .....	6-22
Pre-Message Delays .....	6-22
Message Level .....	6-22
Factory-Fixed-Frequency Single-Tone Beeps .....	6-23
Owner-Fixed Frequency Single-Tone Beeps .....	6-24
Custom Single-Tone Beeps .....	6-24
Custom Single-Tone Beep Delay .....	6-25
Single-Tone Beep Gap Change Characters .....	6-25
Single-Tone Beep Duration Change Characters .....	6-26

Automatic Single-Tone Beep Gap ON Character .....	6-26
Automatic Single-Tone Beep Gap OFF Character .....	6-26
Defaults .....	6-27
<i>Command</i> : Select Frequency of Owner-Fixed Frequency Single-Tone Beeps .....	6-28
<i>Command</i> : Select Default Single-Tone Beep and Gap Durations.....	6-29
<i>Command</i> : Enable/Disable Single-Tone Beep Gap.....	6-30
Dual-Tone Beep Messages .....	6-31
Control Character .....	6-31
Format.....	6-31
Primary/Secondary (Interruptable) Dual-Tone Beep Messages .....	6-31
Pre-Message Delays.....	6-32
Message Level .....	6-32
Dual-Tone Beep Parameters .....	6-33
Factory Fixed-Frequency Dual-Tone Beeps.....	6-33
Custom Dual-Tone Beeps.....	6-34
Custom Dual-Tone Beep Delay.....	6-34
Dual-Tone Beep Gap Change Characters.....	6-35
Dual-Tone Beep Duration Change Characters .....	6-36
Automatic Dual-Tone Beep Gap ON Character.....	6-36
Automatic Dual-Tone Beep Gap OFF Character.....	6-36
Defaults .....	6-37
<i>Command</i> : Enable/Disable No-Gap Hang Workaround.....	6-38
Single Tone Page Messages.....	6-39
Control Character .....	6-39
Format.....	6-39
Pre-Message Delays.....	6-39
Inter-Page Delays.....	6-39
Message Level .....	6-39
<i>Command</i> : Select Inter-Page Delay.....	6-40
Two-Tone Sequential Page Messages .....	6-41
Control Character .....	6-41
Format.....	6-41
Pre-Message Delays.....	6-41
Inter-Page Delays.....	6-42
Message Level .....	6-42
Five/Six-Tone Page Messages .....	6-43
Control Character .....	6-43
Format.....	6-43
Pre-Message Delays.....	6-43
Inter-Page Delays.....	6-43
Message Level .....	6-44
DTMF Page Messages.....	6-45
Control Character .....	6-45
Format.....	6-45
Pre-Message Delays.....	6-45
Inter-Page Delays.....	6-45
Message Level .....	6-45
Defaults .....	6-45
DTMF Characters.....	6-46
DTMF Duration Change Characters.....	6-46
DTMF Custom Duration Change Characters.....	6-47
DTMF Gap Change Characters .....	6-47
DTMF Custom Gap Change Characters .....	6-48
DTMF Pause Characters .....	6-48



DTMF Custom Pause Characters .....	6-49
DTMF Custom Changes (Duration ~ Gap ~ Pause) .....	6-49
DTMF Character Set Tables Explained .....	6-50
Examples .....	6-50
<i>Command: Select Default DTMF Durations</i> .....	6-52
SELCAL Page Messages .....	6-53
Control Character .....	6-53
Format .....	6-53
Pre-Message Delays .....	6-54
Inter-Page Delays .....	6-54
Message Level .....	6-54
Speech Messages .....	6-55
Control Character .....	6-55
Format .....	6-55
Primary/Secondary (Interruptable) Speech Messages .....	6-55
Pre-Message Delays .....	6-56
Intra-Message Delays .....	6-56
Message Level .....	6-56
Speech Vocabulary .....	6-56
Tone Codes .....	6-57
Tone Code Table Explained .....	6-57
Calculating Tone Codes .....	6-57
Plectron Tone Code Table .....	6-57
Run-Time Variables .....	6-58
Clock and Calendar RTVs .....	6-58
Datatype RTVs .....	6-60
Miscellaneous RTVs .....	6-62
<i>Command: Select/Review/Play User Messages</i> .....	6-63
<i>Command: Send Message</i> .....	6-65
<i>Command: Copy Message</i> .....	6-67
<i>Command: Select/Review Warm-Reset Message</i> .....	6-68
<i>Command: Stop a Speech Message In Progress</i> .....	6-69
<b>DTMF Decoder .....</b>	<b>7-1</b>
Effects of COR and CTCSS Filtering on DTMF Decoders .....	7-3
DTMF Decoder Access Mode .....	7-3
<i>Command: Select DTMF Decoder Access Mode</i> .....	7-5
DTMF Decoder Anti-Falsing Timer .....	7-6
<i>Command: Select DTMF Decoder Anti-Falsing Timer</i> .....	7-7
DTMF Decoder Interdigit Timer .....	7-8
<i>Command: Select DTMF Decoder Interdigit Timer</i> .....	7-9
Command Execution on DTMF Interdigit Timer .....	7-10
<i>Command: Enable/Disable Command Execution on Interdigit Timer</i> .....	7-11
End-of-Transmission Command Execution .....	7-12
<i>Command: Enable/Disable End-of-Transmission Command Execution</i> .....	7-13
4 <sup>th</sup> Digit Command Execution .....	7-14
<i>Command: Enable/Disable Execute Command on 4<sup>th</sup> Digit</i> .....	7-15
DTMF Decoder Disconnect Timer .....	7-16
<i>Command: Enable/Disable DTMF Decoder Disconnect Timer</i> .....	7-17
<i>Command: Select DTMF Decoder Disconnect Timer</i> .....	7-18
DTMF Mute .....	7-19
<i>Command: Enable/Disable DTMF Decoder Mute</i> .....	7-20
DTMF Mute Hang Time .....	7-21
<i>Command: Select DTMF Decoder Mute Hang Time for 1<sup>st</sup> Digit, *, # and LongTone</i> .....	7-22

<i>Command: Select DTMF Decoder Mute Hang Time for Other Digits</i> .....	7-23
DTMF Mute Bypass .....	7-24
<i>Command: Enable/Disable DTMF Mute Bypass</i> .....	7-25
DTMF Cover Tone .....	7-26
<i>Command: Select DTMF Cover Tone Interval</i> .....	7-27
<i>Command: Select/Review DTMF Cover Tone Message</i> .....	7-28
Any Character Macro .....	7-29
<i>Command: Select DTMF Decoder Any-Character Macro</i> .....	7-30
Long Tones .....	7-31
<i>Command: Enable/Disable DTMF Long Tones</i> .....	7-32
<i>Command: Select DTMF Long Tone Timer</i> .....	7-33
<i>Command: Select DTMF Long Tone Macros</i> .....	7-34
<i>Command: Select DTMF Any Long Tone Macro</i> .....	7-36
Command Response Messages .....	7-37
<i>Command: Enable/Disable Command Response Messages</i> .....	7-38
<i>Command: Enable/Disable Command Responses In Macros</i> .....	7-39
<i>Command: Enable/Disable OK Command Response Messages</i> .....	7-40
<i>Command: Enable/Disable Error Command Response Messages</i> .....	7-41
<i>Command: Select/Review Programmable Command Response Messages</i> .....	7-42

## **Serial** ..... **8-1**

Overview .....	8-1
Serial Port Configuration .....	8-2
Console Port Default .....	8-2
Auxiliary (Aux) Port Default .....	8-2
Changing the Defaults .....	8-2
Changing the Console Port Baudrate .....	8-3
Changing the Auxiliary Port Baudrate .....	8-4
Changing the Port Assignments .....	8-5
Cold Start Effects, None .....	8-5
Flow Control, None .....	8-5
Cabling .....	8-6
Terminal Emulator .....	8-7
<i>Command: Reset Console Defaults</i> .....	8-8
Entering Commands on the Console Port .....	8-9
Entering Commands .....	8-10
Command Responses .....	8-10
Audio Responses .....	8-10
Controller Command Format .....	8-11
ASCII Commands .....	8-11
DTMF-Compatible Commands .....	8-12
Spaces .....	8-12
Comments .....	8-12
Sending a Prewritten Text File of Commands to the 7330 .....	8-13
Remote Front Panel .....	8-14
Polling Front Panel Status .....	8-16
File Management .....	8-18
SBOOT Version .....	8-19
Managing the Controller Time-of-Day Clock .....	8-19
Managing the Controller Configuration .....	8-19
Managing Files .....	8-20
Displaying Firmware File Information .....	8-20
Erasing A File .....	8-21
Transfer a File to Controller Flash Storage from a PC .....	8-22

Configuring the Serial Ports.....	8-23
Boot/Run a Program.....	8-23
Battery Status.....	8-24
Other Warnings.....	8-24
Configuration Management.....	8-25
What's it good for? .....	8-25
Managing the Controller Configuration.....	8-26
Displaying Stored Configurations.....	8-27
Saving Your Active Configuration.....	8-27
Restoring A Saved Configuration.....	8-28
Erasing A Saved Configuration.....	8-29
Transfer a File to Controller Flash Storage from a PC .....	8-29
Transfer a File to a PC from Controller Flash Storage .....	8-30
S-COM Configuration Utility.....	8-31
Running the Command.....	8-31
The Generated Report.....	8-32
The Generated Script .....	8-40

## **Paths..... 9-1**

Path Enable/Disable .....	9-3
Path Access Mode.....	9-3
<i>Command:</i> Enable/Disable Path.....	9-6
<i>Command:</i> Select Path Access Mode.....	9-7
<i>Example:</i> Configure Receiver Paths to a Transmitter.....	9-8
Path Priority.....	9-9
<i>Command:</i> Select Path Priority .....	9-10
Introduction to Path Timeout Timers.....	9-11
Enable/Disable Path Timeout Timer .....	9-12
<i>Command:</i> Enable/Disable Path Timeout Timer .....	9-13
Path Timeout Value.....	9-14
<i>Command:</i> Select Path Timeout Timer .....	9-15
Path Penalty Time Value .....	9-16
<i>Command:</i> Select Path Timeout Penalty Timer .....	9-17
Reset Path Timeout Timer.....	9-18
<i>Command:</i> Reset Path Timeout Timer .....	9-19
Path Timeout Messages .....	9-20
<i>Command:</i> Select/Review Timeout Messages.....	9-21
<i>Command:</i> Select/Review Timeout End Messages.....	9-22
Path Timeout Macros.....	9-23
<i>Command:</i> Select Timeout Macros.....	9-24
<i>Command:</i> Select Timeout End Macros.....	9-25
Path Courtesy Message.....	9-26
<i>Command:</i> Select/Review Courtesy Messages.....	9-27
Path Courtesy Macro .....	9-28
<i>Command:</i> Select Courtesy Macros.....	9-29
Introduction to Start of Activity and End of Activity Macros .....	9-30
<i>Command:</i> Select Path Start-of-Activity and End-of-Activity Macros.....	9-31
<i>Command:</i> Select Path End-of-Activity Counter and Timer.....	9-32
<i>Example:</i> Temporarily Change The Access Mode.....	9-34

<b>Receiver Commands .....</b>	<b>10-1</b>
Front Panel COR and CTCSS LEDs .....	10-2
COR Filter .....	10-3
<i>Command: Select COR Filter Delay .....</i>	10-4
CTCSS Filter .....	10-5
<i>Command: Select CTCSS Filter Delay .....</i>	10-6
Anti-kerchunker .....	10-7
<i>Command: Enable/Disable Anti-kerchunker .....</i>	10-8
<i>Command: Select Anti-kerchunk Key-Up Delay .....</i>	10-9
<i>Command: Select Anti-kerchunk Rearm-Up Delay .....</i>	10-10
<i>Command: Enable/Disable Anti-kerchunk No Hangtime Mode .....</i>	10-11
Flutter Filter .....	10-12
<i>Command: Select Flutter Filter Timer .....</i>	10-13
Audio Delay and Audio Gate Delay .....	10-14
<i>Command: Select Audio Gate Delay .....</i>	10-15
COR/CTCSS Simulate Software Switches .....	10-16
<i>Command: Simulate COR/CTCSS Active .....</i>	10-17
COR/CTCSS Event-Triggered Macros .....	10-18
<i>Command: Assign Macros To COR Inputs .....</i>	10-19
<i>Command: Assign Macros To CTCSS Inputs .....</i>	10-20
COR Pulse-Triggered Macros .....	10-21
<i>Command: Select COR Pulse-Triggered Macros .....</i>	10-23
<i>Command: Select COR PTM Minimum Pulse Duration .....</i>	10-25
<i>Command: Select COR PTM Maximum Gap Duration .....</i>	10-26
Receiver Enable/Disable .....	10-27
<i>Figure: Receiver and Path Enable/Disable Controls .....</i>	10-27
<i>Command: Enable/Disable Receiver .....</i>	10-28
 <b>Transmitter Commands .....</b>	 <b>11-1</b>
Front Panel PTT LEDs .....	11-2
Transmitter Tail Sequence .....	11-3
<i>Figure 11-1: Transmitter Tail Sequence .....</i>	11-3
<i>Tip: Setting Transmitter Tail Timing .....</i>	11-4
Transmitter Turn-On Message Delay .....	11-5
<i>Command: Select Transmitter Turn-On Message Delay .....</i>	11-6
Courtesy Delay .....	11-7
<i>Command: Select Courtesy Delay .....</i>	11-8
Courtesy Delay Violation Macro .....	11-9
<i>Command: Assign Courtesy Delay Violation Macro .....</i>	11-10
Dropout Delay .....	11-11
<i>Command: Select Dropout Delay .....</i>	11-12
Dropout Message, Dropout Message Time .....	11-13
<i>Command: Select/Review Dropout Message .....</i>	11-14
<i>Command: Select Dropout Message Time .....</i>	11-15
Dropout Macro .....	11-16
<i>Command: Assign Dropout Macro .....</i>	11-17
PTT Unkey Delay .....	11-18
<i>Command: Select Transmitter PTT Minimum Unkey Delay .....</i>	11-19
PTT Macros .....	11-20
<i>Figure: Transmitter PTT-Triggered Macros .....</i>	11-20
<i>Command: Assign Transmitter PTT Macros .....</i>	11-21

Start-of-Activity and End-of-Activity .....	11-22
<i>Command</i> : Select Transmitter End-of-Activity Counter and Timer .....	11-23
<i>Command</i> : Select Transmitter Start-of-Activity and End-of-Activity Macros .....	11-24
Enable/Disable Transmitter PTT .....	11-25
<i>Command</i> : Enable/Disable Transmitter PTT .....	11-26
Key Transmitter, Timed .....	11-27
<i>Command</i> : Key Transmitter (Timed) .....	11-28
Key Transmitter, Untimed .....	11-29
<i>Command</i> : Key Transmitter (Untimed) .....	11-30
Key Path-to-Transmitter Macro .....	11-31
<i>Command</i> : Assign Path-to-Transmitter-Triggered Macros .....	11-32
Transmitter Tone Generator .....	11-33
<i>Command</i> : Control Transmitter Tone Generator .....	11-34
<b>Identifier .....</b>	<b>12-1</b>
Identifier Sequence (On-Demand).....	12-2
<i>Command</i> : Select Identifier Message Interval .....	12-3
<i>Command</i> : Select Identifier Pending Interval .....	12-4
<i>Command</i> : Select/Review Identifier Messages .....	12-5
<i>Command</i> : Select Identifier-Triggered Macros .....	12-7
<i>Command</i> : Send Initial ID Message .....	12-8
<i>Command</i> : Send Normal ID Message .....	12-9
<i>Command</i> : Select Initial and Normal ID Tail Messages.....	12-10
<i>Example</i> : % <del>R</del> Periodic+or % <del>B</del> Beacon+ID .....	12-11
<b>CTCSS Encoders .....</b>	<b>13-1</b>
<i>Command</i> : Control CTCSS Encoder .....	13-2
<i>Example 1</i> : Encoder follows PTT .....	13-3
<i>Example 2</i> : Eliminate squelch noise burst (chicken-burst).....	13-3
<i>Example 3</i> : Allow brief monitoring of QSOs in progress.....	13-4
<i>Example 4</i> : Encoder follows COR.....	13-4
<i>Example 5</i> : Encoder follows COR plus part of tail.....	13-4
<i>Example 6</i> : Macro Control of CTCSS Encoder.....	13-4
<i>Command</i> : Select Frequency of CTCSS Encoder.....	13-5
<i>Table</i> : CTCSS Encoder Frequencies .....	13-6
<i>Command</i> : Select CTCSS ON Time.....	13-7
<i>Command</i> : Select CTCSS Reverse Burst Time .....	13-8
<i>Command</i> : Select CTCSS Encoder-Triggered Macros .....	13-9
<i>Command</i> : Enable/Disable CTCSS Encoder Controls CTCSS Logic Output.....	13-10
<i>Command</i> : Enable/Disable CTCSS Encoder In Anti-Kerchunker No-Hangtime Mode ..	13-11
<b>Logic Inputs .....</b>	<b>14-1</b>
<i>Command</i> : Assign Macro To Logic Input .....	14-2
<i>Examples</i> : monitoring site equipment .....	14-3
<b>Logic Outputs .....</b>	<b>15-1</b>
<i>Command</i> : Select Logic Outputs .....	15-3
<i>Examples</i> : controlling site equipment.....	15-4
<i>Command</i> : Select Logic Output Momentary Timer .....	15-5
<i>Command</i> : Select Logic Output Inversion.....	15-6
<b>A-to-D Converter.....</b>	<b>16-1</b>
<i>Command</i> : Select Analog Input Range .....	16-3

<b>Software Switches</b> .....	<b>17-1</b>
Software Switch Numbering.....	17-2
Setting and Clearing Software Switches.....	17-2
<b>Counters</b> .....	<b>18-1</b>
Counter Numbering.....	18-2
Select a Counter Reload Value.....	18-2
<b>Timers</b> .....	<b>19-1</b>
Overview.....	19-1
Timer Numbering.....	19-1
Exceptions to Range.....	19-2
Selecting a Timer Value.....	19-2
<b>User Timers</b> .....	<b>20-1</b>
<i>Command:</i> Select Timeout Value.....	20-2
<i>Command:</i> Select Timer Event Macro.....	20-3
<i>Command:</i> Stop Timer.....	20-4
<i>Command:</i> Start Timer (Retriggerable).....	20-5
<i>Command:</i> Start Timer (One-Shot).....	20-6
<i>Example:</i> Fan Control.....	20-7
<i>Example:</i> An Activity Timer.....	20-8
<i>Example:</i> Time-Spaced Macros.....	20-9
<i>Example:</i> Timed Disable of DTMF Mute.....	20-10
<b>Clock and Calendar</b> .....	<b>21-1</b>
<i>Command:</i> Set Clock and Calendar.....	21-2
<i>Example:</i> Setting the time.....	21-3
<i>Command:</i> Adjust Daylight Saving Time.....	21-4
<i>Example:</i> Using the Scheduler to adjust the time.....	21-5
<i>Command:</i> Reset Clock Seconds.....	21-6
<i>Command:</i> Adjust Clock Seconds.....	21-7
<i>Example:</i> Improving the accuracy of the clock over long periods of time.....	21-7
<i>Command:</i> Enable/Disable Automatic Daylight Saving Time Adjustment.....	21-9
<b>Scheduler</b> .....	<b>22-1</b>
<i>Command:</i> Enable/Disable Scheduler.....	22-2
<i>Command:</i> Create Setpoint.....	22-3
<i>Table:</i> Scheduler Day Codes.....	22-4
<i>Example:</i> Creating Setpoints.....	22-5
<i>Example:</i> Play A Top-Of-The-Hour Message.....	22-6
<i>Command:</i> Enable/Disable One or More Setpoints.....	22-7
<i>Command:</i> Delete One or More Setpoints.....	22-8
<b>Custom Audio Library</b> .....	<b>23-1</b>
Audio File Format Conversion.....	23-3
File Formats and Recording Settings.....	23-3
File Tools.....	23-3
Getting Started.....	23-4
Create a Working Directory.....	23-4
Get the Latest S-COM Release.....	23-4
Sample Files.....	23-5

BuildSpeechLib.exe.....	23-5
Filenames .....	23-5
Taking Care of Your Files.....	23-6
Building a Custom Audio Library .....	23-7
What the Utility Does.....	23-8
Utility Output Example, Successful.....	23-9
Utility Output Example, Cannot Find Input Files .....	23-9
Downloading Your Custom Audio Library to the Controller .....	23-10
Using Your Custom Audio Library .....	23-10
Using SoX.....	23-11
Downloading SoX.....	23-11
Installing SoX.....	23-11
Converting Files Using SoX.....	23-11
Generating Audio Test Files Using SoX.....	23-12
Using Audacity® .....	23-13
Downloading Audacity .....	23-13
Installation of Audacity .2.6 or Similar Versions .....	23-13
<i>Example 1: Converting an existing .wav file into an S-COM Custom Audio File.....</i>	23-19
Verify The File.....	23-21
<i>Example 2: Recording audio and saving as an S-COM Custom Audio File .....</i>	23-22

## **Programming Tables ..... A-1**

Table of Contents .....	A-2
Message Levels.....	A-3
Message Control Characters .....	A-4
CW Character Set Tables .....	A-5
Single-Tone Beep Character Set Tables .....	A-7
Dual-Tone Beep Character Set Tables.....	A-10
DTMF Character Set Tables .....	A-12
SELCAL Character Set Table .....	A-15
Speech Character Set Tables .....	A-16
Speech Message Level Change .....	A-16
Speech Message Delay .....	A-16
Speech Vocabulary Tables .....	A-17
Numbers.....	A-17
Letters .....	A-17
Calendar.....	A-18
Measurements.....	A-18
All Words Alphabetic Listing.....	A-19
Message Run-Time Variables .....	A-29
Scheduler Day Code Table .....	A-30
Tone Code Table .....	A-31
Root Numbers (Commands) by Number .....	A-34
Event Macros by Number .....	A-36
Messages by Number .....	A-39
10 Millisecond Timers by Number .....	A-41
100 Millisecond Timers by Number .....	A-43
1 Second Timers by Number .....	A-44
Path Access Mode by Number .....	A-45
Software Switches by Number .....	A-46
Counters by Number .....	A-49
Booleans by Number .....	A-50
CTCSS Tone Numbers .....	A-52
Command Quick Reference.....	A-53

<b>Installation .....</b>	<b>B-1</b>
Introduction .....	B-1
Static Warning! .....	B-1
Front Panel LEDs.....	B-2
Cables .....	B-2
Jumpers . Storing Them.....	B-3
Receiver COR .....	B-4
Receiver CTCSS .....	B-5
Transmitter PTT.....	B-6
Setting Audio Levels.....	B-7
<i>Figure: Audio Path Setup Details</i> .....	B-7
Receiver Audio .....	B-8
Transmitter Audio .....	B-10
CTCSS Encoder .....	B-12
Tone/Speech Levels.....	B-13
Control Receiver.....	B-13
DC Power Requirements.....	B-14
Logic Inputs .....	B-15
Logic Outputs.....	B-16
A-to-D Inputs.....	B-17
Board Silkscreen.....	B-18
Radio Port Connectors.....	B-19
I/O Connector .....	B-20
RS-232 Connector .....	B-21
Potentiometers.....	B-22
Jumpers.....	B-23
Test Points.....	B-25
Testing the Transmitter Interface .....	B-26
Testing the Receiver Interface .....	B-26
Testing The DTMF Decoder.....	B-27
Local Control .....	B-27
Performing the Tests .....	B-27
Falsing.....	B-28
Battery Replacement .....	B-29
Introduction.....	B-29
Replacement Procedure .....	B-29
<b>Specifications .....</b>	<b>E-1</b>
Introduction.....	E-1
Receiver and Transmitter Ports.....	E-2
Tone Generators.....	E-3
CTCSS Encoders.....	E-4
Logic Inputs .....	E-5
Logic Outputs.....	E-5
A/D Inputs.....	E-5
Clock/Calendar .....	E-5
Memory .....	E-6
Battery .....	E-6
DC Power .....	E-6
Cabinet .....	E-7
Hardware .....	E-8



# Tables/Figures

## A

Analog to Digital Converter .....	16-1
Audio Levels, Setting .....	B-7

## B

Beep, Single-Tone Duration Change Characters .....	6-26, A-7
Beep, Single-Tone Factory-Fixed Frequency .....	6-23, A-6
Beep, Single-Tone Gap Change Characters .....	6-25, A-7
Beep, Single-Tone Message Level Change Characters.....	6-19, A-7
Beep, Single-Tone Owner-Fixed Frequency .....	6-24, A-6
Beep, Single-Tone Parameters (General) .....	6-22, A-8
Beep, Dual-Tone Duration Change Characters .....	6-36, A-7
Beep, Dual -Tone Factory-Fixed Frequency .....	6-33, A-6
Beep, Dual -Tone Gap Change Characters .....	6-35, A-7
Beep, Dual -Tone Message Level Change Characters .....	6-19, A-7
Beep, Dual -Tone Owner-Fixed Frequency .....	6-21, A-6
Beep, Dual -Tone Parameters (General) .....	6-33, A-8
Booleans by Number.....	3-11, A-48
Board Silkscreen.....	B-18

## C

Command Quick Reference .....	A-51
Connectors, Radio Port.....	B-15
Connectors, I/O.....	B-16
Counters by Numbers .....	3-13, A-47
CTCSS Encoder Frequency .....	13-6
CW Alphanumeric Characters .....	6-16, A-4
CW Frequency Change Characters.....	6-17, A-5
CW Message Level Change Characters.....	A-5
CW Punctuation and Related Characters .....	6-14, A-5
CW Speed .....	6-17
CW Speed Change Characters .....	6-15, A-4

## D

DTMF Characters .....	6-46, A-11
DTMF Custom Changes (Duration ~ Gap ~ Pause) .....	6-49, A-13
DTMF Duration Change Characters .....	6-46, A-11
DTMF Gap Change Characters .....	6-47, A-12
DTMF Pause Characters .....	6-48, A-12
Dual-Tone Beep Duration Change Characters .....	6-34, A-10
Dual-Tone Beep, Factory-Fixed Frequency .....	6-31, A-9
Dual-Tone Beep Gap Change Characters .....	6-33, A-10
Dual-Tone Beep, Message Level .....	A-10
Dual-Tone Beep Parameters.....	6-30, A-9

## E

Event Macros by Number .....	3-18, A-35
------------------------------	------------

<b>F</b>	
Front Panel .....	2-3,10-2, 11-2, B-2, B-15, B-16
<b>G</b>	
<b>H</b>	
<b>I</b>	
Input/Output Connector .....	B-20
Interruptable Message Control Characters .....	6-9
<b>J</b>	
Jumpers .....	B-23
Jumpers, Receiver .....	B-6
Jumpers, Transmitter .....	B-8
<b>K</b>	
<b>L</b>	
LEDs, Front Panel.....	2-3,10-2, 11-2, B-2, B-15, B-16
LEDs, Radio Port .....	2-3, 10-2, 11-2, B-2
LEDs, Logic Inputs.....	2-4, B-15
LEDs, Logic Outputs.....	2-5, B-16
<b>M</b>	
Message Control Characters .....	6-3, A-3
Message Levels .....	6-10, A-2
Message Run-Time Variables .....	6-54, A-28
Messages by Number .....	A-38
<b>N</b>	
<b>O</b>	
<b>P</b>	
Paths .....	3-2
Path Access Mode by Number .....	A-44
Path Enable/Disable .....	9-3, 10-27
Path Numbers.....	3-2
Potentiometers.....	B-22
Power, DC Requirements.....	B-14
<b>Q</b>	
<b>R</b>	
Radio Port Connectors.....	B-19
Receiver Enable/Disable.....	9-3, 10-27
Root Numbers (Commands) by Number .....	A-33
Run-Time Variables, Message .....	6-58
RS-232 Connectors.....	B-21

**S**

Scheduler Day Code Table ..... 22-3, A-29  
 SELCAL Character Table ..... 6-53, A-14  
 Serial Port, RS-232 Connectors ..... B-17  
 Serial Port, Configuration..... 8-1  
 Silkscreen, Board..... B-18  
 Software Switches by Number ..... A-45  
 Speech, Message Level Change Characters..... A-15  
 Speech Vocabulary, All Words Alphabetic Listing ..... A-18  
 Speech Vocabulary, Calendar..... A-17  
 Speech Vocabulary, Letters ..... A-16  
 Speech Vocabulary, Measurements..... A-17  
 Speech Vocabulary, Numbers..... A-16  
 Switches, Software, by Number ..... 3-9, A-35

**T**

Telephone Line Suppressors Market Sources ..... B-13  
 Test Points..... B-25  
 Test Points, Receiver..... B-9  
 Timers, 10 Millisecond, by Number ..... 3-15, A-40  
 Timers, 100 Millisecond, by Number ..... A-42  
 Timers, 1 Second, by Number ..... A-43  
 Tone Code Table ..... 6-57, A-30

**U**

**V**

**W**

**X**

**Y**

**Z**

**Notes:**

---

## *Chapter 1*

# Product Description

---

The S-COM 7330 is a high-quality, compact, microprocessor-based repeater controller intended for use in amateur radio and commercial installations. Incorporating advanced hardware and software designs, the 7330 provides most-often-needed control functions and powerful new features not found in any comparably priced controller.

- The 7330 is fully remotely programmable via DTMF commands over the receiver ports, and locally programmable over an RS-232 port — eliminating the inconvenience of returning EPROMs, microcontroller ICs, and boards to the factory for reprogramming.
- No jumpers or diodes are used for programming.
- Data is retained in non-volatile memory, ensuring that no information is lost during power outages and eliminating extra trips to the repeater site.

## **Standard Hardware Features**

### **Configuration**

The standard 7330 controller package consists of a main board and an LED display board mounted in a 1U cabinet, a set of mating connectors, and a manual on CD. No options are required to perform the most-often-needed repeater control functions.

### **Cabinet**

The 1U (single-height) cabinet can be installed in a standard 19" wide equipment rack. The cabinet is constructed of three parts: An iridite-plated chassis box, an iridite-plated chassis cover, and a black front display panel.

The complete assembly is only 1-3/4" high and 7" deep, allowing installation in any rack (including slim Motorola racks).

### **Main Board**

The *7330 Main Board* measures 6" deep by 16" wide and operates as a stand-alone controller. The digital portion of the board contains the microprocessor, memory, logic input/output, and real-time clock circuits. The analog portion contains DTMF decoders, audio switches, tone and stored audio D/As, and audio interface circuits. Seven connectors (four DE9S, one DE9P, one DB25S and one locking power jack) are mounted on the main board. These connectors protrude through cutouts in the rear of the cabinet, making the interior of the cabinet free of wiring.

## **Standard Software Features**

### **Identifier**

The software *Identifier* stores remotely-programmable multiple callsigns with ID tail messages. Time between identifications is also programmable. CW is internally mixed with repeat audio. The ID'er is *polite*, and attempts to identify during breaks between transmissions.

### **Messages and Paging Formats**

Most *Messages* are remotely programmable. CW pitch and speed are programmable, and can be changed within a message. The character set includes alphanumerics, punctuation, and a large library of "*Single-Tone Beeps*" and "*Dual-Tone Beeps*." CW level can be adjusted remotely.

The 7330 supports the following paging formats: Single-tone (group call), two-tone sequential, 5/6-tone, SELCAL, and DTMF . Pages may be stacked for convenient call-up of ARES members, weather spotters, DX club members, on-the-air meetings, etc.

### **Timers**

All timers in the 7330 are derived from a crystal-controlled clock for improved accuracy over other methods. Most timers are remotely programmable, including: *Courtesy Delay*, *Dropout Delay*, and *Timeout*.

### **Repeater Characteristics**

The character of a repeater can be varied with choices of *Courtesy Messages*, *Dropout Messages*, *Timeout Messages*, and their associated timers. The repeater can be placed into one of several access modes, or disabled. Repeater characteristics can be changed by either a command or a transition on one of the logic inputs.

## **Clock and Calendar**

Time and date information may be obtained by inserting one or more *Run-Time Variables* into any programmable message. CW and voice readout are available from the main board.

A 100-setpoint *Scheduler* executes commands at programmable times and dates.

## **Logic Inputs and Outputs**

Logic inputs are used to detect a change of state in monitored devices at the repeater site. Logic outputs can be pulsed or latched to control a device at the site.

## **A-to-D Inputs**

A-to-D inputs can be programmed to measure and report changes in analog values at the repeater site including battery voltage, temperature, and received signal strength.

## **Command Language**

Commands are given to the 7330 with an easy-to-use DTMF language. Security is enhanced with a *Password (PW)* system, as well as programmable restrictions on DTMF decode operation. A library of *Macros* may be defined for repeater users. Macros may be created, deleted, renamed, and modified at any time by authorized programmers.

**Notes:**



---

## *Chapter 2*

# Getting Started

---

We'll now assume your controller is connected to either a real or a simulated repeater. (For ideas on a simulator, see the next page.)

You'll probably want to change some of the default conditions soon after installing the controller, so this is a good time to discuss initialization, defaults, and initial programming.

For example, the default identification message after an initialization is simply the CW letters `%D+`. You'll want to change that message to the repeater callsign. You may also want to change such things as the time between identifications, the master password, and the repeater access mode.

If you wish, you can program the controller on your workbench and move it to the repeater site later.

---

**Note:** Place the controller in an antistatic bag before transporting it. Electrostatic discharges can damage components and destroy data stored in memory.

---

## Testing On The Bench

### What Does It Take?

You can simulate a repeater on the bench pretty easily. There's only a few components required that you may already have in your shop. You can use this setup to become familiar with the operation of your new controller and to get your programming just right before taking it to your site.

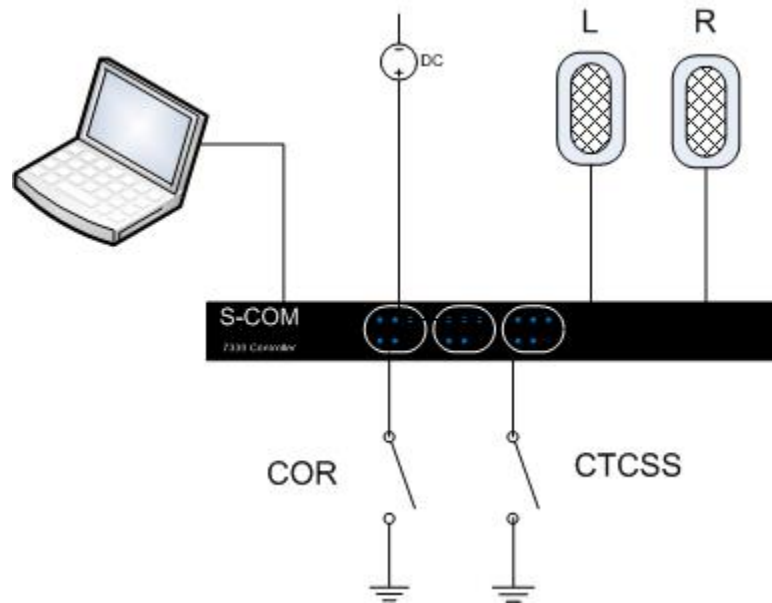

On one or more of the port connectors, add the following connections (see rear panel view in the Installation Appendix, page B-19):

- Wire the power connector to a source of 9-36 volts of at least 190 milliamps. (See Installation Appendix, page B-14.) Most any DC wall transformer power pack will do the job.
- Wire toggle switches to the COR and CTCSS inputs. (See Installation Appendix, pages B-4 and B-5.)
- Wire a powered computer speaker to the transmitter audio output #1. If you have a set of stereo speakers, wire the other channel to transmitter audio output #2. This second transmitter connection is useful for experimenting with path and audio routing commands. (See Installation Appendix, page B-10.)
- Optionally, wire an LED and series resistor to the PTT output. (See Installation Appendix., page B-6.)
- Optionally, wire a DTMF keypad to the receiver audio input. (See Installation Appendix, page B-8.)

If you don't have a DTMF keypad, you can enter commands on the serial port instead. Connect the serial cable that came with your controller from your PC to the controller's RS-232 port on the connector marked RS232-2. (See Serial Port Commands, chapter 8.) Any tones or speech that you play will come out on the transmitter #1 audio output.

Next, do a quick check of your wiring by powering up the controller:

- When you close a toggle switch, the corresponding COR or CTCSS LED should turn on and the controller should key the PTT and light the PTT LED.
- When you power cycle the controller, the controller should speak the firmware version on the transmitter #1 audio output so that you can hear it on the powered speaker.
- If you have a DTMF keypad connected to the controller, toggle the switch attached to the COR input so that the LED is on, then press any DTMF key. The DTMF LED for that port should come on.

Now you're ready to experiment with the programming.

## Front Panel

The controller has front panel LEDs that show you the status of supply power, each radio port's signals, logic inputs, logic outputs and SBOOT mode.

### Radio Port

The front panel display includes a blue LED for each radio port's COR and CTCSS input, the PTT logic output, DTMF decode status, and CTCSS Encoder status.

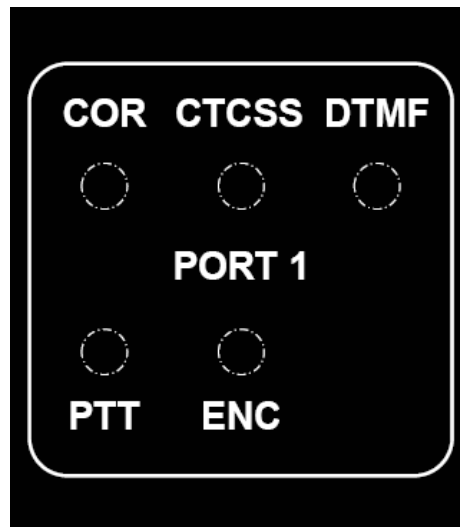

LED	State	Description
COR	ON	Active
	OFF	Not Active
CTCSS	ON	Active
	OFF	Not Active
COR and CTCSS	Alternate Flashing	Receiver Disabled
DTMF	ON	Decoding Tone
	OFF	Idle
PTT	ON	Keying
	OFF	Not Keying
	Flashing	Transmitter Disabled
ENC (Encoder)	ON	Active
	OFF	Not Active

For COR, CTCSS, and PTT, the meaning of *Active/Not Active* depends on whether inversion jumpers are installed at J31 and J32. See the Installation Chapter, starting on page B-1 for more details.

## Logic Inputs

The front panel display includes a blue LED for each logic input on the controller.

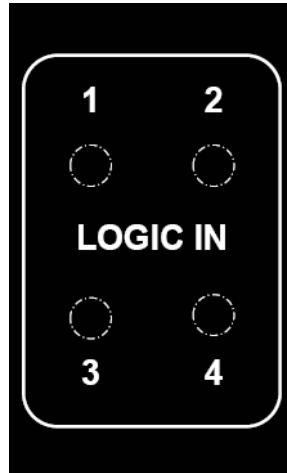

LED	State	Description
Logic Input	ON	Active
	OFF	Not Active

For logic inputs, *Active* means that the logic input pin is being driven to ground. For more information, see the Installation Chapter, page B-15.

## Logic Outputs

The front panel display includes a blue LED for each logic output on the controller.

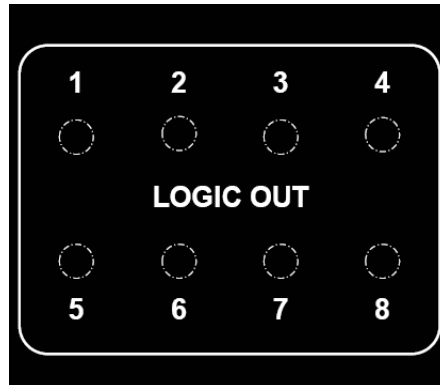

LED	State	Description
Logic Output	ON	Active
	OFF	Not Active

For logic outputs, the meaning of *Active/Not Active* depends on whether the inversion software switch has been set. For more information, see the Installation Chapter, page B-16, and the Select Logic Inversion command on page 15-6.

## Supply Power

The front panel display includes a green LED that glows when supply power is powering the controller. This LED cannot be turned off without removing power from the controller. (See the Installation Chapter, page B-14.)

## SBOOT Mode

The blue LEDs on the front panel display will scan quickly left-to-right when the SBOOT management program is running in the controller. When the controller is in this mode, the LEDs are flashed as a warning that the repeater is not operating. Exit this mode for repeater operation. (See page 8-16.)

## Security and Power Savings

The blue LEDs on the front panel display can be turned off during operation to provide security for the physical status of the controller. Turning off the LEDs also reduces the power consumption of the controller by a small amount. (See the Security Chapter, page 4-6.)

## Power ON Initialization

### Initializing the Controller

The controller has two pushbuttons on the rear panel, RESET and INIT (initialize).

Each time power is applied, or the RESET pushbutton is pressed, the controller will restart its software program.

The controller checks the INIT pushbutton during the restart process. If it's NOT being pressed, the program will use configuration data previously stored in its *Active Configuration* in battery-backed memory. If it IS being pressed, the program will replace previously-stored configuration data with *Factory Default* information.

---

**Note:** To initialize the controller and erase the active configuration, the RESET pushbutton must be pressed while the INIT pushbutton is pressed. This sequence helps protect your programming from accidental erasure.

---

Controllers are initialized as part of the testing procedure at the factory, but it's a good idea to initialize your controller before programming it to make sure all the default conditions are present as described in this manual.

You may need to do an initialization at other times, such as:

- You've lost or forgotten the programming password.
- You want to erase all programming and start over.
- You've downloaded a new software upgrade.
- You've replaced the lithium battery.

To initialize the controller and erase the active controller configuration back to factory defaults, follow these three steps:

- Press and hold down the INIT pushbutton.
- While holding down the INIT pushbutton, press and release the RESET pushbutton.
- Continue holding down the INIT pushbutton for several seconds after releasing the RESET pushbutton.

In this manual, this sequence is referred to as a *Cold Start* sequence.

---

**Note:** The serial port configuration is *not* cleared when you initialize the controller. This way, you can erase the active configuration remotely. See the *File Management* section of Chapter 8, *Serial (RS-232) Commands*.

---

## Cold Start

An initialization is sometimes called a *cold start*. When a RESET and INIT button-initiated cold start occurs, the controller will speak %S-COM 7330 Version *version number* Cold Reset+on port #1. (For a description of a serial console initiated cold start, see page 8-21.)

## Warm Start

Applying power or pressing the RESET pushbutton without doing an initialization is sometimes called a *Warm Start*. When a Warm Start occurs, the controller will speak %S-COM 7330 Version *version number*+on port #1. You can program the controller to send a different message when a Warm Start occurs.

## Default Condition

After an initialization, the controller's programming is in the *default condition*. Default conditions allow the controller to operate the repeater before you've had a chance to customize it with your programming. You can think of an initialization as a simple *pre-programming* of the controller. Most commands have default conditions. They remain in effect until you change them through programming. Default conditions are included in the command descriptions in this manual.

The most important defaults are described in the table below. These are the items that you need to change, or are likely to want to change, when you get started with your new controller.

Parameter	Cold-Start Default	To Set, See Page
Master Password	99	4-2
Identifier Message	%D+in CW	12-5
Identifier CW Tone Frequency	1500 Hz	6-18
Identifier CW Code Speed	20 wpm	6-19
Identifier Interval	3 minutes	12-3
Path Courtesy Message	various beeps, 60 ms	9-26
Path Timeout Timer	3 minutes	9-14
Enable/Disable Path	all receivers to all transmitters	9-3
Path Access Mode of Receivers to Transmitters	carrier access	9-3
DTMF Decoder Access Mode	carrier access	7-3
Transmitter Dropout Delay	3 seconds	11-3, 11-11
Set Clock and Calendar	not cleared on cold start, set to UTC-7 (UTC-6 during Daylight Saving Time in the U.S.) during initial manufacture	21-2



## Quick-Start Setup

In this section, we'll walk you through setting up the basic configuration so that you can start using the 7330 controller right away.

### Set the Master Password

The default Master Password is 99. To change it to 1234, enter:

```
99 93 1234 *
```

For more information, see the Assign Master Password command on page 4-2.

---

**Note:** In the examples that follow, the ~~99~~+ at the beginning of the command is the Master Password. If you change it to ~~1234~~+, for example, then all examples would show ~~1234~~+ instead of ~~99~~+

---

### Set the Identifier Message

For each transmitter you have connected to your controller, you need to set the Normal Identifier Message. To get started, set the message so it will send your callsign in CW. Lookup the 2-digit numbers in the CW character table on page 6-16.

For example, to program the Transmitter #1 Normal Identifier Message with WA9FBO as the callsign, the digits are 32, 10, 09, 15, 11, and 24:

```
99 31 0110 9900 32 10 09 15 11 24 *
```

To program the Transmitter #2 Normal Identifier Message with WA9FBO as the callsign, the digits are 32, 10, 09, 15, 11, and 24:

```
99 31 0210 9900 32 10 09 15 11 24 *
```

To program the Transmitter #3 Normal Identifier Message with WA9FBO as the callsign, the digits are 32, 10, 09, 15, 11, and 24:

```
99 31 0310 9900 32 10 09 15 11 24 *
```

For more information, see the Select/Review Identifier Messages command on page 12-5.

### Set the Identifier Interval

For each transmitter you have connected to your controller, you need to set the Identifier Interval appropriate to meet the laws of your country. In the US amateur radio service, a repeater is required to identify every 10 minutes of use. If you are in a location that requires a periodic ID instead of an on-demand ID, see page 12-11.

For example, to program the Transmitter #1 Identifier Message Interval to 9.5 minutes (570 seconds), enter:

```
99 09 2106 570 *
```

To program the Transmitter #2 Identifier Message Interval to 9.5 minutes (570 seconds), enter:

```
99 09 2206 570 *
```

To program the Transmitter #3 Identifier Message Interval to 9.5 minutes (570 seconds), enter:

```
99 09 2306 570 *
```

For more information, see the Select Identifier Message Interval command on page 12-3.

### **Set the Path (Receiver) Access Mode**

For each receiver you have connected to your controller, you need to set the Path Access Mode for each path to each transmitter you have connected to your controller. The most common Modes are *No Access*, *Carrier Access*, and *COR-AND-CTCSS*.

For this example, let's assume that you have a repeater with a CTCSS decoder on Port #1, an IRLP Node on Port #2, and Port #3 is unused. This is the command we use to disable paths we don't need. Set the Path Access Mode for each path as follows:

```
99 57 11 3 * ;RX1-to-TX1, COR-AND-PL
99 57 21 1 * ;RX2-to-TX1, Carrier Access
99 57 31 0 * ;RX3-to-TX1, Off
99 57 12 3 * ;RX1-to-TX2, COR-AND-PL
99 57 22 0 * ;RX2-to-TX2, Off
99 57 32 0 * ;RX3-to-TX2, Off
99 57 13 0 * ;RX1-to-TX3, Off
99 57 23 0 * ;RX2-to-TX3, Off
99 57 33 0 * ;RX3-to-TX3, Off
```

For more information, see the Path Access Mode description starting on page 9-3.

## Set the DTMF Access Mode

For each receiver you have connected to your controller, you need to set the DTMF Access Mode for each path to each DTMF Decoder. The most common Modes are *No Access*, *Carrier Access*, and *COR-AND-CTCSS*.

For this example, let's again assume that you have a repeater with a CTCSS decoder on Port #1, an IRLP Node on Port #2, and Port #3 is unused. You only want DTMF commands to be decoded on the repeater. Set the *DTMF Decoder Access Mode* for each DTMF Decoder as follows:

```
99 57 1 3 *      ;RX1-to-DTMF1,  COR-AND-CTCSS
99 57 2 0 *      ;RX2-to-DTMF2,  Off
99 57 3 1 *      ;RX3-to-DTMF3,  COR
```

For more information, see DTMF Decoder Access Mode on page 7-3.

## Set the Transmitter Dropout Delay (Tail Time)

For each transmitter you have connected to your controller, you need to set an appropriate Dropout Delay. For repeater transmitters, a tail time of 4 or 5 seconds is appropriate. For link transmitters or IRLP Nodes, set the tail to zero.

For this example, let's again assume that you have a repeater on Port #1, an IRLP Node on Port #2, and Port #3 is unused. Set the DTMF Decoder Access Mode for each DTMF Decoder as follows:

```
99 09 0101 400 *    ;TX1 Dropout Delay 4.00 seconds
99 09 0201 0 *      ;TX2 Dropout Delay 0.00 seconds
```

For more information, see the Select Dropout Delay command on page 11-11.

## Set the Clock and Calendar

A newly manufactured controller has its clock and calendar set to UTC-7 (UTC-6 during Daylight Saving Time in the U.S.) on the day of manufacture. If you're in a different time zone, you should set the clock and calendar for proper operation of the scheduler and to allow the controller to properly record firmware updates.

To set the clock, you will enter the time and date as described on page 21-2. For example, to set the clock and calendar for Wednesday, January 2, 2013, at 2:15 PM (14:15), enter the following command:

```
99 25 13 01 02 3 14 15 *
```

You may also configure the Daylight Saving Time for your area. For more information, see the Set Clock and Calendar commands starting on page 21-1.

## Try It Out!

It's time to try out your changes. Key the repeater. Watch the Front Panel LEDs to verify that the COR and CTCSS inputs for Port #1 are on and the PTT outputs for Port #1 and #2 are on. When you unkey, the repeater should ID with the callsign you programmed. You will hear the default Courtesy Message unless you changed it, then you will hear your Courtesy Message.

## Where Do You Go From Here?

There are so many things that you can do next. Start simple. Maybe try some messages (see Chapter 6, *Messages*) to experiment with the speech library or new Courtesy Messages.

Here are a few suggestions.

You can play a message on Transmitter #1 that speaks the time by entering this command either as DTMF or on the serial port. (See page 6-58.)

```
99 15 9960 0357 0091 0287 9820 9821 * ; Say time
```

You can add this command to a macro to make it easier to play the message. (See page 5-9.)

```
99 20 0001 99 15 9960 0357 0091 0287 9820 9821 *
```

Then, listen on Transmitter #1 as you type the macro name either on DTMF or on the serial port. In this case, you're executing the macro, which in turn executes the command you programmed into the macro.

```
1 * ; Say time
```

You can turn a Logic Output on and off using the following commands. Watch the LED for Logic Output #1 as you type in these commands either on DTMF or on the serial port. (See page 15-3.)

```
99 70 01 * ; Logic Output 1 On
99 71 01 * ; Logic Output 1 Off
```

You can add each of these commands to a macro to make it easier to turn this output on and off. (See page 5-9.)

```
99 20 0011 99 70 01 * ; Logic Output 1 On
99 20 0010 99 71 01 * ; Logic Output 1 Off
```

Then, watch the LED for Logic Output #1 as you type in the macro name either on DTMF or on the serial port. In this case, you are executing the macro, which in turn executes the command or commands you programmed into the macro.

```
11 * ; Logic Output 1 On
10 * ; Logic Output 1 Off
```

If you need additional tips, send us an e-mail, either directly or via the S-COM Yahoo Group. We are here to help!

**Notes:**

---

## *Chapter 3*

# Programming Fundamentals

---

Compared with other controllers, the 7330's innovative port design . . . and an improved set of programming commands to configure those ports . . . gives it a higher degree of flexibility.

### **Port Control**

The 7330 is called a three-port controller because it can be interfaced to three pairs of receivers and transmitters. While that by itself isn't unusual, the 7330 goes much further in its ability to control those ports.

Internally, the 7330 handles the three receivers and three transmitters as six individual devices. No receiver is hardwired to any transmitter, thus the 7330 doesn't require you to use certain ports for repeaters and certain other ports for links and remote bases. In fact, there's no advantage or disadvantage in using any port for a given task other than that the Cold Start and Warm Start speech messages are sent out transmitter #1. Instead, the 7330 lets you remotely choose (and rearrange later) any receiver or any transmitter for any application. You can use the 7330 to control any combination of repeaters, links, crossband repeaters, remote bases, control receivers, and so on.

Furthermore, when multiple receivers feed a transmitter, you can either prioritize or mix each receiver to the transmitter.

## Paths

To make 7330 programming easier to understand, we use the word **path** to mean the hardware and software resources inside the controller that connect a receiver to a transmitter (and a receiver to its DTMF decoder). You set up, knock down, and change receiver-transmitter configurations by programming these paths.

Certain features that were formerly associated with a receiver or transmitter are now associated with the path that connects them.

For example, the job of a timeout timer is to shut down the repeater transmitter on excessively long transmissions. In a multiport controller, though, that kind of timeout timer would shut down a transmitter with no regard to which receiver caused the offense. Moving the timeout function to the receiver creates a new problem because a timed-out receiver would not feed any of the transmitters to which it is connected. The 7330 solves the problem by having an individual timeout timer on each path. Not only can the owner choose a different timeout value for each receiver-transmitter combination, but a timed-out link would not disable a repeater (or vice-versa) just because they have a common receiver or transmitter.

Besides timeout timers, with a 7330 you can select access modes, courtesy messages, and some other functions on a path basis as well. Other functions haven't changed. For example, the identifier and the dropout message, usually associated with the transmitter, have stayed that way.

The path numbering system uses one digit if the path is between a receiver and its associated DTMF decoder. Two digits are used if the path is between a receiver and a transmitter, with the first digit being the receiver number and the second being the transmitter number.

<b>Path No.</b>	<b>Connects</b>
1	RX1 to DTMF Dec 1
2	RX2 to DTMF Dec 2
3	RX3 to DTMF Dec 3
11	RX1 to TX1
21	RX2 to TX1
31	RX3 to TX1
12	RX1 to TX2
22	RX2 to TX2
32	RX3 to TX2
13	RX1 to TX3
23	RX2 to TX3
33	RX3 to TX3



## Programming

The controller is programmed by sending it *Commands*. A command is a string of characters containing all of the information the controller needs to perform a task. The characters may be in the form of DTMF digits sent to one of the controller's receiver inputs, or serial data sent to its RS-232 programming port.

A standard 12-button DTMF keypad may be used for nearly all commands, with few commands requiring a 16-button keypad. (The fourth column characters, A, B, C, and D, can be used in passwords or macro names to increase the security of the system. See the *Special Keys* section on page 3-7.)

The controller can respond to commands by sending *Acknowledgment Messages (Acknowledgments)* and *Error Messages*. (See page 7-35.) These responses may be disabled if desired using the *Enable/Disable Command Response Messages* command on page 7-36.

There are two types of commands, *Control Commands* and *Macro Commands*. Control Commands perform a single task in the controller. A task might set a timer to a new value, change a message, or create or erase a macro. Macro Commands are groups of commands that can be executed in the order they are stored by entering a single *Macro Name*. Macros are stored within the controller and are available to execute until erased. (An entire chapter, chapter 5, is dedicated to the description of creating, appending to and erasing macros.)

---

**Note:** Numerous *Programming Tables* appear throughout the manual. A collection of the most often used tables can be found in Appendix A (on page A-1). Additionally, all Control Commands used in this book appear in the *Command Quick Reference* on page A-53.

---

## Control Command Structure

All control commands follow this format:

(Password) (Root Number) (Data Digits) (Enter)

A control command always begins with a **Password**, often abbreviated as **%PW)+** in this manual.

The controller supports three passwords: *Master Password*, *Control Operator Password*, and *Macro-Only Password*.

- The default Master Password is **%09+**.
- By default, there is no Control Operator Password defined.
- Master and Control Operator Passwords can be changed at any time.
- When enabled, the Macro-Only Password is always **%0D+** and will not be recognized unless executed from within a macro. By default, Macro-Only Password Decoding is disabled.
- Passwords can be 2, 4, or 6 digits long.
- Passwords can consist of any combination of the characters 0, 1, 2, 3, 4, 5, 6, 7, 8, 9, A, B, C, and D.
- The star (\*) and pound (#) characters may not be used in passwords.

---

**Note:** Choose your passwords early in the programming process. If you create macros containing a Master or Control Operator password and then change the password, you will have to reprogram the macros.

---

A **Root Number** always follows the password.

- The root number selects a task to perform.
- Root numbers cannot be changed.
- Root numbers are either 2 or 4 digits long.
- Root numbers consist of the numerals 0 through 9 only.

**Data Digits** usually follow the root number.

- Data digits provide additional information needed to perform the task.
- A very simple command may not require any data digits.
- In this manual, letters are often used to indicate the format of data digits. For example, **%x yy zzzz+** means you need to enter two data digits for the first item, three for the second, and four for the third.

An **Enter** character (DTMF %\*) marks the end of the command and is similar to the carriage return on a computer keyboard or the equals key on a calculator. Having an Enter character allows the controller to handle commands of various lengths. The controller stores characters until either it sees an Enter character or it times out. When the controller sees the Enter character, it assumes the command is complete and sends it to a queue for execution.

The DTMF star (%\*) is a dedicated Enter character.

There are three additional ways of simulating the Enter character when entering commands via DTMF:

- A loss of carrier can serve as an Enter character when entering DTMF commands via a receiver input. (The *End-of-Transmission Command Execution* feature must be enabled. See page 7-12.)
- Allowing the Interdigit Timer to expire can serve as an Enter character when entering DTMF commands. (The *Command Execution on DTMF Interdigit Timer* feature must be enabled. See page 7-10.) This is a special application of the Interdigit Timer, which is more often used to flush an incomplete command.
- Allowing users to enter only macro names of a fixed number of digits means no Enter character is needed. (The *4<sup>th</sup> Digit Command Execution* feature must be enabled. See page 7-14.) This is a special application because it restricts commands to macros only.

Note that the loss-of-carrier scheme won't work if another carrier holds up the input after you've released the PTT button. The %\* can serve as the Enter character in that case. Further, by using the %\* as the Enter character, you may enter a series of commands without releasing the PTT button. (You do not have to wait for the acknowledgment message before entering the next command.)

### Example Control Command

Here's an example of a control command:

```
99 63 0112 0 *
```

---

**Note:** We've put the characters into groups to make the examples easier to understand. The spaces between groups do not represent pauses.

---

- The password in this example is 99, the default Master Password. If this password doesn't match one of the programmed passwords, the command will be ignored.

- The root number is 63. Root 63 controls software switches, but the controller needs to know the switch number and the desired status.
- The next four data digits point to switch 0112.
- The last data digit, 0, tells the controller to turn the switch off.
- The Enter character, \*, marks the end of the command.

If we enter this command correctly, the controller will turn the switch OFF and respond with an acknowledgement message. If we make a mistake . by entering %2+ instead of %0+ for the last data digit, for example . the controller will not change the status of the switch and will send an *Error Message*. If we use an incorrect password or a non-existent root number, the controller will ignore the command and not send a response.

## Command Response Messages

### Acknowledgments

Most Control Commands respond in some way to tell you that they were accepted by the controller, or that you made a mistake in entering the command. The usual *Acknowledgment Message* is *OK* (sent in CW). If another response is more appropriate, a different acknowledgment will be sent instead of the OK.

When a mistake is made entering a command, an error message (error) is sent in CW. There are two commonly-used error messages:

- **? err 1** means you have made an error in the number of keystrokes entered for a particular command. If the command requires 5 keystrokes, for example, and you entered 6, the response will be an error 1.
- **? err 2** means you have made an error in the data presented for a particular command. If a timer, for example, has a range of 0 to 5.0 seconds, and you entered 6.0 seconds, the response will be an error 2.

*Command Response Messages* can be turned ON and OFF using the *Enable/Disable Command Response Messages* commands and others described beginning on page 7-35.

---

**Note:** When entering commands on the serial port, acknowledgement messages are more descriptive. See Chapter 8, Serial Commands, for information on entering commands on the serial port.

---

## Special Keys

Two keys, the star (\*) and pound (#), have dedicated uses (they're also known as the asterisk and the octothorpe). You cannot use these characters in a password or macro name, and you won't find them in root numbers or data digits.

### Enter (\*)

As discussed previously, the Enter (\*) character is used to end a command.

### Clear (#)

If you realize you've made a mistake while entering a command, you can press the Clear (#) key to erase it. The Clear key erases partially-entered commands and has no effect after the Enter character is received.

- You may begin the next command immediately after pressing the Clear (#) key.
- No acknowledgment or error message is sent when you clear a command.

## Valid DTMF Timing

DTMF characters must be at least 50 mS in duration and followed by a pause at least 50 mS in duration. That's a best-case transfer of 10 digits per second, assuming the audio is clean (not noisy). To send automatically-generated DTMF from a radio that stores DTMF strings or from a PC sound card or modem, configure your equipment for 50 mS minimum (and preferably longer) tone and pause durations.

## DTMF Interdigit Timer

The controller uses a *DTMF Interdigit Timer* for the purpose of clearing the command buffer if a command is not completely entered.

For example, if a user accidentally presses a digit, or if a digit is *falsed* into the buffer, or if a user drives out of range or his signal flutters while entering a command, the command buffer will have only a piece of a command. If the controller had no time limit between digits, that partial command would stay in the buffer. The controller would confuse it with the next command it receives.

The DTMF interdigit timer works as follows:

- When you release any DTMF key, the timer is started.
- If you do not enter another DTMF digit within the time limit, the controller will clear the command buffer.
- The interdigit timer initially defaults to 5.0 seconds, but it can be reprogrammed with a different value if desired as described on page 7-8.

Unkeying has the same effect as having the interdigit timer expire. This also clears the command buffer.

## DTMF Mute Delay

The controller has a *DTMF Mute* feature that prevents your DTMF commands from being repeated. This feature can be turned ON and OFF for various Receiver-Transmitter combinations using the *DTMF Decoder Mute* commands described beginning on page 7-19.

If you haven't configured your controller with an Audio Delay, there will be a short burst (40 to 50mS) of DTMF that is repeated at the beginning of a digit. This short burst occurs because the controller requires some time to detect the DTMF digit and shut OFF the audio gate.

To reduce the number of bursts, the controller will continue to mute the audio for a while after you have released the DTMF key. Therefore, if you enter a string of digits rapidly, there will be only a single burst (caused by the beginning of the first digit). If you wait too long between digits, the muting will end. The next digit you enter will cause a short burst at the beginning. The *DTMF Decoder Mute Delay* initially defaults to 0.5 seconds for all digits, but it can be reprogrammed with different value for the first digit and subsequent digits if desired.

## Switches

*Software Switches* are one of the basic *datatypes* used within the 7330 controller. Software switches store only two values:

- Set or ON or Enabled or %0+
- Cleared or OFF or Disabled or %1+

Software switches are used for a variety of configuration and control functions within the controller. User switches are defined for testing in macros.

### Software Switch Numbering

All *Software Switch* commands accept a *Software Switch Number*. The format of the *Software Switch Number* is:

*Opxx*

Where:

- *O* is always zero
- *p* is the Port number, 0 = general, not associated with a port, 1 = Port #1, 2 = Port #2, 3 = Port #3. Port can mean a DTMF decoder, a receiver, or a transmitter, depending the specific use.
- *xx* is a software switch number for that port.

For example, software switch 0153 has the following meaning:

- %0+. this digit is always zero
- %1+. this software switch is associated with the transmitter on port 1
- %53+. this is the specific software switch.

Looking this up in the *Software Switch Table* in *Appendix A*, you will see that this *Software Switch Number* defines the *Receiver #3-to-Transmitter #1 Path DTMF Mute Enable* described on page 7-20.

### Setting and Clearing Software Switches

All software switch commands use this format:

(PW) 63 (switch number) (value) \*.

The *Root Number* for all *Software Switch* commands is 63.

The *Switch Number* follows the *Root Number* and is always a four-digit number as described above.

The *Switch Value* is a single digit, either 0/OFF/Disabled/Cleared or 1/ON/Enabled/Set.

## Testing Software Switches

The If-Then-Else command (see page 5-21) tests the value of a switch using this command format:

(PW) 76 03 (switch number) (true macro) (false macro) \*.

The *Root Number* for If-Then-Else is 76.

The *Datatype* follows the *Root Number* and is always a two-digit number. For Software Switches, it is always 03.

The *Switch Number* follows the *Datatype* and is always a four-digit number as described above.

The *True Macro* and *False Macro* are each four-digit macro names. The *False Macro* is optional.

## Reading Software Switches

The Readback command (see page 3-20) speaks the value of a switch using this command format:

(PW) 37 03 (switch number) \*.

The *Root Number* for Readback is 37.

The *Datatype* follows the *Root Number* and is always a two-digit number. For Software Switches, it is always 03.

The *Switch Number* follows the *Datatype* and is always a four-digit number as described above.

---

**Note:** Details of each *Software Switch* are described in the command chapters. A *Software Switch Table* listing all software switches by number is located in *Appendix A*.

---



## Booleans

*Booleans* are one of the basic *datatypes* used within the 7330 controller. Booleans check and read back as only two values:

- Set or ON or Enabled or %~~0~~+ or Active
- Cleared or OFF or Disabled or %~~0~~+ or Inactive

Booleans make available signals inside the controller that can be used for testing or reading. When used with the If-Then-Else command (see page 5-21), macro execution can change based on the value of a boolean.

For Logic Inputs, COR, and CTCSS, %~~A~~Active+ is when the front panel LED is lit.

## Boolean Numbering

All *Boolean* commands accept a *Boolean Number*. The format of the *Boolean Number* is:

*Op~~0~~xx*

Where:

- *0* is always zero
- *p* is the Port number, 0 = general, not associated with a port, 1 = Port #1, 2 = Port #2, 3 = Port #3. Port can mean a DTMF decoder, a receiver, or a transmitter, depending the specific use.
- *xx* is a boolean number for that port.

For example, boolean 0106 has the following meaning:

- %~~0~~+ . this digit is always zero
- %~~1~~+ . this boolean is associated with port 1
- %~~06~~+ . this is the specific boolean.

Looking this up in the *Boolean Table* in *Appendix A*, you~~ll~~ see that this *Boolean Number* returns the *Receiver #1-to-Transmitter #1 Path Active* status.

## Testing Booleans

The If-Then-Else command (see page 5-21) tests the value of a boolean using this command format:

(PW) 76 04 (boolean number) (true macro) (false macro) \*.

The *Root Number* for If-Then-Else is 76.

The *Datatype* follows the *Root Number* and is always a two-digit number. For booleans, it is always 04.

The *Boolean Number* follows the *Datatype* and is always a four-digit number as described above.

The *True Macro* and *False Macro* are each four-digit macro names. The *False Macro* is optional.

## Reading Booleans

The Readback command (see page 3-20) speaks the value of a boolean using this command format:

(PW) 37 04 (boolean number) \*.

The *Root Number* for Readback is 37.

The *Datatype* follows the *Root Number* and is always a two-digit number. For Booleans, it is always 04.

The *Boolean Number* follows the *Datatype* and is always a four-digit number as described above.

## Counters

Counters are one of the basic *datatypes* used within the 7330 controller. Counters keep track of various resources in the controller and can have values of 0 thru 65535. In addition, for each counter, there is a *Counter Reload Value* that is used to define an action that should occur at that value.

### Counter Numbering

All Counter commands accept a Counter Number. The format of the Counter Number is:

*0pxx*

Where:

- *0* is always zero
- *p* is the Port number, 0 = general, not associated with a port, 1 = Port #1, 2 = Port #2, 3 = Port #3.
- *xx* is a counter number for that port.

For example, counter number 0302 has the following meaning:

- ~~0~~+. this digit is always zero
- ~~3~~+. this counter is associated with port 3
- ~~0~~2+. this is the specific counter.

Looking this up in the Counter Table in Appendix A, you will see that this Counter Number defines the Receiver #2-to-Transmitter #3 Path End-of-Activity Counter described on page 9-31.

### Selecting a Counter Reload Value

All counter reload commands have this format:

(PW) 45 (Counter Number) (Counter Reload Value) \*

The Counter Number identifies a specific counter. It is always a four-digit number as described above.

The Counter Reload Value is a one- to five-digit number in the range of 0 through 65535. Entering no value is the same as entering zero.

## Reading Counters

The Readback command (see page 3-20) speaks the value of a counter using this command format:

(PW) 37 07 (counter number) \*.

The *Root Number* for Readback is 37.

The *Datatype* follows the *Root Number* and is always a two-digit number. For counters, it is always 07.

The *Counter Number* follows the *Datatype* and is always a four-digit number as described above.

## Timers

Timers are one of the basic *datatypes* used within the 7330 controller. There are three types of timers in the 7330, grouped according to resolution:

- 0.01 seconds (10 milliseconds) for high resolution, short timing jobs;
- 0.1 seconds (100 milliseconds) for medium resolution, medium timing jobs; and
- 1 second for low resolution, long timing jobs.

### Timer Numbering

All Timer commands accept a Timer Number. The format of the Timer Number is:

*rpxx*

Where:

- *r* is the resolution digit, 0 = 10ms, 1 = 100ms, 2 = 1sec.
- *p* is the Port number, 0 = general, not associated with a port, 1 = Port #1, 2 = Port #2, 3 = Port #3.
- *xx* is a timer number for that port at that resolution, 00 thru 99.

Timer numbers beginning with 0 have increments of 0.01 seconds (10 milliseconds). They are for short jobs, like timing DTMF digits and Courtesy Delays. Their range is 0 to 65535 seconds (65535 counts x 0.01 seconds/count). That's a maximum of 10 minutes and 55.35 seconds.

Timer numbers beginning with 1 have increments of 0.1 seconds (100 milliseconds). They are for medium jobs, like the DTMF Long Tone Timer. Their range is 0 to 6553.5 seconds (65535 counts x 0.1 seconds/count). That's a maximum of 109 minutes and 13.5 seconds.

Timer numbers beginning with 2 have increments of 1 second (1000 milliseconds). They are for long jobs, like repeater timeout. Their range is 0 to 65535 seconds (65535 counts x 1 second/count). That's a maximum of 1,092 minutes and 15 seconds, or a little over 18 hours.

For example, timer 2306 has the following meaning:

- ~~2~~+. this is a timer with 1 second resolution
- ~~3~~+. this timer is associated with port 3
- ~~0~~6+. this is the specific timer.

Looking this up in the Timer Table in Appendix A, you will see that this Timer Number defines the Transmitter #3 Identifier Message Interval Timer described on page 12-3.

## Exceptions to Range

Since it's possible to create serious system problems by entering values that are too large or too small into certain timers, some Timers have upper and/or lower limits.

For example, you might accidentally enter a value of %10+ into a timer that has 10-mS increments, perhaps thinking it had 1-second increments. That would be much of a problem if it's a courtesy delay timer.

But if it's a DTMF Decoder Interdigit Timer (which sets the maximum allowable time between digits), then setting it to %10+ (only 10 milliseconds) would make it impossible for the DTMF decoder to work, so a higher minimum value is enforced by the controller for this specific timer.

For this reason, the timer command won't accept values above or below specific limits for some timers and will send an error message instead. If a timer has these limits, they will be indicated in the timer's description in the manual.

## Selecting a Time Value

All timer commands use this format:

(PW) 09 xxxx (time value) \*

where xxxx is a four-digit Timer Number as described above.

---

**Note:** Details of each Timer are described in the command chapters. A Timer Table listing all Timers by number is located in Appendix A.

---

Here's an example of a timer command to set a 0.01 second timer:

(PW) 09 0105 yyyyy \*

The Root Number for all timer commands is 09.

The Timer Number, 0105 in this example, follows the Root Number and is always a four-digit number.

The Time Value follows the Timer Number, yyyyy in this example, and indicates how many time increments we want. The Timer Command allows a variable number of Timer Value digits. One to five digits may be entered.

In this example, the timer has 0.01-second (10 millisecond) increments because the timer number begins with 0. Also, think of the last two digits of the time value being to the right of the decimal point.

We can figure out the number of increments we need by dividing the desired time value by the size of the increment. For example, if we want 2.5 seconds, we can divide 2.5 seconds by the increment (0.01 seconds) to get 250 increments. You can do the same thing by moving the decimal point two places to the right. The command would be:

```
(PW) 09 0105 250 *
```

Timer commands do not accept a decimal point+character when entered.

## Event-Triggered Macros

*Event-Triggered Macros* (EVMs also called *Event Macros*) are one of the basic *datatypes* used within the 7330 controller. Event-Triggered Macros store a Macro Name (see Chapter 5) to be executed when a specific action occurs within the controller.

### Event-Triggered Macro Numbering

All Event-Triggered Macro commands accept an Event-Triggered Macro Number. The format of the Event-Triggered Macro Number is:

*Opxx*

Where:

- *O* is always zero
- *p* is the Port number, 0 = general, not associated with a port, 1 = Port #1, 2 = Port #2, 3 = Port #3.
- *xx* is an event-triggered macro number for that port.

For example, event-triggered macro number 0231 has the following meaning:

- ~~0~~<sub>+</sub>. this digit is always zero
- ~~2~~<sub>+</sub>. this counter is associated with port 2
- ~~3~~<sub>1+</sub>. this is the specific event-triggered macro.

Looking this up in the Event-Triggered Macro Table in Appendix A, you will see that this event-triggered macro number defines the Timeout Macro to be executed when path Receiver #2-to-Transmitter #1 times out (see page 9-23).



## Selecting an Event-Triggered Macro Value

All event-triggered macro commands have this format:

(PW) 26 (event-triggered macro number) (macro name) \*

The Event-Triggered Macro Number identifies a specific event-triggered macro. It is always a four-digit number as described above.

## Reading Counters

The Readback command (see page 3-20) speaks the value of an event-triggered macro using this command format:

(PW) 37 08 (event-triggered macro number) \*.

The *Root Number* for Readback is 37.

The *Datatype* follows the *Root Number* and is always a two-digit number. For event-triggered macros, it is always 08.

The *Event-Triggered Macro Number* follows the *Datatype* value and is always a four-digit number as described above.

## Readback

Speaks the setting and current value of a datatype.

- Speaks a message back to the port the command was entered on.
- If the command was entered on the serial console, speaks on port 1.
- Enter password, the 2-digit root number, the 2-digit datatype, the 4-digit datatype number.

### Command Form:

Command	Form	Data Digit
Readback Timers, Software Switches, Booleans, Counters, Event-Triggered Macros	(PW) 37 ww rpil *	ww = datatype number (see table below) rpil = datatype to read
Readback Path (RX to Dtmf)	(PW) 37 ww x *	ww = datatype number (see table below) x = path 1, 2, or 3
Readback Setpoints, User Timers, Path (RX to TX), Analog Input Unscaled	(PW) 37 ww xx *	ww = datatype number (see table below) xx = datatype to test
Readback	(PW) 37 ww xxmm *	ww = datatype number (see table below) xx = datatype to test for Analog Inputs mm = meter face number, 00 = unscaled

### Value Types:

Type Number	Type Name	Value To Test
00	Timers	Timer Number. (See page 3-15 and the timer command and summary table starting on page A-41.)
03	Software Switch	Software Switch Number. (See page 3-9 and the software switch command and summary table starting on page A-46.)
04	Boolean	Boolean Number. (See page 3-11 and the summary table starting on page A-50.)
05	Scheduler Setpoint	Scheduler Setpoint Number. (See page 22-3.)
06	User Timers	User Timer Number (See page 20-1.)
07	Counter	Counter Number (See page 3-13 and the summary table starting on page A-49.)
08	Event-Triggered Macro	Event-Triggered Macro (See pages 3-18 and the summary table starting on page A-36.)
09	Path	Path Number (See page 3-2 and the summary table on page A-45.)
10	Analog Input (A2D)	Analog Input Number (See page 16-2.)

**Acknowledgment:** Speaks information about the selected datatype.

**Errors:**

<b>Error</b>	<b>Meaning</b>
? err 1	wrong number of digits entered
? err 2	illegal digit entered

**Default Condition:** N/A

**Example #1, Datatype 00, Read the value of a timer:**

To read the setting and value of the Transmitter #1 PTT Minimum Unkey Delay timer, enter:

(PW) 37 00 0102 \*

**Example #2, Datatype 03, Read the value of a software switch:**

To read the value of the Path 12 Enable software switch, enter:

(PW) 37 03 0241 \*

**Example #3, Datatype 04, Read the value of a boolean:**

To read the value of Logic Input #1, enter:

(PW) 37 04 0013 \*

**Example #4, Datatype 05, Read the setting of a scheduler setpoint:**

To read the current setting of Scheduler Setpoint 12, enter:

(PW) 37 05 12 \*

**Example #5, Datatype 06, Read the setting and value of a user timer:**

To read the current setting and value of User Timer 9, enter:

(PW) 37 06 09 \*

**Example #6, Datatype 07, Read the value of a counter:**

To read the current setting and value of Counter 0100, enter:

(PW) 37 07 0100 \*

**Example #7, Datatype 08, Read the value of an event-triggered macro:**

To read the current setting of the Logic Input #1 Hi-to-Lo Event-Triggered Macro, Event-Triggered Maco number 0061, enter:

(PW) 37 08 0061 \*

**Example #8, Datatype 09, Read the current path access mode for a path to a DTMF decoder:**

To read the current path access mode for RX1 to DTMF, enter:

(PW) 37 09 1 \*

**Example #9, Datatype 09, Read the current path access mode for a path from one port to another:**

To read the current path access mode for RX1 to TX2, enter:

(PW) 37 09 12 \*

**Example #10, Datatype 10, Read the current value of an analog input:**

To read the current unscaled value of analog input #3, enter:

(PW) 37 10 03 00 \*

To read the current unscaled value of analog input #3 (the unscaled format is the default), enter:

(PW) 37 10 03 \*

To read the current value of analog input #3 using meter face #7, enter:

(PW) 37 10 03 07 \*

---

## Chapter 4

# Security

---

One of the *Security* features used by the computer is a dual-password system. There are two levels of command privileges.

- The operators holding the *Master Password* are the higher level group, since the master password may be used with all control commands.
- The operators holding the *Control Operator Password* are the lower level group, since their password only works with certain owner-designated control commands.

You may select the commands that are available to the control operators, which range from none to all commands.

- The master password and the control operator password may be 2, 4, or 6 digits long.
- The passwords may contain the numbers 0-9, and the lettered keys A, B, C, and D.

There are several features that you can use to improve the security of the controller. You can hide DTMF tones on the output of the repeater by enabling DTMF Mute (see page 7-19) and the DTMF Cover Tone (see page 7-24). You can limit all commands on a radio port to 4 digits long (see page 7-14).

To enhance security at your site, you can disable the LEDs on the *Front Panel Display*. Disabling the *Front Panel Display* prevents display of all LEDs on the front panel except the power LED. The Power LED is always on when power is applied to the controller.

---

---

## Assign Master Password

**Assigns a new master password.**

- The new *Master Password* may be 2, 4, or 6 digits in length.
  - The new *Master Password* may be any combination of the numbers 0-9 and the letters A-D.
- 
- 

### Command Form:

Command	Form
Assign Master Password	(PW) 93 (new master password) *

**Acknowledgment:** Sends *OK* message

### Errors:

Error	Meaning
? err 1	wrong number of digits entered

**Default Condition:** *Master Password* defaults to 99

### Examples:

Assume that the present master password is 99, the default password. To change it to 1234, enter this:

```
99 93 1234 *
```

The new password is 1234 at this time. To change it to 2A3B4C, enter this:

```
1234 93 2A3B4C *
```

---



---

## Assign Control Operator Password

**Assigns a new password for control operators.**

- The new *Control Operator Password* may be 2, 4, or 6 digits in length.
  - The new *Control Operator Password* may be any combination of the numbers 0-9 and the letters A-D.
- 
- 

### Command Form:

Command	Form
Assign Control Operator Password	(PW) 92 (new control operator password) *

**Acknowledgment:** Sends *OK* message

### Errors:

Error	Meaning
? err 1	wrong number of digits entered

**Default Condition:** No *Control Operator Password* is assigned

### Examples:

Assume there is no control operator password, the default condition. To assign it to 95, enter this:

```
(PW) 92 95 *
```

"(PW)" must be the master password, since no control operator password exists.

If the master password is 2A3B4C, enter this:

```
2A3B4C 92 95 *
```

---



---

## Assign Control Operator Privilege Level

Limits access of control operators to the repeater functions by assigning privilege levels to control commands.

- Enter the root number of the command for which a privilege level change is desired, then enter a 0 or 1 for the privilege level. See the root number table at page A-34.
  - 0 = control command may be used by *either* the master or the control operator password.
  - 1 = control command may be used *only* by the master password.
- 
- 

### Command Form:

Command	Form	Data Digit
Assign Control Operator Privilege Level	(PW) 94 (command root number) x*	0 = used by either password 1 = used by only master password

**Acknowledgment:** Sends *OK* message

### Errors:

Error	Meaning
? err 1	wrong number of digits entered
? err 2	illegal digit entered

**Default Condition:** All commands may be used by either password.

### Example:

Assume the control operators have full privileges, the default condition. To prevent control operators from changing either the master password or the control operator password, enter this:

```
(PW) 94 92 1 *
```

```
(PW) 94 93 1 *
```

Root 92 is the *Assign Control Operator Password* command on page 4-3.  
Root 93 is the *Assign Master Password* command on page 4-2.

---

**Note:** If you want to prevent a control operator from accessing more than one root code in a row, use the *Assign Control Operator Privilege Level to a Range of Commands* command (see page 4-5.)

---



---



---

## Assign Control Operator Privilege Level to a Range of Commands

**Changes the Control Operator Privilege on a range of commands.**

- Enter the first and last root number of the command for which a privilege level change is desired, then enter a 0 or 1 for the privilege level. See the root number table at page A-34.
  - 0 = control command may be used by *either* the master or the control operator password.
  - 1 = control command may be used *only* by the master password.
- 
- 

### Command Form:

Command	Form	Data Digit
Assign Control Operator Privilege Level to a Range of Commands	(PW) 94 (first root number) (last root number) x*	0 = used by either password 1 = used by only master password

**Acknowledgment:** Sends *OK* message

### Errors:

Error	Meaning
? err 1	wrong number of digits entered
? err 2	illegal digit entered

**Default Condition:** All commands may be used by either password.

### Example:

Assume that you want to reset all privilege level entries for use by both passwords, enter the following:

```
(PW) 94 00 99 0 *
```

Assume that you want to prevent control operators from changing passwords or a privilege level enter the following:

```
(PW) 94 92 94 1 *
```

---

**Note:** If you want to prevent a control operator from accessing a single root code use the *Assign Control Operator Privilege Level* command (see page 4-4.)

---

---

---

## Enable/Disable Front Panel Display

### Controls the Front Panel Display.

- By default the Front Panel Display is enabled.
  - The Front Panel Display may be disabled to improve site security.
  - Enter the password, the 2-digit root number, the 4-digit software switch number, and one digit, 0 for OFF (disabled), 1 for ON (enabled).
  - The Green Power LED is unaffected by this command as it is always on when the controller has power.
- 
- 

### Command Form:

Command	Form	Data Digit
Enable/Disable Front Panel Display	(PW) 63 0000 x *	0 = OFF (disabled) 1 = ON (enabled)

**Acknowledgment:** Sends *OK* message

### Errors:

Error	Meaning
? err 1	wrong number of digits entered
? err 2	illegal digit entered

**Default Condition:** the Front Panel Display is enabled.

---

## Chapter 5

# Macros

---

One of the most powerful features of your controller is its ability to store and recall multiple groups of commands stored in controller memory under unique names. Each group of commands is called a *Macro*. The name of each macro, and its contents, are fully programmable. Each macro can be up to 200 digits long (and if that's not enough you can chain multiple macros). The macro name can be 1, 2, 3, or 4 digits, and can be any DTMF digit except (\*) and (#).

The initial condition of the controller as shipped, and after a cold start, is empty; no macros exist until you create them using the built-in commands. If you want to, you can delete all macros and start over. All of the programming can be prepared offline in a simple text editor and uploaded.

There are many advantages in using macros instead of the full programming commands, including:

- **Time Savings.** Often-used or long commands can be stored in macros, then executed by entering just the *Macro Names*.
- **Fewer Errors.** There is a much smaller likelihood of making an error when entering a short macro name instead of a long series of digits.
- **Better Security.** Create a library of macros for your users and restrict the actual programming passwords to yourself and a few control operators. If a macro becomes abused, rename or delete it.
- **Better Control.** Your controller can execute macros from DTMF commands on a receiver, from commands on a serial port, from logic inputs, from Scheduler commands, or from system events, giving you more control over your system.

## Quantity of Macros

Your controller supports a total of 340 macros. If you use, for example, 220 macros for scheduled announcements and remote base commands, you will still have 120 macros available for your user library.

## Size of Macros

Each macro may contain a maximum of 200 digits (keystrokes). Therefore, a macro may contain a single command of 200 digits, or more commands of fewer digits. The macro loses two digits each time you store (append) an additional command, and it loses one more if the appended command has an odd number of digits. Thus, a macro can contain a single command of 200 digits, or two commands totalling 198 digits, or three commands totalling 196, and so forth.

If the amount of memory remaining in a macro is insufficient to store a desired command, there may still be enough room to store the name of another macro. Chaining another macro to the original macro expands the storage capacity by another 200 digits.

---

**Note:** Commands must reside completely within a macro. You may not store part of a command in one macro and continue it in another macro.

---

## Names of Macros

You name the macro when you create it. Creating a macro causes the controller to put the macro name in a directory so it can find the macro at execution time. A macro can be renamed, since the controller can easily replace the old macro name in the directory with a new one. A macro can be deleted, since the controller can erase the name in the directory.

You can give a macro any name that is 1, 2, 3, or 4 characters in length and does not contain a (\*) or (#). Thus, you may use the characters 0 through 9 and the lettered keys (A, B, C, and D). Names you could use included %0, %1, %2, %3, %4, %5, %6, %7, %8, %9, %A, %B, %C, %D, and so on. Some users only have 12-button keypads. When programming macros that will be used by those users, you may want to avoid using the lettered keys (A, B, C, and D).

If the *Macro Name* has leading zeros, they will be ignored by the controller when executing a macro. For example, the following macro names will all refer to the same macro: 5, 05, 005, 0005. You may execute the macro by entering any of these names. When you chain a macro to another macro, you may enter the macro name into the original macro by skipping the leading zeros.

---

**Note:** When you are creating or modifying a macro, you will have to enter all 4 digits, because the 4 digits act as placeholders in commands and the macro directory. You must use leading zeros if necessary, since skipping them will cause the command to have the wrong format and generate an error message. Therefore, when creating a new macro, or using any of the other commands that specify a 4-digit macro name, enter leading zeros if the name has fewer than 4 digits. The manual page for each command is very specific about this.

---

## Contents of Macros

You may store any sequence of digits into a macro except for the (\*) and (#). The (\*) is entered last, to terminate the command and indicate the end of the data to be stored. Since the (\*) and (#) cannot occur in the data being stored, you must store one command at a time. Store the first command in a macro when you create it using the *Create New Macro* command on page 5-9, and store any additional commands using the *Append To Macro* command on page 5-11.

A macro, then, can store programming commands, other macro names, or both. You can create *Master Macros* which contain the names of other macros, and by simply entering the name of the master macro, you will cause all of them to be executed.

## Sequence of Execution Within A Macro

When a macro is executed, the commands (or other macro names) stored in that macro are executed in the order they were stored. For example, assume that a certain macro contains a programming command, a macro name, and another programming command like this:

```
command1
macro2
command2
```

And the second macro contains two commands like this:

```
command21
command22
```

When this macro is executed, the first programming command will be executed. Then, the embedded macro will be fully executed. (This means that if the embedded macro contains other commands and other macros, they will all be executed before the remaining items in the embedded macro are executed.) Finally, the last programming command in the first macro will be executed. The sequence looks like this:

```
command1
command21
command22
command2
```

Your controller has the ability to queue up to 50 commands or macros at one time for each DTMF decoder and the serial port. In addition, up to 50 commands or macros can be queued by Event-Triggered Macros.

## Changing The Sequence: If/Then/Else

Macros can adjust their own execution sequence based on the values of timers and counters and the current state of software switches and booleans. This allows the sequence of commands in a macro to adapt to the current operation of the repeater.

For example, assume that you have defined a macro that contains a programming command, an If/Then/Else command and two more programming commands like this:

```
command1
ifCommand (trueMacro, falseMacro)
command2
command3
```

another macro (the `trueMacro` in this example) that is executed when the If/Then/Else test returns `true`:

```
command21
command22
```

and another macro (the `falseMacro` in this example) that is executed when the If/Then/Else test returns `false`:

```
command31
command32
```

When the first macro is executed and the `ifCommand` test returns `true`, the `trueMacro` is expanded and the overall set of commands are executed in this order:

```
command1
command21
command22
command2
command3
```

When the `ifCommand` test returns `false`, the `falseMacro` is expanded and the overall set of the commands will be executed in this order:

```
command1
command31
command32
command2
command3
```

---

**Note:** The `falseMacro` in the If/Then/Else command is optional.

---

## Passwords In Macros

On page 3-4, we defined the passwords available in the controller. You can use any of these passwords in a macro when adding programming commands. There are some things to consider when choosing which passwords to use:

- A macro created containing a command that uses a Master Password will work properly as long as the Master Password is not changed. If you change the password, the macro will no longer work.
- A macro created containing a command that uses a Control Operator Password will work as long as the Control Operator Password is defined and is not changed. If you change the password, the macro will no longer work.
- A macro created containing a command that uses the Macro-Only Password (always DD) will always work as long as Macro-Only Password Decoding is enabled (see page 5-8).

## Cautions

### Macro Loops

*Do not* create a *loop* by creating a macro that calls its own name. Likewise, do not create a series of macros that will eventually loop back and call the originating macro. For example, don't create a macro named 65, which calls macro 66, which calls macro 67, which calls 65. The result will be a locked up command executive associated with that DTMF decoder or serial port that will require you to delete the offending macros from another input or enter 50 commands on the locked up input. On the 51<sup>st</sup> command, the buffer is cleared.

---

**Note:** The controller does not check the validity of the data stored in macros; it simply stores whatever data you specify. If you create errors in the data you store in macros, or if you change a command password after commands using the password are stored in macros, the macros will not execute properly.

---

### Macro Name and Password Conflicts

When DTMF digits are entered and the command executive is comparing the digits to passwords and macro names, the passwords will be checked first. This means that if the Master or Control Operator Password is 99, then any macro name that starts with 99 will not be recognized as a macro. The command executive will try to execute that name as a command.

The same is true when Macro-Only Password Decoding is enabled. Any macro name that starts with DD will not be recognized as a macro. The command executive will try to execute that name as a command.

## Macro Execution: DTMF Entry

Each receiver has its own DTMF decoder and command processor. Users can enter commands on all receivers simultaneously. Macro names and commands entered by users are executed by a command executive that is dedicated to its DTMF decoder.

You can execute commands and macros in four ways:

- Enter the command or macro name followed by the (\*).
- You can skip the (\*) if you have turned ON the command-execution-on-carrier-drop feature using the *End-of-Transmission Command Execution* commands (page 7-12).
- Enter the command digits, then wait the Interdigit Time if you have turned ON the *Enable/Disable Command Execution on Interdigit Timer* feature. **Special applications only!**
- Enter only macro names of the correct number of digits if you have turned ON the *Enable/Disable Command Execution on 4<sup>th</sup> Digit* feature. **Special applications only!**

---

**Note, difference from previous S-COM Controllers:** Previous *S-COM Controllers* had only a single DTMF decoder and implemented a priority scheme for selecting which source owned the DTMF decoder. In the *S-COM 7330 Controller*, the DTMF selection scheme has been eliminated. All receivers have dedicated DTMF decoders and command processors.

---

Audio responses from commands and macros executed from a DTMF entry are returned to the port they are entered on except for messages containing *Message Routing Control Characters* (see page 6-4).

## Macro Execution: Serial Port

Macro names and commands entered on the serial port (referred to as the *Console Serial Port* later in the manual) are executed by a command executive that is dedicated to that serial port. You can enter commands on the serial port simultaneously with users entering commands via the receivers' DTMF decoders.

You can execute commands and macros by entering the command or macro name followed by the (\*). All audio responses from the commands and macros, i.e. beeps, CW, speech, are transmitted on port 1. See chapter 8, *Serial Commands*, for more information on using the serial port.



## Macro Execution: Event-Triggered Macros

You can configure the controller to automatically execute macros based on hardware or firmware state changes. There are many of these *Event-Triggered Macros* described throughout the manual. (See page A-36 for the full list.)

Here are some examples of Event-Triggered Macros:

- Execute a macro when the controller restarts after a power failure (Power ON-Triggered Macro).
- Execute a macro when a Logic Input changes state from Low to High or from High to Low.
- Execute a macro on receipt of a LiTZ DTMF digit (DTMF Long Tone Macros).
- Execute a macro after the repeater hasn't been in use for a programmed amount of time, like 5 minutes (Activity Timer/Counter/Macro).
- Execute a macro from a scheduler event

Event-Triggered Macros are executed by the command executive that is dedicated to Event-Triggered Macros. This way, they won't delay the execution of any macros entered via DTMF by users or on the serial port.

## Applications of Macros

Since macros can store any commands, you can create macros which change the personality of the repeater. An *Emergency Status Macro* might change the ID and tail messages; a *Normal Status Macro* could change these parameters back to the usual settings.

A macro can be created to announce the beginning of a net by sending a tone page and a speech message. Enter another macro to announce the club meeting as part of the ID message a week before the meeting occurs. (Entering long strings of digits are unnecessary each time you want to use them if you program them into macros beforehand.)

A library of macros can be created to serve your club members. Some quick examples might include:

- Send the time or date.
- Generate DTMF pages to activate selective call decoders (and the handholds that have built-in DTMF decoders).
- Reset the repeater timeout timer.
- Pulse a tape cartridge machine that plays the latest club announcements.
- Switch between normal and net mode. (Net mode might relax the timeout timer and change the ID message.)

---



---

## Enable/Disable Macro-Only Password Decoding

Controls the decoding of the controller's Macro-Only Password, %DD+.

- When enabled, the Macro-Only Password will be recognized when used in a command inside a macro.
- When disabled, the command executive will not check commands in a macro for a Macro-Only Password.
- Enter the password, the 2-digit root number, the 4-digit software switch number, and one digit, 0 for OFF (disabled), 1 for ON (enabled).

---



---

### Command Form:

Command	Form	Data Digit
Enable/Disable Macro-Only Password Decoding	(PW) 63 0004 x *	0 = OFF (disabled) 1 = ON (enabled)

**Acknowledgment:** Sends *OK* message

### Errors:

Error	Meaning
? err 1	wrong number of digits entered
? err 2	Illegal digit entered

**Default:** disabled (OFF). The command executive will not check for the Macro-Only Password in the commands of a macro.

### Examples:

Macros normally contain only the names of other macros and commands that start with a predefined Master Password or Control Operator Password. To use the Macro-Only Password in commands contained within macros, set this software switch:

```
(PW) 63 0004 1 *
```

The Macro-Only Password, DD, can only be used as the password of a command being inserted into a macro. In the following example, a macro named 123 is being created. The first command in the macro is

```
(PW) 63 0001 1:
```

```
(PW) 20 0123 DD 63 0001 1 *
```

---

**Note:** Since commands in macros that use the Macro-Only Password (DD) are always executed, security schemes that depend on a specific Control Operator Password must use the expected password instead of DD.

---

---



---

## Create New Macro

Places the name of the new macro in the directory, then places the digits following the macro name into a storage area in memory.

- A new macro is a macro with a name that is not presently in the macro directory.
- The digits that are stored in memory are shown below as *Command*, in the command form section. Command may be either a control command, or the name of another macro.
- If you are storing a control command, do not forget to include the control command's password. In other words, the *command* stored into a macro must be a complete, executable command or macro.
- Enter the password, the 2-digit root number, the 4-digit macro name, and a complete controller command. Add leading zeros to the macro name, if required.

---



---

### Command Form:

Command	Form
Create New Macro	(PW) 20 (macro name, command) *

**Acknowledgment:** Sends OK message

### Errors:

Error	Meaning
? err 1	too few digits entered
? name used	macro name already exists in the directory
? dir full	directory is filled with the maximum number of macros
? too big	the command being entered for storage exceeds the storage area allowed for a macro

### Example:

Assume we wish to create a macro that turns on Logic Output #1. The control command would be:

```
(PW) 70 01 *
```

Since we do not wish to disclose the password to our users, we can simply place this command into a macro. Let's name the macro 6A (assume our users have 16-button DTMF keyboards that contain DTMF digits A, B, C, and D). Enter the following Create New Macro command to create the macro that contains the Select Logic Output command to turn on the logic output:

```
(PW) 20 006A (PW) 70 01 *
```

If additional commands are to be executed by entering the macro name 6A, they can be appended. (See the *Append to Macro* command on page 5-11.) Let's say that the repeater has a weather receiver connected to it, and that Logic Output #1 is connected to a relay that resets that receiver (the relay contacts are wired across the front panel reset button).

An additional command that you might want to include in macro 6A is an announcement that the weather receiver has been reset. In this case, the second command in the macro might be a command to speak a message with a leading one second pause and saying "Weather Receiver Reset". You append this command to the already created macro like this:

```
(PW) 29 006A (PW) 15 999310 9960 0377 0339 1293 *
```

A third command could be a pause that holds the logic output on for a short time (50 milliseconds in this case):

```
(PW) 29 006A (PW) 98 0 5 *
```

and the fourth and last command is to turn Logic Output #1 back off (since we want this logic output to function as a momentary reset pulse).

```
(PW) 29 006A (PW) 71 01 *
```

To execute this command, a user would enter:

```
6A *
```

---

**Notes:** The macro name is entered with leading zeroes, since the name chosen is less than 4 digits long. Also, the command following the macro name is a complete command, including password. You can use the Master Password, the Control Operator Password, or the Macro-Only Password, if enabled and this command is being used within a macro.

The acknowledgment message *OK* simply indicates that the *Create New Macro* command or the *Append to Macro* command was entered correctly, and that the controller created a new directory entry with some digits stored in memory. It does not guarantee that the digits it stored represented an executable command. It is possible to store garbage digits in a macro just as easily as legitimate commands.

---

---



---

## Append To Macro

This command is used to attach additional commands to a macro.

- The stored information, shown below as *Command*, in the command form section, may be a control command or another macro name (if you wish to chain together several macros or call a macro as a subroutine).
- The macro name of the macro that you are appending the command or macro name to must already exist in the directory.
- Macro names shorter than 4 digits must have leading zeros added so that the name is exactly 4 digits.
- Enter the password, the 2-digit root number, the 4-digit macro name, and a complete controller command. Add leading zeros to the macro name, if required.

---



---

### Command Form:

Command	Form
Append to Macro	(PW) 29 (macro name, command)*

**Acknowledgment:** Sends *OK* message

### Errors:

Error	Meaning
? err 1	too few digits entered
? not found	macro name does not exist in directory
? too big	command being entered exceeds the storage area remaining for this macro

**Default:** None

### Examples:

Assume that a macro has been created to turn ON Logic Output #1, and that its name is 6A. We wish to append a command that sends DTMF digits. This way, entering 6A will result in the controller both turning on the output and sending DTMF digits, in that order.

The command to append this next command to the macro is:

```
(PW) 29 006A (PW) 15 9950 01 02 03 *
```

---

**Note:** The macro 6A must already exist before this additional command may be appended. See the *Create New Macro* command on page 5-9.

---

The command to create this macro shown on page 5-11 would be followed by the command to append to the macro like this:

```
(PW) 20 006A (PW) 70 01 *
(PW) 29 006A (PW) 15 9950 01 02 03 *
```

If software switch *Macro-Only Password Decoding* is enabled (see page 5-8), these two commands would look like this:

```
(PW) 20 006A DD 70 01 *
(PW) 29 006A DD 15 9950 01 02 03 *
```

If a macro named 1234 is to be appended to macro 6A, the command would look like:

```
(PW) 29 006A 1234 *
```

Additional commands may be appended to the macro until the storage space for that macro is used up.

- If more commands are needed than can fit into a single macro, simply have the last command in the original macro be the name of another macro. The command executive will execute the first macro, command by command, then seamlessly execute the second macro command by command.
- This new macro is created and appended similarly to the original macro.
- If the new macro is filled, append another.
- This process can continue until the limit of 50 chained commands is reached.

To execute this macro, a user would enter:

```
6A *
```

---

**Note:** The acknowledgment message *OK* simply indicates that the *Append To Macro* command was entered correctly, and that the controller appended whatever digits were given after the macro name. It does not guarantee that the digits it stored represented an executable command. It is possible to store %garbage+digits in a macro just as easily as legitimate commands.

---

## Remove Last Command From Macro

Remove the last command from an existing macro.

- Removing the last command from the macro frees up that space in the macro.
- If there is only one command in the macro, the command will not be removed. Use the *Erase Macro* command in this case and recreate the macro.
- Enter the password, the 2-digit root number and the 4-digit macro name. Add leading zeros to the macro name, if required.

### Command Form:

Command	Form
Remove Last Command From Macro	(PW) 24 (macro name) *

**Acknowledgment:** Sends *OK* message

### Errors:

Error	Meaning
? err 1	wrong number of digits entered
? not found	macro name does not exist in the directory
? last	There is only one command in the macro

**Default:** None

### Examples:

Assume that a macro exists under the macro name 6A, and that it contains several commands. To remove the last command from the end of this macro, enter:

```
(PW) 24 006A *
```

After the above command is entered, the macro storage area used by the last command is freed and available for another command to be appended to the macro.

---

---

## List Macro

Examines the contents of a macro and sends it in either CW or speech.

- Entering one of these commands causes the controller to send all stored digits in CW or speech. In CW the (\*) character is sent as a fraction bar (/); in speech, the (\*) character is sent as the word %star+.
  - The macro name must be entered using 4 digits.
  - If the macro you wish to list has a shorter name, enter leading zeros.
  - Enter the password, the 2-digit root number and the 4-digit macro name. Add leading zeros to the macro name, if required.
- 
- 

### Command Form:

Command	Form
List Macro in CW	(PW) 33 (macro name) *
List Macro in Speech	(PW) 35 (macro name) *

**Acknowledgment:** Sends the contents of the macro in CW or speech.

### Errors:

Error	Meaning
? err 1	wrong number of digits entered
? not found	macro name does not exist in the directory

**Default Condition:** None.



**Example:**

Assume that a macro exists with the name 6A. It contains two commands as discussed in the *Create New Macro* and *Append To Macro* commands (see pages 5-9 and 5-11). To make the example clearer, assume that the password is 99.

When the commands were originally placed into the macro, they looked like this:

```
(PW) 70 01 * and 10 663 6000 *
```

To examine this macro in CW, we would enter:

```
(PW) 33 006A *
```

The controller would then send:

```
9 9 7 0 01 / 1 0 6 6 3 6 0 0 0 /
```

To examine this macro in speech, we would enter:

```
(PW) 35 006A *
```

The controller would then speak:

```
%Nine nine seven zero zero one star one zero six six three six zero zero  
zero star+
```

---

---

## Erase Macro

Erases an existing macro.

- Enter the password, the 2-digit root number and the 4-digit macro name. Add leading zeros to the macro name, if required.
  - If you wish to erase all macros, see the *Erase All Macros* command on page 5-18.
- 
- 

### Command Form:

Command	Form
Erase Macro	(PW) 21 (macro name) *

**Acknowledgment:** Sends *OK* message

### Errors:

Error	Meaning
? err 1	wrong number of digits entered
? err 2	macro name does not exist in the directory

**Default:** None

### Examples:

Assume that a macro exists under the macro name 6A, and that it contains several commands. To erase this macro, enter:

```
(PW) 21 006A *
```

After the above command is entered, macro 6A will no longer exist. The storage area used by this macro will be released, and another macro can be created to take its place. Macro name 6A, since it is now erased from the directory, can be used as the name of a new macro.

## Enable/Disable Erase Macro Command Returns OK

Controls the message returned when the specified macro name is not found in the macro directory.

- When enabled, returns *OK* instead *?err2* from the Erase Macro command.
- Enter the password, the 2-digit root number, the 4-digit software switch number, and one digit, 0 for OFF (disabled), 1 for ON (enabled).

### Command Form:

Command	Form	Data Digit
Enable/Disable Erase Macro Command Returns OK	(PW) 63 0003 x *	0 = OFF (disabled) 1 = ON (enabled)

**Acknowledgment:** Sends *OK* message

### Errors:

Error	Meaning
? err 1	wrong number of digits entered
? err 2	Illegal digit entered

**Default:** the Erase Macro command will return an *? err 2* when the specified macro name is not found

### Examples:

When sending commands to the controller by DTMF or through the serial port, you must erase a macro before an updated macro can be programmed into the controller. To make sure that commands are programmed properly, you should be checking for error messages returned from each command.

Many controller owners use a serial port to load their programming. As the programming is loaded, each comand causes an OK message and the programming continues.To ensure that there is no conflict the programming command file can have an erase macro command ahead of any new macro create command.

If you have Cold Started your controller, no macros will be programmed, so each time you erase a nonexistent macro, you will receive an error message (*? err 2*) even though in this case it is expected. By setting this software switch, you will receive an OK message instead of an error message and your programming can continue normally.

---

---

## Erase All Macros

Erases all existing macros. **\*\*\*\*\* USE WITH CARE \*\*\***

- If accidentally entered, all macros will be lost. There is no recovery.
  - The zeroes in the command must be entered as a precaution to avoid accidents.
  - If you wish to erase one or more selected macros, see the *Erase Macro* command on page 5-16.
  - Enter the password, the 2-digit root number and the digits %00+.
- 
- 

### Command Form:

Command	Form
Erase All Macros	(PW) 22 00 *

**Acknowledgment:** Sends *OK* message

### Errors:

Error	Meaning
? err 1	wrong number of digits entered
? err 2	zeroes were not entered

**Default:** None

## Rename Macro

Changes the name of an existing macro.

- The digits (contents) stored under the macro's name are not affected.
- Enter the password, the 2-digit root number and the 4-digit old macro name and the 4-digit new macro name. Add leading zeros to the macro name, if required.

### Command Form:

Command	Form
Rename Macro	(PW) 27 (old name, new name) *

**Acknowledgment:** Sends *OK* message

### Errors:

Error	Meaning
? err 1	wrong number of digits entered
? not found	old name does not exist in the directory
? name used	new name already exists in the directory

**Default:** None

**Examples:**

Assume that a macro exists under the name 6A, and that we wish to change its name to 1000. Enter the following command:

```
(PW) 27 006A 1000 *
```

---

**Note:** A macro name cannot conflict with a password. For example, a macro name of 1000 would cause a conflict if the control operator password were set to a value of 10. Be sure to select your macro names and passwords carefully.

---

Assume that we now wish to change its name to 789. Enter the following command:

```
(PW) 27 1000 0789 *
```

Finally, let's change its name once more to simply D. Enter the following command:

```
(PW) 27 0789 000D *
```

Here is a wrap-up of what we have done.

- Before its name was changed, the macro was executed by entering 6A\*.
- After the first name change, it was executed by entering 1000\*.
- After the second name change, it was executed by entering 789\*.
- After the third name change, it was executed by entering D\*.
- At no time did the contents of the macro change, just the name.

You can see that a macro can have a short or long name, and its name can be made up of numerals or letters (A, B, C, or D).

## If-Then-Else

Causes the controller to test a value to decide what macro to execute next.

- Executes a True Macro if the value is On, Nonzero, or True.
- Optionally executes a False Macro if the value is Off, Zero, or False.
- Enter password, the 2-digit root number, the 2-digit value type, the 4-digit value number, the 4-digit %true+macro name, and, optionally, the 4-digit %false+macro name.

### Command Form:

Command	Form	Data Digit
If-Then-Else	(PW) 76 ww xxxx yyyy [zzzz] *	ww = value type number (see table below) xxxx = value to test (see table below) yyyy = %true+macro zzzz = %false+macro (optional)

### Value Types:

Type Number	Type Name	Value To Test	True Condition	False Condition
00	Timers	Timer Number. (See the description on page 3-15 and the timer command and summary table starting on page A-41).	Greater Than Zero	Zero
03	Software Switch	Software Switch Number. (See the description on page 3-9 and the software switch command and summary table starting on page A-46.)	Enabled Set One On	Disabled Cleared Zero Off
04	Boolean	Boolean Number. (See the description on page 3-11 and the summary table starting on page A-50.)	Set One On Active	Cleared Zero Off Inactive
05	Scheduler Setpoint Enable	Scheduler Setpoint Number. (See page 22-7.)	Enabled	Disabled
06	User Timers	Timer Number. (See page 20-1)	Running	Stopped

**Acknowledgment:** None

### Errors:

Error	Meaning
? err 1	wrong number of digits entered
? err 2	illegal digit entered

**Default Condition:** N/A

**Example #1, Test for a path to be timed out:**

To test the value of the RX1-TX1 Timeout Timer (#2100) and execute macro 9045 if the Timer is not zero, enter:

```
(PW) 76 00 2100 9045 *
```

You can also test the RX1-TX1 Timeout Boolean (#0114) and execute macro 9045 if the boolean is set. Enter:

```
(PW) 76 00 2100 9045 *
```

**Example #2, Test for a Timeout Timer Enabled:**

To test the value of the RX1-TX2 Timeout Timer Enable Software Switch (#0251) and execute macro 2345 if the switch is set, enter:

```
(PW) 76 03 0251 2345 *
```

**Example #3, Test the internal battery condition:**

To test the value of the Battery Good Boolean (#0012) and execute macro 1234 if the boolean is a one (on), enter:

```
(PW) 76 04 0012 1234 *
```

**Example #4, Test if a Scheduler Setpoint is enabled:**

To test the value of the Scheduler Setpoint number 23 Enable (#0023) and execute macro 3456 if the setpoint is enabled, enter:

```
(PW) 76 05 0023 3456 *
```

**Example #5, Speak the state of a boolean:**

You can create a set of macros that speak the state of a boolean. This can be used for any of the value types listed to read back settings and current state. In this example, the following macros play a speech message whether Logic Output #1 is On or Off:

```
; Speak "Logic Output 1", then "Off" or "On"  
(PW) 20 1234 DD 15 9960 1027 1190 0001 *  
(PW) 29 1234 DD 76 04 0001 9001 9000 *  
(PW) 20 9000 DD 15 9960 0314 *  
(PW) 20 9001 DD 15 9960 0315 *
```

**Example #6, Restricting macros to being executed on specific ports:**

You can write a macro that works on one or more ports. The macro will check each %Command is executing on this port+boolean. The following macro executes macro A001 only on port 3 and port 9 (serial), but not on port 1 or port 2:

```
(PW) 20 1234 DD 76 04 0300 A001 *
```



```
(PW) 29 1234 DD 76 04 0900 A001 *
```

**Example #7, Executing different macros on different ports from the same macro name:**

You can write a macro that can be executed from any port, but works differently for each port. The following macro forces the Identifier Initial ID Message to play for the port that it is executed on:

```
(PW) 20 0033 DD 76 04 0100 9001 *  
(PW) 29 0033 DD 76 04 0200 9002 *  
(PW) 29 0033 DD 76 04 0300 9003 *  
(PW) 29 9001 DD 63 0114 1 *  
(PW) 29 9002 DD 63 0214 1 *  
(PW) 29 9003 DD 63 0314 1 *
```

---



---

## Set/Clear User Software Switch

Sets or clears the specified User Software Switch.

- There are 40 User General Purpose Software Switches and another 10 for each port for a total of 70 User Software Switches.
- User switches have no direct effect on the operation of the controller. They can be tested in the If-Then-Else command to alter the execution of macros depending on whether they are ON or OFF.
- Enter the password, the 2-digit root number, the 4-digit software switch number, and one digit, 0 for OFF (disabled), 1 for ON (enabled).

---



---

### Command Form:

Command	Form	Data Digit
Set/Clear User General Purpose Software Switch 60 thru	(PW) 63 0060 x *	x = 0 = OFF (cleared) x = 1 = ON (set)
Set/Clear User General Purpose Software Switch 99	(PW) 63 0099 x *	
Set/Clear User Port-Specific Software Switch 90 thru	(PW) 63 0t90 x *	t = 1,2,3 x = 0 = OFF (cleared) x = 1 = ON (set)
Set/Clear User Port-Specific Software Switch 99	(PW) 63 0t99 x *	

**Acknowledgment:** Sends *OK* message

### Errors:

Error	Meaning
? err 1	wrong number of digits entered
? err 2	illegal digit entered

**Default Condition:** All User Switches are OFF (cleared)

**Example #1, Master enable for a group of macros:**

A system owner can define a set of macro names that provide repeater users with functions that can be enabled or disabled as a group. A User Software Switch can be set or cleared by the system owner to control when these macros can be executed. Each of the macros will check to determine if the User Software Switch has been set before executing the commands in that macro. In this way, the system owner can disable these user functions.

This example can be used to allow a user to `%log in+` by executing a personal macro that sets a switch to allow his groups of macros to be executed. When he executes another personal macro to `%log off+` clearing the switch, his group of macros can no longer be executed.

For this example, User Software Switch #90 is used as the system owner's master enable for these macros. The macro name that the system owner publishes to his users is 1234. The macro name that implements the function is A123. (I selected these names at random. You can choose any valid names.)

To set this switch, the system owner would enter:

```
(PW) 63 0090 1 *
```

To clear this switch, the system owner would enter:

```
(PW) 63 0090 0 *
```

A user would execute macro 1234. The macro would check this switch using the following command:

```
(PW) 20 1234 DD 76 03 0090 A123 *
```

When the switch is set, that command would execute the `%true+macro A123` that implements the function. Since we did not specify a `%false+macro`, nothing else would be executed when the switch is cleared. You could add a `%false+macro` to announce `%Function Disabled+`.

Another use of this example is to implement *Pre-Access*. See the examples on the following pages for a description and when you might use this function.

**Example #2, Pre-Access:**

*Pre-access* is a controller function that is commonly used when a number of controllers are all listening to the same audio source as in a linked repeater system. All controllers implement the same macro names as a common set of control operator commands, but only one site at a time is selected.

For example, your main site might be assigned the macro name 1\*, the second site might be 2\*, and so on. The macro 1 and 2 are the master enables for the group of commands that are common across all your controllers. Only one of the master enables would be executed on one of the controllers at a time.

You could allow the site to be selected for the entry of only a single command, or you might require another code like 0\* to deselect all controllers, or you might implement a User Timer that will deselect the site after some number of seconds. This solution is very flexible. There are many options.

For this example, User Software Switch 90 is used as the system owner's master enable for the common macros. The macro names that selects the sites are 1, 2, 3, and so on. The macro name that deselects all sites is 0. The macro name that is the common remote command is 200. The macro name that actually implements the common function is A200. (I selected these names at random. You can choose any valid names.)

To select a site, the site select macros each set this switch on their specific controller. Create each of these on a different controller.

```
(PW) 20 0001 DD 63 0090 1 * ; Site #1
(PW) 20 0002 DD 63 0090 1 * ; Site #2
(PW) 20 0003 DD 63 0090 1 * ; Site #3
(PW) 20 0004 DD 63 0090 1 * ; Site #4
(PW) 20 0005 DD 63 0090 1 * ; Site #5
(PW) 20 0006 DD 63 0090 1 * ; Site #6
```

Macro 200 would check switch #90 using the following command:

```
(PW) 20 0200 DD 76 03 0090 A200 *
```

And that command would execute the %true+macro A200 that implements the function, then turns off the site selection. (I chose the RX1-TX1 Timeout Timer Reset command for this example.)

```
(PW) 20 A200 DD 63 0171 1 *
(PW) 29 A200 DD 63 0090 0 *
```

The 200 macro will not do anything at any site that doesn't have its software switch set. In this example the Software Switch only stays on for one command. Each new command you enter needs another prefix.

**Example #3, Pre-Access With Deselect:**

We can modify the previous example so that a site will stay selected until the user executes a macro to deselect all sites. This macro clears the switch and is present on all controllers:

```
(PW) 20 0000 DD 63 0090 0 *
```

You would use the following macro instead of having each of your command macros clear the switch. Our example macro of A200 from above then would look like this:

```
(PW) 20 A200 DD 63 0171 1 *
```

In case you selected a site, then selected another site, you could have the other sites all deselect if a command wasn't executed. For example, site #1 would have these commands (extend the example for more sites):

```
(PW) 20 0001 DD 63 0090 1 * ; Site #1
(PW) 20 0002 DD 63 0090 0 * ; Site #2
and so on...
```

Site #2 would have these commands:

```
(PW) 20 0001 DD 63 0090 0 * ; Site #1
(PW) 20 0002 DD 63 0090 1 * ; Site #2
and so on
```

**Example #4, Pre-Access With Command Timer:**

We can expand this example with a controller User Timer (see page 20-1) that allows multiple common commands to be entered to control a site, but where each subsequent command must be entered within some number of seconds (10 seconds in this example) or the site selection is disabled. One time during controller programming, we will configure the User Timer timeout and macro that is executed when it times out:

```
(PW) 49 00 03 100 * ; 10 seconds
(PW) 49 00 02 0 * ; execute macro 0 to deselect
```

Then the example macro of A200 from above would look like this:

```
(PW) 20 A200 DD 63 0171 1 * ; function
(PW) 29 A200 DD 49 00 01 * ; retrigger timer
```

**Example #5, Pre-Access With Messages:**

We can expand this example with the addition of a speech message as feedback to the user so that the user knows that the site select macro was executed. You can add a 1 second dialtone message to be played, like this:

```
(PW) 29 0001 DD 15 999310 9915 57 0018 0036 95 *
```

---



---

## Pause and Cancel Pause

Causes the controller to stop the execution of the commands that follow in the command queue for the programmed amount of time.

- The Pause command results in a delay occurring between commands in a command queue.
- The Cancel Pause command can be entered from another command input to cancel a currently executing pause command in another command queue.
- To enter a Pause command, enter the password, the two-digit root number, the digit %**0**+, and a one-to-five-digit time value corresponding to the number of 0.01 second (10 millisecond) intervals of pause desired.
- To enter a Cancel Pause command, enter the password, the two-digit root number, the digit %**1**+, and the command port where the pause command was entered.

---



---

### Command Form:

Command	Form	Data Digit
Pause	(PW) 98 0 xxxxx *	(0. 65535) = (0. 655.35) seconds
Cancel Pause	(PW) 98 1 x *	1 = DTMF 1 2 = DTMF 2 3 = DTMF 3 9 = Serial

**Acknowledgment:** Sends OK message

### Errors:

Error	Meaning
? err 1	wrong number of digits entered
? err 2	illegal digit entered

**Default Condition:** No Pause

### Examples:

To delay command processing for 2 seconds on the port that the Pause command is executed, enter:

```
(PW) 98 0 200 *
```

To delay command processing in the middle of a macro for a half second, enter:

```
(PW) 29 1234 DD 98 0 50 *
```

To cancel a Pause command entered by DTMF on port #2, enter this command on any other port:

```
(PW) 98 1 2 *
```

---



---

## Assign Power ON-Triggered Macro

Assigns a macro to be executed when the controller goes through a Warm Start or a Power Cycle.

- A Warm Start occurs when you press the RESET pushbutton on the back of the controller or you turn on the power to the controller.
- Enter the password, the 2-digit root number, the 4-digit event-triggered macro number, and the 4-digit macro name desired. Use leading zeros if needed.
- If you wish to unassign a previously assigned macro, enter just the password, the 2-digit root number, the 4-digit event-triggered macro number, and the (\*).

---



---

### Command Form:

Command	Form
Assign Power ON-Triggered Macro	(PW) 26 0000 (macro name) *

**Acknowledgment:** Sends OK message

### Errors:

Error	Meaning
? err 1	wrong number of digits entered
? err 2	illegal digit entered

**Default:** None

### Examples:

This command is useful for initializing hardware at the repeater site following a power interruption. A macro can be created that momentarily switches ON one of the logic outputs; this macro is then triggered by a restart. By the way, this command has no effect after a cold start since all macros are deleted anyway.

As an example of how this command may be used, assume that macro 3456\* has been created. This command changes the CW frequency to a high pitch or the speed of the CW ID. To trigger this macro from a restart enter:

```
(PW) 26 0000 3456 *
```

If power at the repeater site should fail and return later, the higher CW pitch will notify you about the power failure. You could run a macro or a single control command that restores the CW pitch back to normal.

Another use for this command is to restore a normal system configuration after power is restored.

**Example:** Transmitter not allowed to transmit for first 30 seconds.

Some transmitters cannot be allowed to be keyed for some time after first being powered on. Tube transmitters are one of these types.

Using the Powerup Event-Triggered Macro, a macro can disable a transmitter for an amount of time that you specify.

```
; erase the powerup message
99 31 0000

; setup a delay timer
99 49 00 03 300 * ; Set timer #00 to 30.0 seconds
99 49 00 02 A001 * ; Execute macro when the timer times out

; Powerup Macro
99 26 0000 A000 * ; Execute macro on restart

99 21 A000 *
99 20 A000 99 63 0112 0 * ; Disable PTT #1
99 29 A000 99 49 00 04 * ; Start Timer in One-Shot mode

; Delayed Powerup Macro and Reset Message
99 21 A001 *
99 20 A001 99 63 0112 1 * ; Enable PTT #1
99 29 A001 99 15 9960 0148 0368 1293 ; Speak message
```



## Long Names

The controller provides macros to simplify common operations. Macro names are limited to up to four DTMF digits. Sometimes longer names are desired for improved security or required to accept DTMF digits from external hardware like a dispatch console.

Long Names have the following characteristics:

- Up to ten names can be defined from one to eight DTMF digits long.
- Each name can cause a macro to be executed when it is decoded.
- Each name can be enabled or disabled.
- Each name can be restricted to only be accessible from a specific radio port.

Decoding is slightly different than with Macro Names. The entered digits must match the configured long names exactly. Leading zeros in Long Names are required to be entered.

---



---

## Select and Control Long Names

### Configure Long Names

- To enable or disable a name, enter the password, the two-digit root number, the two-digit name number, the two-digit opcode, the one-digit enable/disable value, and the (\*).
- To set the digits of a long name, enter the password, the two-digit root number, the two-digit name number, the two-digit opcode, from one to eight digits of the long name desired, and the (\*).
- To set the event macro name, enter the password, the two-digit root number, the two-digit name number, the two-digit opcode, the four-digit macro name desired, and the (\*).
- To set the port list, enter the password, the two-digit root number, the two-digit name number, the two-digit opcode, digits 1, 2, and/or 3 to specify the ports that will decode this long name, and the (\*).
- To unassign a previously assigned name, enter just the password, the two-digit root number, the two-digit name number, the two-digit opcode, and the (\*).
- To unassign a previously assigned event macro, enter just the password, the two-digit root number, the two-digit name number, the two-digit opcode, and the (\*).
- 

---



---

### Command Form:

Command	Form	Data Digit
Set Enable/Disable	(PW) 46 (name) 00 1/0 *	See table below
Set Long Name	(PW) 46 (name) 01 (name digits) *	See table below
Set Event Macro	(PW) 46 (name) 02 (macro name) *	See table below
Set Port Access	(PW) 46 (name) 03 (port list) *	See table below

Data Digit	Explanation
name, 00-09	Select one of 10 names, 2 digits are required
name digits	0-9, A-D
macro name	The name of the macro to be triggered
port list	List of port numbers where this name can be decoded

**Acknowledgment:** Sends *OK* message

**Errors:**

Error	Meaning
? err 1	wrong number of digits entered
? err 2	illegal digit entered

**Default Condition:** the long name is undefined and disabled.

**Example:**

To set long name 3 to the digits 123456 to execute macro AB12 only on port 2, enter:

```
(PW) 46 03 00 1 *           ; Enable Name
(PW) 46 03 01 123456 *      ; Set Name
(PW) 46 03 02 AB12 *       ; Set Event Macro
(PW) 46 03 03 2 *         : Set Port List
```

## Backup Battery Monitoring

Your 7330 controller contains a 3 volt lithium coin cell (BR2032 or CR2032) that protects your configuration during a power loss. It also keeps the real-time clock running without power being applied to the controller.

The battery monitor circuit in the 7330 checks the voltage of the battery once per day. When the voltage drops below 2.3V, a battery warning is generated. At this voltage, your configuration is still protected, but the battery should be replaced soon.

You can check the battery warning in two different ways: execute a macro or check a boolean.

### Executing a Macro

You can have the controller execute a macro when the battery warning is asserted. There's no way to predict what time of day the macro will execute. You could have the macro change the courtesy tone to the CW letter %B+, or add an ID Tail Message, or a Transmitter Dropout Message to get your attention.

For example, to program a message that changes the courtesy tone on path 1 to the CW letter %B+ when the battery warning asserts, enter:

```
(PW) 20 3456 (PW) 31 0100 9900 11 *
(PW) 26 0001 3456 *
```

See the *Select Battery Warning-Triggered Macro* command on the next page.

### Query the Current Battery State

You can also check the current state of the battery using a macro and having the If/Then/Else command check the Battery Good Boolean.

For example, the following macro will speak the state of the battery as %Battery Good+ or %Battery Warning+:

```
(PW) 20 00BB DD 76 04 0012 2001 2000 *
(PW) 20 2001 DD 15 9960 0225 0860 *
(PW) 20 2000 DD 15 9960 0225 0373 *
```

To execute this macro, enter:

```
BB *
```

See the *If-Then-Else* command on page 5-21.

## Assign Battery Warning-Triggered Macro

Assigns a macro to be executed when the controller detects that the backup battery 3 volt lithium coin cell has discharged below 2.3 volts and must be replaced.

- Enter the password, the 2-digit root number, the 4-digit event-triggered macro number, and the 4-digit macro name desired. Use leading zeros if needed.
- If you wish to unassign a previously assigned macro, enter just the password, the 2-digit root number, the 4-digit event-triggered macro number, and the (\*).

### Command Form:

Command	Form
Assign Battery Warning-Triggered Macro	(PW) 26 0001 (macro name) *

**Acknowledgment:** Sends *OK* message

### Errors:

Error	Meaning
? err 1	wrong number of digits entered
? err 2	illegal digit entered

**Default:** None

### Examples:

To execute macro 3456\* when the backup battery warning asserts, enter:

```
(PW) 26 0001 3456 *
```

To erase this macro, enter.

```
(PW) 26 0001 *
```

---



---

## Controller Restarts

These commands reset the controller as a *Warm Start* or as a *Power Cycle*. No programming is modified by these commands.

- The Controller Warm Start command reloads the repeater firmware from flash memory and initializes its temporary storage. This command does the same thing as pressing the RESET pushbutton on the controller.
  - The Controller Power Cycle command resets the controller's system-on-a-chip then does a Controller Warm Start. This command does the same thing as removing then applying power to the controller.
  - Enter the password and the 4-digit root number.
- 
- 

### Command Form:

Command	Form
Controller Warm Start	(PW) 95 00 *
Controller Power Cycle	(PW) 95 42 *

**Acknowledgment:** Sends *OK* message

### Errors:

Error	Meaning
? err 1	wrong number of digits entered
? err 2	illegal digit entered

**Default:** None

### Examples:

To perform a Warm Start of the controller, enter the command:

```
(PW) 95 00 *
```

To perform a Power Cycle of the controller, enter the command:

```
(PW) 95 42 *
```

---

## Chapter 6

# Messages

---

Each of the 7330's three ports has a very flexible *message system* that allows it to transmit messages independently on each of the ports.

Each message system consists of a first-in, first-out *message buffer* (an area of memory that holds queued messages) and a *message handler* (a program that parses the messages and operates the appropriate hardware to transmit them).

Unlike many controllers, you're not limited to a small set of characters and beeps. Any message can contain CW characters, single- and dual-tone beeps, DTMF characters, paging tones, and standard and custom speech.

You can change the 7330's default values for CW speed, CW frequency, beep duration, beep frequency, audio level, and so on. You can also change these values within messages with *control characters*. And you can also change which ports a message is heard on by changing the *routing control characters*.

In this chapter, you will find instructions for generating the following message and paging types:

- CW (Morse Code)
- Single-Tone Beep
- Dual-Tone Beep
- Single-Tone Page
- Two-Tone Sequential Page
- 5/6-Tone Page
- DTMF Page
- SELCAL Page
- Speech
- Speech Run-Time Variables

## Control Characters

You put *control characters* into a message when you want to send special instructions to the message handler. Control characters are identified by their leading digits (97, 98 or 99), and are used to select the type of message, change the audio level, and so on.

---

**Note:** Control characters are only used within messages. Don't confuse control characters with the default password (99) that is used initially to enter commands.

---

Any message can have one or more control characters. The message handler obeys control characters *as it finds them* in the message. Since it doesn't look ahead to see if you will be changing any conditions, the control character(s) must appear ahead of the affected portion of the message.

Control characters and their descriptions are discussed next. You're encouraged to use them in all messages so that the messages are well defined. The message handler will use defaults for certain items if it doesn't find them programmed into the message. For example, if the message type isn't indicated, the controller will send the message in CW.



<b>Message Control Characters</b>		
<b>Control Character</b>	<b>Definition</b>	<b>Page</b>
97xx	Message Routing port numbers follow	6-4
9900	CW characters follow	6-13
9901	CW Primary characters follow	6-13
9902	CW Secondary characters follow	6-13
9903	CW Speed Change characters follow	6-15
9904	CW Frequency Change characters follow	6-15
9905	CW Message Level characters follow	6-14
9910	Single-Tone Beep characters follow	6-21
9911	Single-Tone Beep Primary characters follow	6-21
9912	Single-Tone Beep Secondary characters follow	6-21
9913	Single-Tone Beep Message Level characters follow	6-22
9915	Dual-Tone Beep characters follow	6-31
9916	Dual-Tone Beep Primary characters follow	6-31
9917	Dual-Tone Beep Secondary characters follow	6-31
9918	Dual-Tone Beep Message Level characters follow	6-32
9920	Single-Tone page follows	6-39
9930	Two-Tone Sequential page follows	6-41
9940	5/6-Tone page follows	6-43
9950	DTMF page follows	6-45
9955	SELCAL page follows	6-53
9960	Speech characters follow	6-55
9961	Speech Primary characters follow	6-55
9962	Speech Secondary characters follow	6-55
9963	Speech Message Level characters follow	6-56
9991	Mixed Audio Allowed	6-6
9992	Non-Mixed Audio Only	6-6
9993	Pause characters follow	6-7
9999	Queue for executing the macro that follows	6-8

Control characters 9900 through 9963 tell the message handler what kind of message you want. 9991 and 9992 chooses whether the message should be mixed with receiver audio. 9993 inserts a programmable delay in the message. 9999 synchronizes messages with macros.

## Message Routing Control Characters

Most predefined messages are port-specific. (See *Messages By Number* tables starting on page A-39.) These messages are automatically delivered to the appropriate port by the message handler without requiring you to provide explicit message routing instructions. These types of messages include ID Messages, Courtesy Beeps, Timeout Messages, Dropout Messages, Command Responses, and any messages queued from a macro that is executed from a DTMF command on a port.

But for messages queued from a macro that is executed from the DTMF decoder, the scheduler, an event macro, or entered from the serial port, that you want to go to other ports, you must specify one or more destination ports using the *Message Routing Control Characters* defined in this section.

You can use the *Message Routing Control Characters* to route entire messages; partial message routing is not supported. The control characters must be the first characters in the message. If the *Message Routing Control Characters* are inserted into the middle of a message, they will be ignored.

---

**Note:** For 7K owners: 7330 Message Routing works differently than 7K message routing control characters.

---

### Route To A Single Port

The format for *Message Routing Control Characters* to route a message to a single port is as follows:

- Enter 97 x0
- The digit shown as %~~0~~+ represents the destination port number.
- Note that the %~~0~~+ after the %~~0~~+ port number is a required placeholder so that there are an even number of characters in the message.

For example, to route a message to transmitter 2 (9910 16 is a sample message):

```
9720 9910 16
```

To route a message to transmitters 1 and 3 (9910 16 is a sample message):

```
9713 9910 16
```

To route a message to transmitters 1, 2 and 3 (9910 16 is a sample message):

```
971230 9910 16
```

### **Route To Two Ports**

The format for Message Routing Control Characters to route a message to two ports is as follows:

- Enter 97 xy
- The digits shown as %~~0~~+ and %~~0~~+ represent the port numbers.

For example, to route a message to transmitters 2 and 3 (9910 16 is a sample message):

```
9723 9910 16
```

### **Route To Three Ports**

The format for Message Routing Control Characters to route a message to a three ports is as follows:

- Enter 97 xy z0
- The digits shown as %~~0~~+, %~~0~~+, and %~~0~~+ represent the destination port numbers.
- Note that the %~~0~~+ after the %~~0~~+ port number is a required placeholder so that there are an even number of characters in the message.

For example, to route a message to transmitters 1, 2 and 3 (9910 16 is a sample message):

```
971230 9910 16
```

## Audio Mixing Control Characters

For each message, or portion of a message, you can specify whether the message should be mixed with receiver audio or whether the receiver audio should be muted during the message (non-mixed).

Most users expect CW messages, beeps and perhaps speech messages to be mixed with receiver audio, since sending them non-mixed would mute receiver audio for the duration of the message. However, pages, announcements, and so forth may be sent non-mixed to ensure they are received and decoded properly.

### Mixed Audio

The format for mixed audio control characters is as follows:

- Enter 9991.

For example, to play a courtesy beep mixed with receiver audio, enter the following message characters:

```
9991 9910 16
```

### Non-Mixed Audio

The format for non-mixed audio control characters is as follows:

- Enter 9992.

For example, to play a DTMF page non-mixed, ie. all receiver audio is muted during the DTMF page, enter the following message characters:

```
9992 9950 01 02 03
```

### Defaults

This table shows the default mixing for each message type.

Message Type	Default
CW	Mixed
Single-Tone Beep	Mixed
Dual-Tone Beep	Mixed
Single-Tone Page	Non-Mixed
Two-Tone Page	Non-Mixed
Five-Six Tone Page	Non-Mixed
DTMF Page	Non-Mixed
SELCAL Page	Non-Mixed
Speech Playback	Mixed

## Pause Control Characters

### Control Character

A configurable delay maybe be inserted before a message or between two messages.

### Format

The format for a Pause Control Character is as follows:

- Enter 9993 xx.
- The two digits shown as %x+represent the time delay in 100 millisecond (one-tenth second) increments, 00 thru 99.

For example, to insert a 1 second delay into a message, enter the digits:

```
9993 10
```

To insert a 2 second delay between two messages, enter the digits:

```
9960 0858 9993 20 9960 0271
```

### Defaults

There are no pauses entered into messages by default.

The message type following the Pause Control Character sequence is CW.

## Synchronizing Messages and Commands

In the controller, the Message Handler processes messages from the Message Buffer. The Command Executive processes commands and macros from the Execution Queue. These queues are processed independently but simultaneously. Messages and commands queued at the same time and expected to operate in sequence can have unexpected results unless you use the message control character to keep everything in synchronization.

Suppose you want to send a DTMF page of %234+, then turn on logic output number 1. You might create a macro like this one:

```
(PW) 20 9000 (PW) 15 9950 01 02 03 04 *  
(PW) 29 9000 (PW) 70 01 *
```

However, this command sequence will not give you the expected results. The first command sends the DTMF page to the message buffer for execution. The second immediately executes the command to turn on the logic output. The logic output will change before the DTMF page is completed.

To force the second command in the macro to wait until after the first command has sent the DTMF page, you create two macros, 9000 and 9001:

```
(PW) 20 9000 (PW) 15 9950 01 02 03 04 9999 9001 *  
(PW) 20 9001 (PW) 70 01 *
```

%9999+in the macro 9000 is a message control character that causes a macro to be executed when the message handler reaches that point in the message. The %0001+that follows the 9999 message control character is the name of the macro to execute. This sequence operates as expected because the DTMF page will complete before the command to turn on the logic output is executed.

---

**Note:** Macro names used with message control character 9999 must be 4 digits long. Insert leading zeros if needed.

---

This type of sequencing also has uses in paging macros that set a CTCSS tone, then send a DTMF page as the message to be displayed on the dialed digital pager.

## Interruptable Messages

Most messages sent by the 7330 are not interruptable and we don't want them to be. For example, an Identifier Message must be played (in most countries) to meet the identification requirements of that region. Or when we enter a command, we want to hear an acknowledgement of the action we requested.

With all the speech capabilities of the 7330, it's tempting to use speech for all messages. But sometimes a long speech message gets in the way of real communications.

An *Interruptable Message* is a message that will play to completion on a transmitter if no activity is detected on any pathed input. When activity is detected, the message immediately stops playing and may optionally be replaced with an alternate message.

*Interruptable Messages* are supported in *CW*, *Beep*, *Dual-Tone Beep*, and *Speech* messages.

### Primary Message

A *Primary Message* defines the interruptable portion of a message. This message is defined just like any other message of its type except that the message handler will immediately terminate this message if activity is detected from any pathed input. The control characters for a primary message are:

Message Type	Control Characters
CW	9901
Single-Tone Beep	9911
Dual-Tone Beep	9916
Speech Playback	9961

### Secondary Message

A *Secondary Message* defines the optional portion of an interruptable message. This message is defined just like any other message of its type except that the message handler will immediately begin playing this message in place of an interrupted primary message if activity is detected from any pathed input. This message is skipped if the primary message is not interrupted. The control characters for a secondary message are:

Message Type	Control Characters
CW	9902
Single-Tone Beep	9912
Dual-Tone Beep	9917
Speech Playback	9962

## Message Levels

*Messages Levels* can be set for each of the controller message types, e.g., CW, beep, speech, etc. Default values can be set by controller command (see page 6-11), or can be temporarily customized in each message via Message Level control characters (see the *Message Level* description in each message type described in the following pages).

### Message Level Values

The two digits in the %level+column of the following table are used in the *Set Default Message Level* command (see page 6-11) and following the *Message Level Control Characters* (above). Each 6 dB of reduction in level reduces the apparent message volume by half. 0 dB represents the fully-deviated level.

Message Levels									
Level	Value dB	Level	Value dB	Level	Value dB	Level	Value dB	Level	Value dB
00	0.0	20	-10.0	40	-20.0	60	-30.0	80	-40.0
01	-0.5	21	-10.5	41	-20.5	61	-30.5	81	-40.5
02	-1.0	22	-11.0	42	-21.0	62	-31.0	82	-41.0
03	-1.5	23	-11.5	43	-21.5	63	-31.5	83	-41.5
04	-2.0	24	-12.0	44	-22.0	64	-32.0	84	-42.0
05	-2.5	25	-12.5	45	-22.5	65	-32.5	85	-42.5
06	-3.0	26	-13.0	46	-23.0	66	-33.0	86	-43.0
07	-3.5	27	-13.5	47	-23.5	67	-33.5	87	-43.5
08	-4.0	28	-14.0	48	-24.0	68	-34.0	88	-44.0
09	-4.5	29	-14.5	49	-24.5	69	-34.5	89	-44.5
10	-5.0	30	-15.0	50	-25.0	70	-35.0	90	-45.0
11	-5.5	31	-15.5	51	-25.5	71	-35.5	91	-45.5
12	-6.0	32	-16.0	52	-26.0	72	-36.0	92	-46.0
13	-6.5	33	-16.5	53	-26.5	73	-36.5	93	-46.5
14	-7.0	34	-17.0	54	-27.0	74	-37.0	94	-47.0
15	-7.5	35	-17.5	55	-27.5	75	-37.5	95	-47.5
16	-8.0	36	-18.0	56	-28.0	76	-38.0	96	-48.0
17	-8.5	37	-18.5	57	-28.5	77	-38.5	97	-48.5
18	-9.0	38	-19.0	58	-29.0	78	-39.0	98	-49.0
19	-9.5	39	-19.5	59	-29.5	79	-39.5		

### Defaults

See the table on page 6-12.



---



---

## Set Default Message Level

Selects the default level for each of the controller message types for each port.

- You can set the default level to a specific value (see *Message Levels* table).
- Enter the password, followed by the 2-digit root number, the 4-digit level control number, and the 2-digit level code.
- The level is taken from the table on page 6-10. Do not omit leading zeroes.

---



---

### Command Form:

Command	Form	Data Digits
Select Default CW Level	(PW) 10 0x00 yy *	x = transmitter (1,2,3) yy = level (see table)
Select Default Single-Tone Beep Level	(PW) 10 0x01 yy *	
Select Default Dual-Tone Beep Level	(PW) 10 0x02 yy *	
Select Default Single-Tone Page Level	(PW) 10 0x03 yy *	
Select Default Two-Tone Page Level	(PW) 10 0x04 yy *	
Select Default Five/Six-Tone Page Level	(PW) 10 0x05 yy *	
Select Default DTMF Page Level	(PW) 10 0x06 yy *	
Select Default SELCAL Page Level	(PW) 10 0x07 yy *	
Select Default Speech Playback Level	(PW) 10 0x08 yy *	

**Acknowledgment:** Sends *OK* message

### Errors:

Error	Meaning
? err 1	wrong number of digits entered
? err 2	illegal code entered

**Defaults:**

Message Type	Default Level
CW Level	12 (-6dB)
Single-Tone Beep Level	12 (-6dB)
Dual-Tone Beep Level	12 (-6dB)
Single-Tone Page Level	06 (-3dB)
Two-Tone Page Level	06 (-3dB)
Five-Six Tone Page Level	06 (-3dB)
DTMF Page Level	06 (-3dB)
SELCAL Page Level	06 (-3dB)
Speech Playback Level	00 (0dB)

**Examples:**

To set the default CW level on transmitter #1 to -3 dB, enter:

```
(PW) 10 0100 06 *
```

To set the default Speech Playback level on transmitter #2 to 0 dB (the same level as repeat audio), enter:

```
(PW) 10 0208 00 *
```

## CW Messages

### Control Character

When creating a CW message, enter the control character 9900 ahead of the CW characters. (If a message does not contain a message type control character, the message will be sent in CW. Therefore, a CW-only message would not require the 9900. However, a message containing mixed types . a series of beeps followed by CW characters, for example . would require the 9900 ahead of the CW portion of the message.)

### Format

The format for CW messages is as follows:

- Enter the control character 9900, 9901, or 9902.
- Enter the desired CW character codes from the *CW Characters* table on page 6-16 to create the desired message.
- End the CW message with the (\*) character, or enter another control character, e.g. 99xx, and continue with another message type.

### Primary/Secondary (Interruptable) CW Messages

CW Messages can be defined to be non-interruptable or interruptable.

- A CW Message defined with the control character 9900 is not interruptable.
- A CW Primary Message, defined with a control character of 9901, will cease playback if any path is active to a transmitter associated with the message playback at the time the playback commences, or anytime during the playback.
- A CW Secondary Message, defined with a control character of 9902, will only play in circumstances when a primary message would not. A secondary message is optional. A primary message defined without a secondary message would immediately stop when interrupted . there would be no replacement message played.

For example, this identifier message would speak ~~W~~A1XYZ Repeater+, but if a receiver became active, the message would revert to ~~W~~A1XYZ+in CW:

```
(PW) 31 0110 9961 0067 0045 0001 0068 0069 0070 0342
9902 32 10 01 33 34 35 *
```

---

**Tip:** a secondary message is usually played when a user is speaking on the repeater. Add message level control characters before the secondary message so that it isn't as loud as the primary message.

---

## Pre-Message Delays

The 7330 has two methods of creating a pre-message delay.

In the first method, you can insert a %993 xx+Pause Control Code (see page 6-7) ahead of your message.

The second method makes use of a new timer called the *Transmitter Turn-On Message Delay* (see page 11-5). The timer starts when the PTT is activated, and when it expires, the *Message Handler* is allowed to proceed. The purpose of the delay is to hold off sending messages until the transmitter comes up to full power and any user's CTCSS decoder has unmuted his local audio. If a transmitter has been keyed beyond the turn-on delay when a message is queued, the message will be sent with no delay (unless the user has programmed one into the message). There are separate *Transmitter Turn-On Message Delay* commands for each transmitter, so the controller can handle slow or fast transmitters individually.

## Message Level

The CW Message Level may be changed before or during a CW message. This feature allows you to draw attention to a certain message or a part of a message.

- Enter %905 xx+ahead of the 9900/9901/9902 CW Control Characters.
- The two digits shown as %xx+represent the temporary message level and are taken from the *Message Levels* table on page 6-10.
- The message level may be changed as often as desired.

The temporary message level will stay in effect until either changed by other control codes, or until the CW message ends.

If you wish to change the CW Message Level for all CW messages, see the *Set Default CW Level* command on page 6-11.

## Wordspace Character

The *Wordspace Character*, 40, should be placed between the words in a CW message. The message handler will automatically place a wordspace at the end of a CW message, so you won't have to remember to do so. This feature prevents two adjacent CW messages from being run together. Wordspace characters can be used as pauses in a CW message, but the duration of the pause will depend upon the current sending speed of the CW.

## Frequency Change

The CW frequency (pitch) may be changed before or during a CW message. This feature allows you to draw attention to a certain message (or part of a message).

- A 6-digit character, 59xxxx, should be entered ahead of the CW characters that are to be sent at the new frequency.
- An alternate way to temporarily change the CW pitch is to enter 9904 xxxx ahead of the 9900 CW Control Characters.
- The four digits shown as %xxx+ represent the new frequency and are taken from the *Tone Code Tables* on pages A-31 and A-33.
- The frequency may be changed as often as desired within a CW message (even between each character).

The temporary frequency will stay in effect until either changed by other control codes, or until the CW message ends. Thus, if you will be using the Frequency Change feature, it is a good practice to specify the frequency for *each* CW message

If you wish to change the CW frequency for all CW messages, see the *Select Frequency of CW* command on page 6-18.

## Speed Change

The CW sending speed in WPM (words per minute) may be changed before, or during, a CW message. The speed may be varied from 5 to 40 WPM in ten steps. This feature allows you to draw attention to a certain CW message, or make it more easily copied by those with modest CW skills.

- To temporarily change the sending speed of a CW message, enter a 2-digit character from 60 to 69 ahead of the CW characters that are to be sent at the new speed.
- An alternate way to temporarily change the sending speed is to enter 9903 followed by 0x where x is one of the Speed Change Table entries used with the *Select CW Speed* command on page 6-19.
- The speed may be changed as often as desired within a CW message (even between each character).

The temporary sending speed will stay in effect until either changed by other control codes, or until the CW message ends. Thus, if you will be using the *Speed Change* feature, it is a good practice to specify the frequency for *each* CW Message.

If you wish to change the sending speed for all CW messages, see the *Select CW Speed* command on page 6-19.

## CW Characters

The CW library contains 55 characters and includes the numerals 0 through 9, the letters A through Z, punctuation, and standard Morse abbreviations.

- Each character is represented by a 2-digit code from 00 to 54.
- Do not omit leading zeroes.

The following table lists the CW characters and their codes.

CW Characters						
Control Character 9900/9901/9902						
Character	Code	Character	Code	Character	Symbol	Code
0	00	I	18	Period	.	36
1	01	J	19	Comma	,	37
2	02	K	20	Fraction	/	38
3	03	L	21	Question	?	39
4	04	M	22	Word space		40
5	05	N	23	End-of-message	(AR)	41
6	06	O	24	Wait	(AS)	42
7	07	P	25	Break	(BK)	43
8	08	Q	26	Double dash	(BT)	44
9	09	R	27	End-of-work	(SK)	45
A	10	S	28	Hyphen	-	46
B	11	T	29	Colon	:	47
C	12	U	30	Semicolon	;	48
D	13	V	31	Parenthesis	( )	49
E	14	W	32	Apostrophe	q	50
F	15	X	33	Exclamation	!	51
G	16	Y	34	Quotation	+	52
H	17	Z	35	Understood	(SN)	53
				At-symbol	@	54

## CW Frequency Change and Speed Change Characters

The following table shows *CW Frequency and Speed Change Characters* and their codes.

<b>CW Frequency Change</b>	
Control Character 9900/9901/9902	
<b>Change</b>	<b>Code</b>
Frequency	59xxxx (xxxx = tone code)

<b>CW Speed Change</b>	
Control Character 9900/9901/9902	
<b>Change</b>	<b>Code</b>
Speed to 5 WPM	60
Speed to 7 WPM	61
Speed to 10 WPM	62
Speed to 13 WPM	63
Speed to 15 WPM	64
Speed to 17 WPM	65
Speed to 20 WPM (default)	66
Speed to 24 WPM	67
Speed to 30 WPM	68
Speed to 40 WPM	69

---



---

## Select Frequency of CW

Changes the frequency (pitch) of the CW.

- Enter the password, followed by the 4-digit root number shown, followed by the 4-digit tone code for your desired frequency.
- The tone code is taken from the *Tone Code Tables* on pages A-31 and A-33. Do not omit leading zeroes.
- The frequency range is 300 Hz to 3 kHz.
- To select frequencies for the Owner-Fixed Frequency Beeps, see page 6-28. To select the frequency of CTCSS, see page 13-5.

---



---

### Command Form:

Command	Form	Data Digits
Select Frequency of CW for TX 1	(PW) 06 10 xxxx *	Tone Code Tables
Select Frequency of CW for TX 2	(PW) 06 20 xxxx *	
Select Frequency of CW for TX 3	(PW) 06 30 xxxx *	

**Acknowledgment:** Sends *OK* message

### Errors:

Error	Meaning
? err 1	wrong number of digits entered
? err 2	illegal code entered

**Default Condition:** CW Frequency is 1500 Hz; Tone Code is 0248

### Examples:

Let's change the frequency of the CW to 1200 Hz. The tone code for 1200 Hz is 0188. The command is:

```
(PW) 06 00 0188 *
```



---



---

## Select CW Speed

**Select CW Speed changes the speed at which CW messages are sent.**

- A single digit from 0. 9 programs the desired speed.
- See the *CW Speed Table* below.

---



---

### Command Form:

Command	Form	Data Digit
Select CW Speed for TX 1	(PW) 12 10 x *	CW Speed Table
Select CW Speed for TX 2	(PW) 12 20 x *	
Select CW Speed for TX 3	(PW) 12 30 x *	

Data Digit	CW Speed	Data Digit	CW Speed
0	5 WPM	5	17 WPM
1	7 WPM	6	20 WPM
2	10 WPM	7	24 WPM
3	13 WPM	8	30 WPM
4	15 WPM	9	40 WPM

---

**Note:** The *CW Speed Table*, above, is based on the number of milliseconds duration of an element of CW (dit = 1 element, dah = 3 elements). Five WPM corresponds to 240 ms/element, 7 WPM corresponds to 170 ms/element, 10 WPM corresponds to 120 ms/ element, and so on.

---

**Acknowledgment:** Sends *OK* message

### Errors:

Error	Meaning
? err 1	wrong number of digits entered
? err 2	illegal digit entered

### Default Condition:

Command	Default Condition
Select CW Speed	20 WPM

**Examples:**

To change the CW sending speed for transmitter #1 to 17 words per minute, enter:

```
(PW) 12 10 5 *
```

---

**Note:** There are two ways to change the speed of a CW message. One way is to use the command shown above; this is usually done upon installation to set the default CW rate for each transmitter. The other method is to insert a CW speed change control character into the message. The latter is a temporary method, since the speed returns to normal after the message is sent.

---

## Single-Tone Beep Messages

### Control Character

The control character 9910 must be entered before the actual beep characters when building a single-tone beep message.

---

**Note:** Any message that does not have a control character will be interpreted as a CW message.

---

### Format

The format for one or more single-tone sequential beep messages is as follows:

- Enter the control character 9910, 9911, or 9912.
- Then enter the various single-tone beep character codes described in the single-tone beep character tables that follow in this section.
- You may end the single-tone beep message with the (\*) character, or enter another control character, e.g. 99xx, and continue with another message type.

### Primary/Secondary (Interruptable) Single-Tone Beep Messages

Single-Tone Beep Messages can be defined to be non-interruptable or interruptable.

- A *Single-Tone Beep Message*, defined with the control character 9910, is not interruptable.
- A *Single-Tone Beep Primary Message*, defined with a control character of 9911, will cease playback if any path is active to a transmitter associated with the message playback at the time the playback commences, or anytime during the playback.
- A *Single-Tone Beep Secondary Message*, defined with a control character of 9912, will only play in circumstances when a primary message would not. A secondary message is optional. A primary message defined without a secondary message would immediately stop when interrupted. there would be no replacement message played.

For example, the message following sets the RX1 courtesy tone on TX1 as a primary single-tone beep message such that any activity on the repeater will cause the courtesy message to be discarded:

```
(PW) 31 0100 9911 76 24 *
```

## Single-Tone Beep Parameters (General)

The following table shows the general parameters related to single-tone beep messages. These parameters will be discussed in more detail in the sections that follow.

Single-Tone Beep Parameters (General)	
Control Character 9910/9911/9912	
Beep Parameter	Code
Custom Single-Tone Beep	57xxxxyy
Custom Single-Tone Beep delay	58xx
Automatic beep gap OFF (default)	55
Automatic beep gap ON	56

## Pre-Message Delays

The 7330 has two methods of creating a pre-message delay.

In the first method, you insert a %993 xx+Pause Control Code (see page 6-7) ahead of your message.

The second method makes use of a new timer called the *Transmitter Turn-On Message Delay* (see page 11-5). The timer starts when the PTT is activated, and when it expires, the Message Handler is allowed to proceed. The purpose of the delay is to hold off sending messages until the transmitter comes up to full power and any user's CTCSS decoder has unmuted his local audio. If a transmitter has been keyed beyond the turn-on delay when a message is queued, the message will be sent with no delay (unless the user has programmed one into the message). There are separate *Turn-On Delay* commands for each transmitter, so the controller can handle slow or fast transmitters individually.

## Message Level

The Single-Tone Beep Message Level may be changed before or during a Single-Tone Beep message. This feature allows you to draw attention to a certain message (or part of a message).

- Enter 9913 xx ahead of the 9910/9911/9912 Single-Tone Beep Control Characters.
- The two digits shown as %xx+represent the temporary message level and are taken from the *Message Levels* table on page 6-10.
- The message level may be changed as often as desired.

The temporary message level will stay in effect until either changed by other control codes, or until the Single-Tone Beep message ends.

If you wish to change the Single-Tone Beep Message Level for all Single-Tone Beep messages, see the *Set Default Single-Tone Beep Level* command on page 6-11.

## Fixed-Frequency Beeps

Forty-eight (48) beeps have been defined in frequency but have variable duration. These beeps are programmed with the character codes 00. 47 and range from 262 Hz to 3951 Hz. It is best to avoid beeps below 300 Hz and above 3000 Hz, since most radio systems are designed for 300. 3000 Hz response.

The following table shows the *Fixed Frequency Beeps*:

This table includes associated *note* values for each frequency. However, these note values are simply intended as a guide to the pitch of each beep and should not be construed as musical in nature.

Factory-Fixed Frequency Beeps								
Control Character 9910/9911/9912								
Freq (Hz)	Note	Beep	Freq (Hz)	Note	Beep	Freq (Hz)	Note	Beep
262	C3	00	659	E4	16	1661	G#5	32
277	C#3	01	698	F4	17	1760	A5	33
294	D3	02	740	F#4	18	1865	A#5	34
311	D#3	03	784	G4	19	1976	B5	35
330	E3	04	831	G#4	20	2093	C6	36
349	F3	05	880	A4	21	2217	C#6	37
370	F#3	06	932	A#4	22	2349	D6	38
392	G3	07	988	B4	23	2489	D#6	39
415	G#3	08	1046	C5	24	2637	E6	40
440	A3	09	1109	C#5	25	2794	F6	41
466	A#3	10	1175	D5	26	2960	F#6	42
494	B3	11	1244	D#5	27	3136	G6	43
523	C4	12	1319	E5	28	3322	G#6	44
554	C#4	13	1397	F5	29	3520	A6	45
587	D4	14	1480	F#5	30	3729	A#6	46
622	D#4	15	1568	G5	31	3951	B6	47

## Owner-Fixed Frequency Single-Tone Beeps

To save programming keystrokes, you can define the frequencies of six single-tone beeps and use their two-digit codes, 48 through 53, in your single-tone beep messages. The default frequencies are shown in the chart below. When you've defined the beeps, write their frequencies in the chart for future reference.

Owner-Fixed Frequency Single-Tone Beeps		
Control Character 9910/9911/9912		
Beep Code	Frequency (Fill In)	Default (Hz)
48		500
49		750
50		1000
51		1250
52		1500
53		1750

To change the frequency of the *Owner-Fixed Frequency Single-Tone Beeps*, use the *Select Frequency of Owner-Fixed Frequency Single-Tone Beeps* command on page 6-28.

## Custom Single-Tone Beeps

*Custom Single-Tone Beeps* allow you to define a beep of any frequency and any duration from 10 ms to 990 ms *on-the-fly*. This flexibility requires 8 characters for each beep.

- Custom single-tone beeps are in the form: 57xxxxyy.
- %xxx+ must be four digits and represents the frequency of the beep as found in the *Tone Code Tables* on pages A-31 and A-33.
- %yy+ must be two digits and represents the duration of the beep in tens of milliseconds.

For example, the custom single-tone beep code for a 1275 Hz beep of 70 ms duration would be 57 0203 07.

## Custom Beep Delay

Duration for *Custom Beep Delays* is defined *on-the-fly*.

- A 4-digit character, 58xx, defines the custom delay.
- The two digits following the 58, shown as xx, represent the duration of the delay in tens of milliseconds.

Although custom delays can be placed anywhere in a single-tone beep message, they go well with custom single-tone beeps if you need to create a truly unique or specialized signalling burst. For example, a string of custom beeps and custom delays could be used to generate a string of ASCII characters of the proper tones for use with modems.

## Single-Tone Beep Gap Change Characters

*Single-Tone Beep Gap Change Characters* are used to introduce a silent period between single-tone beeps. Ten (10) such characters have been defined from 10 ms to 320 ms using the codes 60-69. Single-tone beep gap change characters may be used alone to separate groups of single-tone beeps, or can be automatically placed after every single-tone beep by using the *Automatic Beep Gap ON Character* (described on page 6-26). This parameter reverts to the default at the end of the beep message.

The following table shows *Single-Tone Beep Gap Change* control characters:

Single-Tone Beep Gap Change Characters	
Control Character 9910/9911/9912	
Beep Gap (ms)	Code
10	60
20 (default)	61
30	62
40	63
60	64
80	65
120	66
160	67
240	68
320	69

**Note:** Any time a single-tone beep gap change character is entered, its duration is remembered by the message handler. When the automatic beep gap ON character is encountered, the message handler will use the duration that it remembered from the previous single-tone beep gap change character it found within the message, or the default if none was found. This is also true of the custom single-tone beep delay character.

## Single-Tone Beep Duration Change Characters

*Single-Tone Beep Duration Change* characters are used to set the duration of the beep characters that follow. Ten (10) beep duration change characters have been defined from 10 ms to 320 ms using the codes 70. 79. The beep duration may be changed as often as desired within a single-tone beep message (even between each beep). This parameter reverts to the default at the end of the single-tone beep message.

The following table shows *Beep Duration Change Characters*:

Single-Tone Beep Duration Change Characters	
Control Character 9910/9911/9912	
Beep Duration (ms)	Code
10	70
20	71
30	72
40	73
60 (default)	74
80	75
120	76
160	77
240	78
320	79

---

**Note:** Any time a single-tone beep duration change is made (including a custom single-tone beep), the duration will be remembered by the message handler until the end of the message. When any succeeding single-tone beep is encountered, the message handler will use the duration that it remembered from the previous single-tone beep duration change. At the end of the single-tone beep message, the single-tone beep durations reverts to the default.

---



**Automatic Beep Gap ON Character**

The *Automatic Beep Gap ON Character*, 56, causes the message handler to place a gap between each beep. The duration of the gap depends on that last gap that was encountered within the message. It defaults to 20 ms upon a cold start and can be changed with the *Select Default Beep and Gap Durations* command on page 6-29.

**Automatic Beep Gap OFF Character**

The *Automatic Beep Gap OFF Character*, 55, causes the message handler to send the beeps that follow in a series without any gaps between them. The automatic beep gap defaults to off.

## Select Frequency of Owner-Fixed Frequency Single-Tone Beeps

Changes the frequency (pitch) of the tones.

- Enter the password, followed by the 4-digit root number shown, followed by the 4-digit tone code for your desired frequency.
- The tone code is taken from the *Tone Code Tables* on pages A-31 and A-33. Do not omit leading zeroes.
- The frequency range is 300 Hz to 3 kHz.

### Command Form:

Command	Form	Data Digits
Select Frequency of Single-Tone Beep 48	(PW) 06 01 xxxx *	Tone Code Tables
Select Frequency of Single-Tone Beep 49	(PW) 06 02 xxxx *	
Select Frequency of Single-Tone Beep 50	(PW) 06 03 xxxx *	
Select Frequency of Single-Tone Beep 51	(PW) 06 04 xxxx *	
Select Frequency of Single-Tone Beep 52	(PW) 06 05 xxxx *	
Select Frequency of Single-Tone Beep 53	(PW) 06 06 xxxx *	

**Acknowledgment: Sends OK**

### Errors:

Error	Meaning
? err 1	wrong number of digits entered
? err 2	illegal code entered

### Default Condition:

Command	Default Freq (Hz)	Tone Code
Select Frequency of Single-Tone Beep 48	500	0048
Select Frequency of Single-Tone Beep 49	750	0098
Select Frequency of Single-Tone Beep 50	1000	0148
Select Frequency of Single-Tone Beep 51	1250	0198
Select Frequency of Single-Tone Beep 52	1500	0248
Select Frequency of Single-Tone Beep 53	1750	0298

### Examples:

Let's change the frequency of single-tone beep 48 to 600 Hz. The tone code for 600 Hz is 0068. The command is:

```
(PW) 06 01 0068 *
```

---



---

## Select Default Beep and Gap Durations

**Changes the default beep durations and beep gap durations for single-tone beeps and dual-tone beeps.**

- Enter the password, followed by the 4-digit root number shown, followed by the 1- or 2-digit duration.

---



---

### Command Form:

Command	Form	Data Digits
Select Default Beep Duration for TX1	(PW) 08 00 xx *	01-99 = 10 ms-990 ms
Select Default Beep Gap Duration for TX1	(PW) 08 01 xx *	00-99 = 0 ms-990 ms
Select Default Beep Duration for TX2	(PW) 08 04 xx *	01-99 = 10 ms-990 ms
Select Default Beep Gap Duration for TX2	(PW) 08 05 xx *	00-99 = 0 ms-990 ms
Select Default Beep Duration for TX3	(PW) 08 08 xx *	01-99 = 10 ms-990 ms
Select Default Beep Gap Duration for TX3	(PW) 08 09 xx *	00-99 = 0 ms-990 ms

**Acknowledgment: Sends OK**

### Errors:

Error	Meaning
? err 1	wrong number of digits entered
? err 2	illegal code entered

**Default Condition:** Beep Duration is 60 ms; Beep Gap Duration is 20 ms.

### Examples:

For Transmitter 2, let's change the default Beep Duration to 120 ms (12 x 10-ms = 120 ms) and the default Beep Gap Duration to 40 ms (4 x 10-ms = 40 ms). The commands are:

```
(PW) 08 04 12 *
```

```
(PW) 08 05 4 *
```

---



---

## Enable/Disable Beep Gap Default

Enables or disables the Beep Gap as the default for all single-tone beep and dual-tone beep messages sent to a transmitter.

- Enter the password, the 2-digit root number, the 4-digit software switch number, and one digit, 0 for OFF (disabled), 1 for ON (enabled).

---



---

### Command Form:

Command	Form	Data Digit
Enable/Disable Beep Gap Default for Tx1	(PW) 63 0116 x *	0 = OFF (disabled) 1 = ON (enabled)
Enable/Disable Beep Gap Default for Tx2	(PW) 63 0216 x *	
Enable/Disable Beep Gap Default for Tx3	(PW) 63 0316 x *	

**Acknowledgment:** Sends *OK* message

### Errors:

Error	Meaning
? err 1	wrong number of digits entered (disable only)
? err 2	illegal digit entered (disable only)

**Default Condition:** Beep Gap is OFF (disabled)

---

## Dual-Tone Beep Messages

### Control Character

The control character 9915 must be entered before the actual dual-tone beep characters when building a dual-tone beep message.

---

**Note:** Any message that does not have a control character will be interpreted as a CW message.

---

### Format

The format for one or more sequential simultaneous dual-tone beep messages is as follows:

- Enter the control character 9915, 9916, or 9917.
- Then enter the various dual-tone beep character codes described in the dual-tone beep character tables that follow in this section to create the desired message.
- You may end the dual-tone beep message with the (\*) character, or enter another control character, e.g. 99xx, and continue with another message type.

### Primary/Secondary (Interruptable) Dual-Tone Beep Messages

Dual-Tone Beep Messages can be defined to be non-interruptable or interruptable.

- A *Dual-Tone Beep Message*, defined with the control character 9915, is not interruptable.
- A *Dual-Tone Beep Primary Message*, defined with a control character of 9916, will cease playback if any path is active to a transmitter associated with the message playback at the time the playback commences, or anytime during the playback.
- A *Dual-Tone Beep Secondary Message*, defined with a control character of 9917, will only play in circumstances when a primary message would not. A secondary message is optional. A primary message defined without a secondary message would immediately stop when interrupted. There would be no replacement message played.

For example, the message following sets the RX1 courtesy tone on TX1 as a primary dual-tone beep message such that any activity on the repeater will cause the courtesy message to be discarded:

```
(PW) 31 0100 9916 16 21 *
```

## Pre-Message Delays

The 7330 has two methods of creating a pre-message delay.

In the first method, you insert a %993 xx+Pause Control Code (see page 6-7) ahead of your message.

The second method makes use of a new timer called the *Transmitter Turn-On Message Delay* (see page 11-5). The timer starts when the PTT is activated, and when it expires, the Message Handler is allowed to proceed. The purpose of the delay is to hold off sending messages until the transmitter comes up to full power and any user's CTCSS decoder has unmuted his local audio. If a transmitter has been keyed beyond the turn-on delay when a message is queued, the message will be sent with no delay (unless the user has programmed one into the message). There are separate *Turn-On Delay* commands for each transmitter, so the controller can handle slow or fast transmitters individually.

## Message Level

The Dual-Tone Beep Message Level may be changed before or during a Dual-Tone Beep message. This feature allows you to draw attention to a certain message (or part of a message).

- Enter 9918 xx ahead of the 9915/9916/9917 Dual-Tone Beep Control Characters.
- The two digits shown as %xx+represent the temporary message level and are taken from the *Message Levels* table on page 6-10.
- The message level may be changed as often as desired.

The temporary message level will stay in effect until either changed by other control codes, or until the Dual-Tone Beep message ends.

If you wish to change the Dual-Tone Beep Message Level for all Dual-Tone Beep messages, see the *Set Default Dual-Tone Beep Level* command on page 6-11.

## Dual-Tone Beep Parameters

The following table shows the general parameters related to dual-tone beep messages. These parameters will be discussed in more detail in the sections which follow:

Dual-Tone Beep Parameters	
Control Character 9915/9916/9917	
Beep Parameter	Code
custom dual-tone beep	57xxxxyyyyzz
custom beep delay	58xx
automatic beep gap OFF (default)	55
automatic beep gap ON	56

## Fixed-Frequency Beeps

Forty-eight (48) beeps have been defined in frequency but have variable duration. These beeps are programmed with the character codes 00. 47 and range from 262 Hz to 3951 Hz. It is best to avoid beeps below 300 Hz and above 3000 Hz, since most radio systems are designed for 300. 3000 Hz response.

The following table shows the *Fixed Frequency Beeps*:

Factory-Fixed Frequency Beeps								
Control Character 9915/9916/9917								
Freq (Hz)	Note	Beep	Freq (Hz)	Note	Beep	Freq (Hz)	Note	Beep
262	C3	00	659	E4	16	1661	G#5	32
277	C#3	01	698	F4	17	1760	A5	33
294	D3	02	740	F#4	18	1865	A#5	34
311	D#3	03	784	G4	19	1976	B5	35
330	E3	04	831	G#4	20	2093	C6	36
349	F3	05	880	A4	21	2217	C#6	37
370	F#3	06	932	A#4	22	2349	D6	38
392	G3	07	988	B4	23	2489	D#6	39
415	G#3	08	1046	C5	24	2637	E6	40
440	A3	09	1109	C#5	25	2794	F6	41
466	A#3	10	1175	D5	26	2960	F#6	42
494	B3	11	1244	D#5	27	3136	G6	43
523	C4	12	1319	E5	28	3322	G#6	44
554	C#4	13	1397	F5	29	3520	A6	45
587	D4	14	1480	F#5	30	3729	A#6	46
622	D#4	15	1568	G5	31	3951	B6	47

This table includes associated *note* values for each frequency. However, these note values are simply intended as a guide to the pitch of each beep and should not be construed as musical in nature.

The *Factory Fixed-Frequency Beeps* must be entered in pairs to define the pair of tones generated simultaneously. For example, to generate the dual-tone beep pair of 350 Hz and 440 Hz for the default duration, enter the command:

```
99 15 9915 05 09 *
```

### Custom Dual-Tone Beeps

*Custom Dual-Tone Beeps* are defined *on-the-fly* in both frequency and duration.

- A 12-digit character, *57xxxxyyyyzz*, defines the dual-tone beep.
- The four digits following the 57, shown as *xxxx*, represent the frequency of the higher tone and are taken from the *Tone Code Tables* on pages A-31 and A-33.
- The four digits following the *xxxx*, shown as *yyyy*, represent the frequency of the lower tone and are taken from the *Tone Code Tables* on pages A-31 and A-33.
- The next two digits, shown as *zz*, represent the duration in tens of milliseconds.

Dual-tone beeps allow you to create a unique message with any frequency and any duration to 990 ms. As an example, let's define a dual-tone beep of 350 Hz and 440 Hz for 70 ms. The custom beep code would be

```
57 0018 0038 07.
```

### Custom Beep Delay

Duration for *Custom Beep Delays* is defined *on-the-fly*.

- A 4-digit character, *58xx*, defines the custom delay.
- The two digits following the 58, shown as *xx*, represent the duration of the delay in tens of milliseconds.

Although custom delays can be placed anywhere in a beep message, they go well with custom beeps if you need to create a truly unique or specialized signalling burst.



## Dual-Tone Beep Gap Change Characters

*Dual-Tone Beep Gap Change Characters* are used to introduce a silent period between beeps. Ten (10) such characters have been defined from 10 ms to 320 ms using the codes 60-69. Dual-tone beep gap change characters may be used alone to separate groups of beeps, or can be automatically placed after every beep by using the *Automatic Beep Gap ON Character* (described on page 6-36). This parameter reverts to the default at the end of the beep message.

The following table shows *Beep Gap Change* control characters:

<b>Dual-Tone Beep Gap Change Characters</b>	
Control Character 9915/9916/9917	
Beep Gap (ms)	Code
10	60
20 (default)	61
30	62
40	63
60	64
80	65
120	66
160	67
240	68
320	69

**Note:** Any time a dual-tone beep gap change character is entered, its duration is remembered by the message handler. When the automatic beep gap ON character is encountered, the message handler will use the duration that it remembered from the previous dual-tone beep gap change character it found within the message, or the default if none was found. This is also true of the custom dual-tone beep delay character.

## Dual-Tone Beep Duration Change Characters

*Dual-Tone Beep Duration Change* characters are used to set the duration of the dual-tone beep characters that follow. Ten (10) dual-tone beep duration change characters have been defined from 10 ms to 320 ms using the codes 70-79. The dual-tone beep duration may be changed as often as desired within a dual-tone beep message (even between each pair of beeps). This parameter reverts to the default at the end of the dual-tone beep message.

The following table shows *Dual-Tone Beep Duration Change Characters*:

<b>Dual-Tone Beep Duration Change Characters</b>	
Control Character 9915/9916/9917	
Beep Duration (ms)	Code
10	70
20	71
30	72
40	73
60 (default)	74
80	75
120	76
160	77
240	78
320	79

**Note:** Any time a dual-tone beep duration change is made (including a custom dual-tone beep), the duration will be remembered by the message handler until the end of the message. When any succeeding dual-tone beep is encountered, the message handler will use the duration that it remembered from the previous dual-tone beep duration change. At the end of the dual-tone beep message, the dual-tone beep durations revert to the default.

**Automatic Beep Gap ON Character**

The *Automatic Beep Gap ON Character*, 56, causes the message handler to place a gap between each pair of beeps. The duration of the gap depends on that last gap that was encountered within the message. It defaults to 20 ms upon a cold start and can be changed with the *Select Default Beep and Gap Durations* command on page 6-29.

**Automatic Beep Gap OFF Character**

The *Automatic Beep Gap OFF Character*, 55, causes the message handler to send the pairs of beeps that follow in a series without any gaps between them. The automatic beep gap defaults to off.

---



---

## Enable/Disable No-Gap Hang Workaround

Enables or disables a workaround for a rarely observed hardware limitation that causes tone generation on a port to hang.

- This command inserts a few milliseconds of delay between the dual tones in a tone sequence to allow the hardware to resynchronize properly.
- Enter the password, the 2-digit root number, the 4-digit software switch number, and one digit, 0 for OFF (disabled), 1 for ON (enabled).

---



---

### Command Form:

Command	Form	Data Digit
Enable/Disable No-Gap Hang Workaround	(PW) 63 0005 x *	0 = OFF (disabled) 1 = ON (enabled)

**Acknowledgment:** Sends OK message

### Errors:

Error	Meaning
? err 1	wrong number of digits entered (disable only)
? err 2	illegal digit entered (disable only)

**Default Condition:** No-Gap Hang Workaround is OFF (disabled)

**Explanation:** The 7330 has a rarely seen hardware limitation that is observed during the generation of a sequence of dual tones with no gap between the dual tones. The symptom is that tone generation on a port will stop while speech still works.

To restore tone generation, enter the Controller Power Cycle command (see page 5-29). This is a temporary recovery; the hang will likely occur again.

There are two solutions:

- Add a Beep Gap Change Character (see page 6-35 ) to the beginning of your tone sequence to add a full gap between dual tones, or
- Enter the No Gap Hang Workaround Enable command to add a short gap of a few milliseconds to all dual-tone sequences.

---

## Single Tone Page Messages

### Control Character

The control character 9920 must be entered before the actual page code when building a *Single-Tone Page Message*. If several single-tone pages are to be sent, control character 9920 must be entered before each page code.

### Format

The format for single-tone page message is as follows:

- Enter the control character 9920.
- Enter four digits representing the frequency of the page tone, taken from the *Tone Code Tables* on pages A-31 and A-33.
- Enter two digits representing the duration of the page tone in tenths of seconds.
- The range of duration is 0.1 to 9.9 seconds.
- You may end the message with the (\*) character, or enter another control character, e.g. 99xx, and continue with another message type.

For example, the format of a single-tone page of 1050 Hz of 8.0 seconds (National Weather Service standard page) is 9920 0158 80.

### Pre-Message Delays

The 7330 has two methods of creating a pre-message delay.

In the first method, you can insert a %9993 xx+Pause Control Code (see page 6-7) ahead of your message.

The second method makes use of a new timer called the *Transmitter Turn-On Message Delay* (see page 11-5). The timer starts when the PTT is activated, and when it expires, the Message Handler is allowed to proceed. The purpose of the delay is to hold off sending messages until the transmitter comes up to full power and any user's CTCSS decoder has unmuted his local audio. If a transmitter has been keyed beyond the turn-on delay when a message is queued, the message will be sent with no delay (unless the user has programmed one into the message).

### Inter-Page Delays

An *Inter-Page Delay* is created by the message handler for all tone pages. This delay is inserted immediately after each tone page. This delay defaults to 1.0 second but you may change it with the *Select Inter-Page Delay* command (see page 6-39).

### Message Level

If you wish to change the Single Tone Page Message Level for all Single Tone Page messages, see the *Set Default Single Tone Page Level* command on page 6-11. There are no characters to temporarily change the level.

---



---

## Select Inter-Page Delay

Programs the minimum amount of quiet time after a tone page.

- The *Inter-Page Delay* is the minimum amount of time inserted after a tone page before the *Message Handler* generates any other message.
  - Enter the password, the 2-digit root number, the 4-digit timer number, and 1 to 5 digits, 0-65535 for 0.00 through 655.35 seconds.
- 
- 

### Command Form:

Command	Form	Data Digit
Select TX1 Inter-Page Delay	(PW) 09 0114 xxxxx *	xxxxx = (0-65535) = (0-655.35) seconds
Select TX2 Inter-Page Delay	(PW) 09 0214 xxxxx *	
Select TX3 Inter-Page Delay	(PW) 09 0314 xxxxx *	

**Acknowledgment:** Sends *OK* message

### Errors:

Error	Meaning
? err 1	wrong number of digits entered
? err 2	invalid timer or seconds parameter

**Default Condition:** *Inter-Page Delay* is 1.00 second.

### Example:

To set the Transmitter 1 Inter-Page Delay to 2.00 seconds, enter the command:

```
(PW) 09 0114 200 *
```

## Two-Tone Sequential Page Messages

### Control Character

The control character 9930 must be entered before the actual page code when building a *Two-Tone Sequential Page Message*. If several two-tone pages are to be sent, the control character 9930 must be entered before each two-tone page code.

### Format

Two-tone pages are sometimes referred to as a %*n*+1+format (one tone followed by one tone). The format for two-tone sequential page messages is as follows:

- Enter the control character 9930.
- Enter four digits representing the frequency of the first tone, taken from the *Tone Code Tables* on pages A-31 and A-33.
- Enter two digits representing the duration of the first tone in tenths of seconds. The range of duration is 0.1 to 9.9 seconds.
- Enter four digits representing the frequency of the second tone, taken from the *Tone Code Tables*.
- Enter two digits representing the duration of the second tone in tenths of seconds.
- The range of duration is 0.1 to 9.9 seconds.
- You may end the message with the (\*) character, or enter another control character, e.g. 99xx, and continue with another message type.

For example, the format of a two-tone sequential page of 349.0 Hz for 1.0 seconds followed by 433.7 Hz for 3.0 seconds is

```
9930 0018 10 0035 30.
```

### Pre-Message Delays

The 7330 has two methods of creating a pre-message delay.

In the first method, you can insert a %993 xx+Pause Control Code (see page 6-7) ahead of your message.

The second method makes use of a new timer called the *Transmitter Turn-On Message Delay* (see page 11-5). The timer starts when the PTT is activated, and when it expires, the Message Handler is allowed to proceed. The purpose of the delay is to hold off sending messages until the transmitter comes up to full power and any user's CTCSS decoder has unmuted his local audio. If a transmitter has been keyed beyond the turn-on delay when a message is queued, the message will be sent with no delay (unless the user has programmed one into the message).

### **Inter-Page Delays**

An *Inter-Page Delay* is created by the message handler for all tone pages. This delay is inserted immediately after each tone page. This delay defaults to 1.0 second but you may change it with the *Select Inter-Page Delay* command (see page 6-39).

### **Message Level**

If you wish to change the Two-Tone Page Message Level for all Two-Tone Page messages, see the *Set Default Two-Tone Page Level* command on page 6-11. There are no characters to temporarily change the level.



## Five/Six-Tone Page Messages

### Control Character

The control character 9940 must be entered before the actual page code when building a *5/6-Tone Page Message*. If several 5/6-tone pages are to be sent, control character 9940 must be entered before each 5/6-tone page code.

### Format

The format for five/six-tone page messages is as follows:

- Enter the control character, 9940.
- Enter the preamble digit (0-9), followed by the five digits (0-9), followed by 1 if you wish to send the *X (dual address)* tone, or 0 if you do not wish to send the *X* tone.
- You may end the message with the (\*) character.
- If you wish to enter another control character, e.g. 99xx, and continue with another message type, you must add another digit to the end of the 5/6-tone page. This is required because the normal format results in an odd number of characters (11), and the message handler requires even numbers of characters in each message.

For example, the format of the 5/6-tone page *1-13657X* is 99401136571. If no *X* tone is desired, the format is 99401136570. If this page were to be sent twice in the same message, a *bogus* digit would be added at the end of the first page to restore evenness to the command. The format would be 99401136571 0 99401136571. (Once again, the space is shown for clarity.)

---

**Note:** The message handler *always* requires a preamble digit. It will automatically substitute the *R* tone for a repeated digit.

---

### Pre-Message Delays

The 7330 has two methods of creating a pre-message delay.

In the first method, you can insert a ~~99~~993 xx+Pause Control Code (see page 6-7) ahead of your message. The second method makes use of a timer called the *Transmitter Turn-On Message Delay* (see page 11-5).

### Inter-Page Delays

An *Inter-Page Delay* is created by the message handler for all tone pages. This delay is inserted immediately after each tone page. This delay defaults to 1.0 second but you may change it with the *Select Inter-Page Delay* command (see page 6-37).

### **Message Level**

If you wish to change the Five/Six-Tone Page Message Level for all Five/Six-Tone Page messages, see the *Set Default Five/Six-Tone Page Level* command on page 6-9. There are no characters to temporarily change the level.

## DTMF Page Messages

### Control Character

The control character 9950 must be entered before the actual DTMF character codes when building a *DTMF Page Message*. (Remember, if a Message does not begin with a control character, the message handler will assume the message should be sent in CW!)

### Format

The format for DTMF page message is as follows:

- Enter the control character 9950.
- Then enter the various DTMF character codes described in the *DTMF Character Set Tables* below to create the desired message/page.
- You may end the DTMF message with the (\*) character, or enter another control character, e.g. 99xx, and continue with another page type.

### Pre-Message Delays

The 7330 has two methods of creating a pre-message delay. In the first method, you can insert a ~~9993~~ 9993 xx+Pause Control Code (see page 6-7) ahead of your message. The second method makes use of a new timer called the *Transmitter Turn-On Message Delay* (see page 11-5) delays the message until the transmitter is at full power and any user's CTCSS decoder has unscelched his radio.

### Inter-Page Delays

An *Inter-Page Delay* is created by the message handler for all tone pages. This delay is inserted immediately after each DTMF page. This delay defaults to 1.0 second but you may change it with the *Select Inter-Page Delay* command (see page 6-39). If desired, a DTMF page can consist of several DTMF digits, a pause, more DTMF digits, and so on. This feature allows you to place a series of DTMF pages within one message.

### Message Level

If you wish to change DTMF Page Message Level for all DTMF Page messages, see the *Set Default DTMF Page Level* command on page 6-11. There are no characters to temporarily change the level.

### Defaults

Until changed by the codes which follow, the DTMF tone duration is 100 ms and the gap between DTMF characters is 100 ms.

## DTMF Characters

There are 16 *DTMF Characters*: numerals 0 through 9, letters A through D, and the symbols (\*) and (#). Each character has a two-digit code, shown in the *DTMF Characters Table* which follows. Enter the appropriate two-digit code for each DTMF character that you wish to send.

The following table shows *DTMF Characters* and their related control characters (codes):

DTMF Characters			
Control Character 9950			
DTMF Character	Code	DTMF Character	Code
0	00	8	08
1	01	9	09
2	02	A	10
3	03	B	11
4	04	C	12
5	05	D	13
6	06	*	14
7	07	#	15

## DTMF Duration Change Characters

*DTMF Duration Change Characters* are used to set the duration of the DTMF characters that follow. Ten (10) DTMF duration change characters have been defined from 30 ms to 200 ms using the codes 20-29. The DTMF Duration may be changed as often as desired within a DTMF message. This parameter reverts to the default at the end of the DTMF message.

The following table shows *DTMF Duration Change Characters*:

DTMF Duration Change Characters	
Control Character 9950	
DTMF Duration (ms)	Code
30	20
40	21
50	22
60	23
70	24
80	25
90	26
100 (default)	27
150	28
200	29

## DTMF Custom Duration Change Characters

The easiest way to change the duration of the DTMF characters is to use the 2-digit codes mentioned above. However, you may require other durations, so the controller allows you to choose a *Custom DTMF Duration Change*. This parameter may be set from 10 ms to 9900 ms (9.9seconds).

- Use the code %50xx,+ where xx is a number from 01 to 99, to get durations from 10 ms to 990 ms.
- Use the code %61xx,+ where xx is a number from 01 to 99 to get durations from 100 ms to 9900 ms.

Once you change the duration, it will stay at the new value until the end of the DTMF message.

## DTMF Gap Change Characters

Every DTMF character sent by the controller is followed by a *DTMF Gap*, or silent period. You may wish to change the duration of the DTMF characters from the default duration of 100 ms. Ten of the most common durations are shown in the *DTMF Gap Change Characters Table*. If you wish to change the gap to one of the values shown, enter the two-digit code corresponding to your choice. If the gap you want is not in the table, go to the custom DTMF gap change description immediately below. Once you change the duration, it will stay at the new value until the end of the DTMF message.

The following table shows *DTMF Gap Change Characters*:

DTMF Gap Change Characters	
Control Character 9950	
DTMF Gap (ms)	Code
20	30
30	31
40	32
50	33
60	34
70	35
80	36
90	37
100 (default)	38
150	39

## DTMF Custom Gap Change Characters

The easiest way to change the duration of the gap is to use the 2-digit codes mentioned above. However, you may require other gap durations, so the controller allows you to choose a *Custom DTMF Gap Change*. Duration of the gap may be set from 10 ms to 9900 ms (9.9seconds).

- Use the code %2xx,+ where xx is a number from 01 to 99, to get durations from 10 ms to 990 ms.
- Use the code %3xx,+ where xx is a number from 01 to 99 to get durations from 100 ms to 9900 ms.

Once you change the DTMF gap, it will stay at the new value until the end of the DTMF message.

---

**Note:** If you intend to program a large number of DTMF pages with varying tone durations and gaps, it would be a good idea to set up the proper duration values at the beginning of each individual page. Otherwise, the defaults will be used for the new page.

---

## DTMF Pause Characters

Unlike a DTMF gap, which is automatically sent after each DTMF character, a *DTMF Pause Character* may be inserted anywhere in a DTMF page. These pauses are typically used to separate individual pages within a multi-page message. Ten common pause durations are shown in the *DTMF Pause Characters Table*. If you wish to insert a pause into a page, enter the two-digit code corresponding to your choice.

If the DTMF Pause you want is not in the table, go to the *Custom DTMF Pause* description below.

The following table shows *DTMF Pause Characters*:

DTMF Pause Characters	
Control Character 9950	
DTMF Pause (ms)	Code
100	40
200	41
300	42
400	43
500	44
600	45
700	46
800	47
900	48
1000	49

## DTMF Custom Pause Characters

The easiest way to insert a pause is to use the 2-digit codes mentioned above. However, you may require other pauses, so the controller allows you to choose a *Custom DTMF Pause*. Duration may be set from 10 ms to 9900 ms (9.9seconds).

- Use the code %4xx,+ where xx is a number from 01 to 99, to get durations from 10 ms to 990 ms.
- Use the code %5xx,+ where xx is a number from 01 to 99 to get durations from 100 ms to 9900 ms.

**Note:** Since each DTMF character is followed by a DTMF gap, be sure to add the DTMF gap duration to the DTMF pause duration if you want an accurate idea of the time between two DTMF pages.

Pauses are additive. A long pause may be created by placing a series of pauses together within the DTMF page.

## DTMF Custom Changes (Duration • Gap • Pause)

The following table summarizes *DTMF Custom Changes* affecting duration, gap, and pause. It is generally related to preceding sections.

DTMF Custom Changes (Duration Gap Pause)		
Control Character 9950		
DTMF Custom Change	Code	Data Digit
custom DTMF duration change (10-990 ms)	50xx	01-99 x 10 ms
custom DTMF duration change (100-9900 ms)	51xx	01-99 x 100 ms
custom DTMF gap change (10-990 ms)	52xx	01-99 x 10 ms
custom DTMF gap change (100-9900 ms)	53xx	01-99 x 100 ms
custom DTMF pause (10-990 ms)	54xx	01-99 x 10 ms
custom DTMF pause (100-9900 ms)	55xx	01-99 x 100 ms
to ignore each custom DTMF change code		enter 00 for xx in any of above codes

## DTMF Character Set Tables Explained

The preceding section is somewhat complicated. Therefore, in an effort to clarify some of the main points, the following explanation is given.

**Format.** The page may begin with a delay if the transmitter was just keyed or if there was another page just before this one. When the page is finished, an *Inter-Page Delay* occurs. If desired, a DTMF page can consist of several DTMF digits, a pause, some more digits, a pause, and so on. This allows a series of pages all contained in one message.

**Defaults.** Until changed by one of the above codes, the DTMF digit duration is 100 ms and the gap between digits is 100 ms. Once a DTMF duration change or a DTMF gap change is made, it remains in effect until the end of the message or until changed by another code within the same message. If the user expects to require DTMF pages of varying durations and gaps, it would be wise to set up the proper DTMF duration change and DTMF gap change codes at the beginning of each page.

**DTMF Custom Changes.** *DTMF Custom Changes* allow the user to choose durations, gaps, and pauses which are not listed in the various tables above. These DTMF Custom Changes are found in their own table labeled *%DTMF Custom Changes (Duration • Gap • Pause)* on page 6-48. The advantages in using codes from the regular tables (*not* the *DTMF Custom Changes Table*) is that such codes require only two keystrokes. DTMF Custom changes are more flexible, but require four keystrokes. If 00 is entered for xx, the DTMF custom change will be ignored.

**DTMF Pauses.** Pauses are additive. Therefore, a series of *DTMF Pause Characters* adds to the total DTMF pause.

**Each DTMF digit is always followed by a DTMF Gap.** Therefore, the duration of a *DTMF Gap Change Character* adds to the duration of a *DTMF Pause Character* when calculating the delay between the last digit of one page and the first digit of the next page.

### Examples

To generate a simple page of the DTMF characters %0, 2, 3, A, B, C+ at the default durations of 100 ms and the default DTMF gap of 100 ms, you would enter this:

```
(PW) 15 9950 01 02 03 10 11 12 *
```

To send the same characters, but with a duration of 50 ms and a gap width of 50 ms, you would enter this:

```
(PW) 15 9950 22 33 01 02 03 10 11 12 *
```

---



You can change the durations and gaps anywhere in the message. Here is a page with 1, 2, 3 sent at 50 ms/50 ms and A, B, C sent at 150 ms/100 ms with a 1-second pause between the two pages:

```
(PW) 15 9950 22 33 01 02 03 49 28 38 10 11 12 *
```

---

**Note:** The digit duration reverts to the defaults of 100 ms duration and 100 ms gap at the end of the message.

---

You can use DTMF custom duration change characters and DTMF custom gap characters if you have special requirements. In this example, we will generate two pages. The first will be %1, 2, 3+ at 160 ms/110 ms. Then we will have a 5-second pause, followed by %A, B, C+ at 300 ms/120 ms

```
(PW) 15 9950 5016 5211 01 02 03 5550 5030 5212 10 11 12 *
```

Here's the explanation: 9950 = control character to generate a DTMF Page; 5016 = DTMF custom duration change, 16 x 10 ms = 160 ms; 5211 = DTMF custom gap change, 11 x 10 ms = 110 ms; 5550 = DTMF custom pause change, 10 x 100 ms = 5 seconds; 5030 = DTMF custom duration change, 30 x 10 ms = 300 ms; and 5212 = DTMF custom gap change, 12 x 10 ms = 120 ms.

---



---

## Select Default DTMF Durations

**Changes the default DTMF durations and DTMF gap durations.**

- Enter the password, followed by the 4-digit root number shown, followed by the 1- or 2-digit duration.
- 
- 

### Command Form:

Command	Form	Data Digits
Select Default DTMF Duration for TX1	(PW) 08 02 xx *	01-99 = 10 ms-990 ms
Select Default DTMF Gap Duration for TX1	(PW) 08 03 xx *	
Select Default DTMF Duration for TX2	(PW) 08 06 xx *	
Select Default DTMF Gap Duration for TX2	(PW) 08 07 xx *	
Select Default DTMF Duration for TX3	(PW) 08 10 xx *	
Select Default DTMF Gap Duration for TX3	(PW) 08 11 xx *	

**Acknowledgment: Sends OK**

### Errors:

Error	Meaning
? err 1	wrong number of digits entered
? err 2	illegal code entered

**Default Condition:** DTMF Duration is 100 ms; DTMF Gap Duration is 100 ms.

### Examples:

For Transmitter 1, let's change the default DTMF Duration to 180 ms (18 x 10 ms = 180 ms) and the default DTMF Gap Duration to 120 ms (12 x 10 ms = 120 ms). The commands are:

```
(PW) 08 02 18 *
```

```
(PW) 08 03 12 *
```

## SELCAL Page Messages

### Control Character

The control character 9955 must be entered before the actual page code when building a *SELCAL Page Message*. (Remember, if a Message does not begin with a control character, the message handler will assume the message should be sent in CW!) If several SELCAL pages are to be sent, control character 9955 must exist before each SELCAL page code.

### Format

SELCAL is a tone paging format of two simultaneous tones, a gap, and another two simultaneous tones. This format is sometimes referred to as a %*ww*+2+ format (two tones followed by two tones).

The format for specifying a SELCAL page message is as follows:

- Enter the control character, 9955.
- The format is 8 digits, *wwxyzz*, where %*ww*+ and %*xx*+ make up the first tone pair and %*yy*+ and %*zz*+ make up the second tone pair, two digits per SELCAL character. Enter the 4 2-digit codes from the table below.
- You may end the message with the (\*) character, or enter another control character, e.g. 99xx, and continue with another message type.

For example, the format of a particular SELCAL page *ARBS* is 995500140115. The 7330 will send the first tone pair for 1.25 seconds, pause 0.2 seconds, then send the second tone pair for 1.0 second.

SELCAL Characters		
Designation	Frequency (Hz)	Digit Code
Red A	312.6	00
Red B	346.7	01
Red C	384.6	02
Red D	426.6	03
Red E	473.2	04
Red F	524.8	05
Red G	582.1	06
Red H	645.7	07
Red J	716.1	08
Red K	794.3	09
Red L	881	10
Red M	977.2	11
Red P	1083.9	12
Red Q	1202.3	13
Red R	1333.5	14
Red S	1479.1	15

### **Pre-Message Delays**

The 7330 has two methods of creating a pre-message delay.

In the first method, you can insert a %993 xx+Pause Control Code (see page 6-7) ahead of your message. The second method makes use of a new timer called the *Transmitter Turn-On Message Delay* (see page 11-5).

### **Inter-Page Delays**

An *Inter-Page Delay* is created by the message handler for all tone pages. This delay is inserted immediately after each tone page. This delay defaults to 1.0 second but you may change it with the *Select Inter-Page Delay* command (see page 6-39). If desired, a SELCAL page can consist of a SELCAL page message, a pause, another SELCAL page message, and so on. This feature allows you to place a series of SELCAL pages within one message.

### **Message Level**

If you wish to change the SELCAL Page Message Level for all SELCAL Page messages, see the *Set Default SELCAL Page Level* command on page 6-11. There are no characters to temporarily change the level.

## Speech Messages

### Control Character

The control character 9960 must be entered before the actual speech word codes when building a message.

### Format

The format for *Speech Messages* is as follows:

- Enter the control character 9960, 9961, or 9962.
- Enter the various standard vocabulary speech word codes described in the *Standard Speech Vocabulary Tables* beginning on page A-17 to create the desired message.
- Or, enter the various custom word codes you built into a *Custom Audio Library*. (See Chapter 23, *Custom Audio Library*.)
- Each speech word is represented by a four-digit code. Do not omit leading zeroes.
- You may end the message with the (\*) character, or enter another control character, e.g. 99xx, and continue with another message type.

For example, this identifier message would speak %WA1XYZ Repeater+

```
(PW) 31 0110 9960 0069 0045 0001 0068 0069 0070 0342 *
```

### Primary/Secondary (Interruptable) Speech Messages

Speech messages can be defined to be non-interruptable or interruptable.

- A *Speech Message*, defined with the control character 9960, is not interruptable.
- A *Speech Primary Message*, defined with a control character of 9961, will cease playback if any path is active to a transmitter associated with the message playback at the time the playback commences, or anytime during the playback.
- A *Speech Secondary Message*, defined with a control character of 9962, will only play in circumstances when a primary message would not. A secondary message is optional. A primary message defined without a secondary message would immediately stop when interrupted. There would be no replacement message played.

For example, this identifier message would speak %WA1XYZ Repeater+, but if a receiver became active, the message would revert to %WA1XYZ+in CW:

```
(PW) 31 0110 9961 0067 0045 0001 0068 0069 0070 0342
9902 32 10 01 33 34 35 *
```

## Pre-Message Delays

The 7330 has two methods of creating a pre-message delay.

In the first method, you insert a %993 xx+Pause Control Code (see page 6-7) ahead of your message. The second method makes use of a new timer called the *Transmitter Turn-On Message Delay* (see page 11-5).

## Intra-Message Delay

A delay can be inserted anywhere within a message that a word code can be used. Two delay ranges are available.

- Use the code %0xx,+where xx is a number from 00 to 99, to get durations from 0 ms to 990 ms.
- Use the code %1xx,+where xx is a number from 00 to 99 to get durations from 0 ms to 9900 ms.

## Message Level

The speech message playback level may be changed before or during a message. This feature allows you to draw attention to a certain message (or part of a message).

- Enter 9963 xx ahead of the 9960/9961/9962 Speech Control Characters.
- The two digits shown as %xx+represent the temporary message level and are taken from the *Message Levels* table on page 6-10.
- The level may be changed as often as desired.

The temporary message level will stay in effect until either changed by other control codes, or until the Speech message ends.

If you wish to change the level for all Speech messages, see the *Set Default Speech Playback Level* command on page 6-11.

## Speech Vocabulary

Speech messages utilize the *Standard Speech Vocabulary Tables* beginning on page A-17 and also words contained within your *Custom Audio Library*. See Chapter 23, Custom Audio Library, for details on adding your own sounds, words, and phrases to the controller.

When no library is loaded in the controller's flash, or the word code is not included in the standard or custom speech library, the controller skips the word code.

## Tone Codes

When entering tone frequencies for CW, beep, or paging messages, a *Tone Code* is required. Tone Codes are 4-digit numbers representing a particular entry in the *Tone Code Tables*.

### Tone Code Table Explained

The general *Tone Code Table* was created to simplify your programming efforts by listing frequencies from 260 Hz to 3 kHz (in 5 Hz increments), and the appropriate tone code for each frequency. The complete general *Tone Code Table* begins on page A-31 and looks similar to this:

Tone Code Table											
Freq	Code	Freq	Code	Freq	Code	Freq	Code	Freq	Code	Freq	Code
260	0000	460	0040	660	0080	860	0120	1060	0160	1260	0200
265	0001	465	0041	665	0081	865	0121	1065	0161	1265	0201
270	0002	470	0042	670	0082	870	0122	1070	0162	1270	0202
275	0003	475	0043	675	0083	875	0123	1075	0163	1275	0203
280	0004	480	0044	680	0084	880	0124	1080	0164	1280	0204
285	0005	485	0045	685	0085	885	0125	1085	0165	1285	0205
290	0006	490	0046	690	0086	890	0126	1090	0166	1290	0206

**Note:** Most radio systems have a response of 300 Hz to 3 kHz, and will not pass tone frequencies outside this range.

### Calculating Tone Codes

A simple formula is defined to access the correct tone code entry in the table:

$$\text{ToneCode} = ((\text{frequency} - 260) / 5)$$

### Plectron Tone Code Table

A separate tone code table is shown on page A-33 that lists each of the tones used for Plectron two-tone pages.

## Run-Time Variables

*Run-Time Variables* (RTV) are small code groups that you place into a message to be expanded at *%un time+* (the instant the message is actually transmitted by the controller). The message handler recognizes run-time variables because they always begin with 98.

When the message handler encounters an RTV, it forms the appropriate message and transmits it in place of the RTV code. You could, for example, announce the time or date as part of an ID or other occasion or speak the voltage of a backup battery. You may precede and/or follow the RTV with other messages, routing codes, and so on. RTVs may be placed in succession to form a single expression.

### Clock and Calendar RTVs

You can build messages that say the day, date, and time in various formats and order.

Clock and Calendar RTVs			
Run-Time Variable	Meaning	Format	Example
9810	Hour & Minute, 12-hr format	CW	2 45
9811	AM/PM	CW	PM
9812	Hour & Minute, 24-hr format	CW	14 45
9813	Day of Week	CW	WED
9814	Month	CW	JAN
9815	Day of Month	CW	1
9816	Seconds	CW	27 in CW
9820	Hour & Minute, 12-hr format	Speech	Two forty-five
9821	AM/PM	Speech	PM
9823	same as 9824 without <i>%hours+</i> & <i>%minutes+</i> ; uses <i>%zero+</i>	Speech	Fourteen zero-five
9824	Hour & Minute, 24-hr format	Speech	14 hours, 45 minutes
9825	same as 9824 without <i>%hours+</i> & <i>%minutes+</i> ; uses <i>%h+</i>	Speech	Fourteen oh-five
9826	Day of Week	Speech	Wednesday
9827	Cardinal Day-of-Month	Speech	One
9828	Ordinal Day-of-Month	Speech	First
9829	Month	Speech	January
9831	<i>%morning, afternoon, evening+</i>	Speech	Afternoon
9832	Seconds	Speech	Twenty-seven
9833	Year	Speech	Twenty seventeen
9834	Year	Speech	Two thousand seventeen



A feature of the clock and calendar RTVs is that the current time and date are read and stored at the first RTV encountered in a message. If the time or date rolls over during the message transmission, it will not affect the time or date being sent.

### Clock and Calendar Notes:

- 9820, which is a spoken 12-hour time RTV, will say `%clock` on the hour (xx:00). Midnight to 11:59 = AM
- 9827 is used with the month outside the U.S., as in this example: `%One January`. 9828 is used with the month inside the U.S., as in this example: `%January First`.
- 9831 switches from `%afternoon` to `%evening` at 6:00 PM (18:00)
- The real-time clock and calendar features leap-year correction.
- 9816 and 9832, seconds in CW or speech, can be used to accurately set the clock. (See *Chapter 21, Clock and Calendar*.)

### Examples:

Here are some ideas: To send the time and AM or PM in voice, enter

```
(PW) 15 9820 9821 *
```

You would hear `%two forty-five PM` or something similar.

To say `%the time is ( )`, enter

```
(PW) 15 9960 0357 0091 0287 9820 9821 *
```

9960 is the control character for speech.

You can create similar commands to send `%today is ( )`, `%the date is ( )`, `%the next VE test is ( )`, and so on. Dumping the IRLP node could announce `%all complete at ( )`. The ID could include `%is (Monday) (morning) on W0XYZ repeater`.

---

**Note:** It is not necessary to place the control code 9900 in front of CW run-time variables or the control code 9960 in front of voice run-time variables. The RTV automatically inserts these control codes into the message. However, you must enter control codes *after* the RTV if you have a different type of message to follow.

---

## Datatype RTVs

With Datatype RTVs, you can build messages that say the battery voltage is 13.2 volts, floor number 3 is open, and so on.

Datatype RTVs accept a list of parameters to select a specific value to speak and how to speak it.

Datatype RTVs			
Run-Time Variable	Meaning	Format	Example
9840 0pxx [wc0 wc1]	Booleans	Speech	%zero+, %one+
9841 0pxx [wc0 wc1]	Software Switches	Speech	%zero+, %one+
9850 0pxx	Counters	Speech	%wo+
9851 rpxx	Timers	Speech	%one point six five+
9852 xxmm	A-to-D	Speech	%thirteen point two+

### Notes:

- r = range of timer
- p = port number
- xx = value number
- wc0 = wordcode spoken when the value is zero
- wc1 = wordcode spoken when the value is one
- mm = meter face to use when formatting speech

### Booleans:

Use the table of booleans starting on page A-50 to select a boolean number. In the message, specify the boolean to read back. By default, you will hear the controller speak %zero+ or %one+ for the value of the boolean. You can optionally provide the two wordcodes that you want to speak instead of the defaults. Select wordcodes from the Speech Vocabulary Tables starting on page A-17.

To speak the state of Logic Input #1 using the default words:

```
(PW) 15 9840 0013 *
```

You would hear %zero+ or %one+.

To speak the state of Logic Input #1 in words that you specify:

```
(PW) 15 9840 0013 0316 0235 *
```

You would hear %open+ or %closed+.

You can include the RTV in a complete message that might say floor number three is open:+

---

(PW) 15 9960 0249 0312 0005 0287 9840 0013 0316 0235 \*

**Software Switches:**

Use the table of software switches starting on page A-46 to select a software switch number. In the message, specify the software switch to read back. By default, you will hear the controller speak ~~%zero+~~ or ~~%one+~~. You can optionally provide the two wordcodes that you want to speak instead. Select wordcodes from the Speech Vocabulary Tables starting on page A-17.

To speak the state of Software Switch 0141, the Path 11 Enable:

(PW) 15 9841 0141 \*

You would hear ~~%zero+~~ or ~~%one+~~.

To speak the state of the Path 11 Enable in words that you specify:

(PW) 15 9841 0141 0248 0255 \*

You would hear ~~%disabled+~~ or ~~%enabled+~~.

**Counters:**

Use the table of counters on page A-49 to select a counter number. In the message, specify the counter to read back.

To speak the current count of the Path 11 End-of-Activity Counter:

(PW) 15 9850 0101 \*

You would hear the count spoken.

**Timers:**

Use the table of timers starting on page A-41 to select a timer number. In the message, specify the timer to read back.

To speak the current value of the TX1 ID Interval Timer:

(PW) 15 9851 2103 \*

You would hear the timer value spoken.

**A-to-D:**

In the message, specify the A-to-D channel to read back, 1 thru 3, as two digits 01, 02, or 03. Also specify the meter face to format the reading, 00 is the unscaled value.

To speak the current raw value of A-to-D channel #3:

```
(PW) 15 9852 03 00 *
```

You would hear the value spoken.

**Miscellaneous RTVs**

You can build messages that say %the version is ( ),+

Miscellaneous RTVs			
Run-Time Variable	Meaning	Format	Example
9899	Software Version	Speech	%three point six point zero+

**Software Version:**

To speak the current firmware version:

```
(PW) 15 9899 *
```

**Note:** It is not necessary to place the control code 9900 in front of CW run-time variables or the control code 9960 in front of voice run-time variables. The RTV automatically inserts these control codes into the message. However, you must enter control codes *after* the RTV if you have a different type of message to follow.

---



---

## Select/Review/Play User Messages

Selects, changes, or reviews general purpose user-defined messages.

- *User Messages* can be used in the *Select Initial and Normal ID Tail Messages* command (see page 12-10.)
- Enter the password, followed by the 4-digit root number shown, followed by the desired message.
- Any message may have any combination of message types, including CW, beeps, page tones, speech, etc.
- The maximum size of any message is 50 bytes (50 2-digit codes).
- You must count the control character. Therefore, any message could have 46 CW characters, 23 speech words, etc.
- To delete a message, enter the password, the 4-digit root number, and the (\*) (do not enter any message).

---



---

### Command Form:

Command	Form
Select User Message #1	(PW) 31 0015 (message) *
Select User Message #2	(PW) 31 0016 (message) *
Select User Message #3	(PW) 31 0017 (message) *
Select User Message #4	(PW) 31 0018 (message) *
Select User Message #5	(PW) 31 0019 (message) *
Select User Message #6	(PW) 31 0020 (message) *
Select User Message #7	(PW) 31 0021 (message) *
Select User Message #8	(PW) 31 0022 (message) *
Select User Message #9	(PW) 31 0023 (message) *
Select User Message #10	(PW) 31 0024 (message) *
Review/Play User Message #1	(PW) 34 0015 *
Review/Play User Message #2	(PW) 34 0016 *
Review/Play User Message #3	(PW) 34 0017 *
Review/Play User Message #4	(PW) 34 0018 *
Review/Play User Message #5	(PW) 34 0019 *
Review/Play User Message #6	(PW) 34 0020 *
Review/Play User Message #7	(PW) 34 0021 *
Review/Play User Message #8	(PW) 34 0022 *
Review/Play User Message #9	(PW) 34 0023 *
Review/Play User Message #10	(PW) 34 0024 *

---

**Acknowledgment:** Sends *OK* message

**Errors:**

Error	Meaning
? err 1	wrong number of digits entered
? err 2	illegal digit entered

**Default Condition:** No message.

---



---

## Send Message

Sends a message when commanded.

Unlike the various *Select Programmable Messages* commands used throughout the controller, this command *does not* store the message in memory. It has two purposes:

- You can experiment with different messages types by entering this command and listening for the results.
- You can place this command into a macro so that a message is sent when the macro is executed.

---



---

### Command Form:

Command	Form
Send Message	(PW) 15 (message) *

**Acknowledgment:** Sends the message

### Errors:

Error	Meaning
? err 1	too many digits entered

**Default:** None

### Example: CW Message

Let's send some CW characters, some single-tone beep characters, then some CW characters again. The CW characters will be A, B, and C; the single-tone beeps will be 25 through 30 at 80 ms durations with 20 ms gaps between them; and the final CW characters will be 1, 2, at 30 WPM and 1000 Hz frequency.

Looking up the *CW Characters Table* beginning on page 6-16, we see that the control character is 9900; A, B, and C are 10 11 12 respectively. Looking up the *Single-Tone Beep Character Set Tables* beginning on page 6-21, we see that the control character is 9910;

- To get 80 ms beep durations, we must enter 75 (from the *Beep Duration Change Characters Table*)
- To get 20 ms gaps we must enter 56 to turn the automatic beep gaps ON (from the *Single-Tone Beep Parameters (General) Table*), and 61 to get 20 ms beep gaps (from the *Single-Tone Beep Gap Change Characters Table*).

Going to the *CW Frequency Change and Speed Change Tables* on page 6-17, we see that the control character is 9900 again. To get 30 WPM we must enter:

```
68
```

To get 1000 Hz frequency, we must enter:

```
590148
```

and 1, 2, 3 is:

```
01 02 03
```

Therefore, our complete command to send this message is:

```
(PW) 15 9900 101112 9910 755661252627282930 9900 6591000010203*
```

You may never have a need for a message like this, but this example shows the flexibility available in the controller.

### **Example: Speech Message**

Let's speak power up reset version + and the software version number. To do this, look up the word codes in the *Speech Vocabulary Table* (see page A-19) and the software version RTV in the *Run-Time Variable* table (see page A-29). The resulting message looks like this:

```
9960 0148 0368 1293 9899
```

And the command to send this message looks like this:

```
(PW) 15 9960 0148 0368 1293 9899 *
```

The command to program this message as the *Warm Reset Message* (see page 6-65) is:

```
(PW) 31 0000 9960 0148 0368 1293 9899 *
```



---

---

## Copy Message

Copies the contents of a message from one message number to another.

- Enter the password, followed by the 2-digit root number shown, the 4-digit source message number (yyyy) and the 4-digit destination message number (zzzz).

---

---

### Command Form:

Command	Form
Copy Message	(PW) 13 yyyy zzzz *

**Acknowledgment:** Sends *OK* message

### Errors:

Error	Meaning
? err 1	too many digits entered
? err 2	illegal digit entered

**Default:** None

---



---

## Select/Review Warm Reset Message

Selects, changes, or reviews the warm reset message.

- Enter the password, the 2-digit root number shown, the 4-digit message number (0000), followed by the desired message.
  - Any message may have any combination of message types, including CW, beeps, page tones, speech, etc.
  - The maximum size of any message is 50 bytes (50 2-digit codes).
  - You must count the control character. Therefore, any message could have 46 CW characters, 23 speech words, etc.
  - To delete a message, enter the password, the 2-digit root number, the 4-digit message number (0000), and the (\*) (do not enter any message).
- 
- 

### Command Form:

Command	Form	Default
Select Warm Reset Message	(PW) 31 0000 (message) *	See below
Review Warm Reset Message	(PW) 34 0000 *	none

**Acknowledgment:** Sends *OK* message

### Errors:

Error	Meaning
? err 1	wrong number of digits entered
? err 2	illegal digit entered

**Default Condition:** Sends %~~S~~-COM 7330 Version *version number*+in speech to TX1.

---



---

## Stop a Speech Message In Progress

Stops a currently playing speech message.

- Skips the rest of the currently playing speech.
- If no transmitters are specified, the message playing on the port where this command was entered is stopped.
- Enter the password, the 2-digit root number shown, and an optional transmitter number list, followed by (\*).

---



---

### Command Form:

Command	Form
Stop The Message On This Transmitter	(PW) 16 *
Stop The Message On These Transmitters	(PW) 16 x x x *

**Acknowledgment:** Sends *OK* message

### Errors:

Error	Meaning
? err 1	wrong number of digits entered
? err 2	Illegal digit entered

**Default:** None

### Examples:

If a message is playing on transmitter 3, you can enter a command on DTMF Decoder 3 to stop that message:

```
(PW) 16 *
```

If a message is playing on transmitters 1 and 2, you can enter a command on any DTMF Decoder or the serial port to stop the message on both transmitters:

```
(PW) 16 1 2 *
```

**Notes:**

---

## Chapter 7

# DTMF Decoder

---

Developed by AT&T in the early 1960s to replace pulse dialing in telephone networks, the Touch-Tone system is an example of a dual tone, multi-frequency signalling format. Now called DTMF by nearly everyone, it's used by amateur and commercial two-way radio users to transmit information within narrow voiceband channels.

DTMF turned out to be much more reliable than pulse dialing in telephone systems. It works well in narrowband radio systems, but it's not foolproof. It's an analog scheme that works best when understood and applied correctly.

There are 16 DTMF characters consisting of two summed tones, one from a low group (697, 770, 852, and 941 Hz) and one from a high group (1209, 1336, 1477, and 1633 Hz).

DTMF characters may be accompanied by speech, noise, and other audio, so encoders and decoders are designed to meet certain industry specifications to minimize errors.

The encoder must generate tones that are within  $\pm 1.5\%$  of their specified frequencies and have sufficient (and relatively similar) energy levels. Characters must persist for at least 40 milliseconds, and there must be an interval of at least 40 milliseconds between them. Noisy signals usually require longer duration characters and a somewhat wider gap between them.

The decoder must report valid characters while ignoring false ones.

The radio equipment that connects the encoder and decoder must provide a reasonably linear and low-noise path. Properly designed user radios mute the radio microphone while sending tones. Some inexpensive designs do not mute the microphone adding background sounds that can cause decoding issues.

In the 7330, you can enter DTMF command sequences to execute macros or to change the controller's programming. See the Programming section starting on page 3-3.

### *What can go wrong?*

A character might be below the sensitivity threshold of the decoder. It might be too short in duration or too far off-frequency. It might have too much *twist* (difference in amplitudes of the two tones). Noise, interference, and even mobile flutter can cause a valid character to be rejected, or make a long character appear as several. Speech or noise can be mistaken for valid characters, a problem known as *talk-off* or *falsing*.

### *How can reliability be improved?*

In user radios, set the DTMF encoder level below the clipping threshold to keep the tones in the transmitter's linear region. For links and repeaters, program the controller's tone output level so it's below the transmitter's clipping threshold. Clipping creates unnecessary distortion and *twist*. (*Twist* results when the transmitter's pre-emphasis/limiter stage clips the higher-frequency tone more severely than the lower-frequency tone.) Clipping can even generate audio intermodulation products resulting in unreliable decoding.

In the controller, set the receive audio levels as recommended in this manual. An overdriven decoder will false more often than a properly driven one.

Falsing can also be reduced by increasing the decoder's detection time. The telephone industry's standard timing requirements (40 ms of tone followed by 40 ms of silence) are a bit fast by radio standards. (Later in this chapter we'll describe a command that lengthens character detection time to reduce falsing.)

If your system has a problem with mobile flutter causing missed or duplicate digits, you might consider choosing macro names that never repeat a digit. For example, a user with mobile flutter might enter 71 but have it interpreted by the controller as 771 or 711 or 7711.

Even under ideal conditions, DTMF signalling is limited to 10 or 12 characters per second. Use the 7330's serial port to save time and reduce errors if you have a lot of programming to do (see Chapter 8). Loading upgrades and similar very large files is always done with the serial port; it's asking a lot to transfer thousands of characters without error with DTMF.

On the other hand, it's hard to beat the convenience of DTMF when you want to send a quick command from a mobile or handheld radio to the controller. The 7330's three industry-standard 8870-type DTMF decoders and three memory buffers allow it to accept commands from all three receivers simultaneously.

In this chapter we show you how to customize the various DTMF decoder features and the response messages.

## Effects of COR and CTCSS Filtering on DTMF Decoders

The time delays created by a receiver's COR filter, CTCSS filter, and antikerchunker affect not only transmitter keying but also DTMF decoding. For example, if a DTMF decoder is in carrier access mode and the COR input has a filter delay, then audio is not sent to the decoder until the filter delay ends.

While it might seem strange to have an antikerchunker on a DTMF decoder, it can be used to discourage troublemakers. The antikerchunker forces users to transmit for a while before entering a DTMF command, giving a direction finding team a bit more tracking time.

Other than the DTMF Decoder Disconnect Timer (see page 7-16), there is no timeout timer on Receiver-to-DTMF Decoder paths.

## DTMF Decoder Access Mode

This command programs the Access Mode for each of the receiver-to-DTMF decoder paths. It does not affect the access modes for the receiver-to-transmitter paths.

Each port has its own DTMF decoder, and each port is programmed separately. Access to a DTMF decoder can be OFF, ON, or dependent on its receiver COR and CTCSS inputs.

Here are some practical uses for the six access modes:

In **Access Mode 0 (No Access)**, no DTMF commands are accepted on that port. The COR and CTCSS inputs are ignored by the DTMF decoder, but may be used by the paths to the transmitters. This mode would be useful for a remote base port where you might not want to accept commands.

Obviously, if you disable all of the DTMF decoders by setting their access modes to 0, the only way to command the controller is via the serial port.

In **Access Mode 1 (Carrier)**, the COR input must be active to access the DTMF decoder. The CTCSS input is ignored by the DTMF decoder, but may be used by the paths to transmitters.

A CTCSS repeater normally cannot be accessed by carrier-only users, but setting its DTMF access mode to carrier allows any user to enter commands. If you create a macro that puts the receiver/transmitter path into carrier access, then any user can change the access to carrier temporarily and make a call. (Program the end-of-activity macro to return the repeater to CTCSS after the conversation ends.)

In **Access Mode 2 (CTCSS)**, the CTCSS input must be active to access the DTMF decoder. The COR input is ignored by the DTMF decoder, but may be used by the paths to transmitters.

In **Access Mode 3 (Carrier AND CTCSS)**, both the COR and CTCSS inputs must be active to access the DTMF decoder.

Both modes 2 and 3 limit DTMF commands to CTCSS users. Mode 3 is usually the better choice because it requires not only CTCSS but also a carrier (a CTCSS decoder can be falsed by adjacent-channel interference). This mode is also the most commonly used as some repeater receiver tone decoders respond more slowly than their COR circuits. By using the COR input ANDed with the CTCSS input the delay before the CTCSS decoder deciding that the tone has gone away is eliminated.

In **Access Mode 4 (Carrier OR CTCSS)**, either the COR input or the CTCSS input must be active to access the DTMF decoder.

In mode 4, carrier users and CTCSS users both have access. Since CTCSS decoders are more sensitive than squelch circuits, CTCSS users may find increased range (although DTMF decoding is difficult when the audio is noisy). Carrier users do not see any difference between mode 1 (Carrier) and 4 (Carrier OR CTCSS). If you tighten the receiver squelch to suppress band opening problems, CTCSS users may find they have better access than carrier users.

In **Access Mode 5 (Anti-CTCSS)**, the COR input must be active and the CTCSS input must be inactive to access the DTMF decoder.

This mode is helpful if your repeater is on the same channel as a CTCSS-accessed repeater. You can install a CTCSS decoder programmed to the other repeater's tone frequency. In mode 5, your DTMF decoder ignores the other system's users.

In **Access Mode 6 (Always ON)**, the DTMF decoder is always accessed. The COR and CTCSS inputs are ignored by the DTMF decoder, but may be used by the paths to the transmitters. This mode is useful for a receiver that lacks a COR output, such as a scanner. You can use one of these inexpensive receivers as a control receiver. This mode can also be used with wired links, for example where an IRLP or EchoLink node is linked by cable and you want this other device to use valid DTMF sequences to control your repeater without needing to assert COR or CTCSS.

Any of these scenarios is possible with the 7330!



---



---

## Select DTMF Decoder Access Mode

Selects the access mode for each DTMF decoder.

- Enter the password, the two-digit root number, the one-digit receiver number, and a one-digit mode number.

---



---

### Command Form:

Command	Form	Data Digit
Select Access Mode for RX 1 to DTMF Decoder 1	(PW) 57 1 x *	(see table below)
Select Access Mode for RX 2 to DTMF Decoder 2	(PW) 57 2 x *	
Select Access Mode for RX 3 to DTMF Decoder 3	(PW) 57 3 x *	

Mode	DTMF Access Mode	Explanation
0	No Access	The DTMF decoder is not accessible.
1	Carrier	The DTMF decoder is accessible when the COR input is active.
2	CTCSS	The DTMF decoder is accessible when the CTCSS input is active.
3	Carrier AND CTCSS	The DTMF decoder is accessible when both the COR input and the CTCSS input are active.
4	Carrier OR CTCSS	The DTMF decoder is accessible when either the COR input or the CTCSS input is active.
5	Anti-CTCSS	The DTMF decoder is accessible when the COR input is active and the CTCSS input is inactive.
6	Always On	The DTMF decoder is always accessible.

**Acknowledgment:** Sends OK message.

### Errors:

Error	Meaning
? err 1	wrong number of digits entered
? err 2	illegal digit entered

**Default Condition:** All DTMF decoders are in access mode 1 (Carrier).

### Examples:

To set receiver 1's DTMF Decoder Access Mode to 2 (CTCSS), enter:

(PW) 57 1 2 \*

To set receiver 2's DTMF Decoder Access Mode to 0 (No Access), enter:

(PW) 57 2 0 \*

To set receiver 3's DTMF Decoder Access Mode to 3 (Carrier AND CTCSS), enter:

(PW) 57 3 3 \*

## DTMF Decoder Anti-Falsing Timer

If a decoder is not being overdriven but still falses often, it may be detecting DTMF characters in the speech of certain users.

Falsing decreases when decode time increases because fewer invalid signals last long enough to register.

The normal decode time of 40 ms is set by a resistor and capacitor in the DTMF decoder circuit. You add more time to the 40 ms requirement (in ten-millisecond increments) with the anti-falsing timer.

Setting the anti-falsing timer to zero results in fastest decode. Most systems will work fine that way.

Increasing the detection time by just one or two increments fixes most falsing problems.

Too much detection time can cause characters to be missed. Programmed DTMF sequences from user radios can be as fast as 50 ms per character, and detection times much above 100 ms might result in human-entered characters being missed.

---



---

## Select DTMF Decoder Anti-Falsing Timer

Increases decode time beyond minimum set by hardware.

- Enter the password, the two-digit root number, the four-digit timer number, and a one- to five-digit time value in 0.01-second (10 millisecond) increments.

---



---

### Command Form:

Command	Form	Data Digits
Select RX 1 DTMF Decoder Anti-Falsing Time	(PW) 09 0108 xxx *	0-500 (0-5.00 seconds)
Select RX 2 DTMF Decoder Anti-Falsing Time	(PW) 09 0208 xxx *	
Select RX 3 DTMF Decoder Anti-Falsing Time	(PW) 09 0308 xxx *	

**Acknowledgment:** Sends *OK* message

### Errors:

Error	Meaning
? err 1	wrong number of digits entered
? err 2	illegal digit entered

**Default Condition:** The anti-falsing time is 0.00 seconds for all decoders.

### Example:

To add 60 milliseconds to the RX 2 DTMF decode time, enter:

```
(PW) 09 0208 6 *
```

The new minimum decode time for DTMF characters on RX 2 equals the 40 ms hardware decode time plus the 60 ms added by the anti-falsing timer, or 100 milliseconds total.

## DTMF Decoder Interdigit Timer

Traditionally, an interdigit timer cancels an unfinished command (see *Command Execution on DTMF Interdigit Timer* for another use for the interdigit timer).

An unfinished command might be from a user accidentally pressing keys or from DTMF decoder falsing. It might be from a user driving out of range or experiencing battery failure while entering commands. In any case, an unfinished command should be erased to keep it from becoming part of the next command.

The interdigit timer restarts at each DTMF character. If a command is only partially received and no more characters arrive, the timer eventually expires and the command is canceled.

The interdigit timer is programmed with the *Select DTMF Decoder Interdigit Timer* command.

Unkeying has the same effect as having the interdigit timer expire, also clearing an unfinished command.

---



---

## Select DTMF Decoder Interdigit Time

Selects the maximum DTMF interdigit time.

- Enter the password, the two-digit root number, the four-digit timer number, and a one- to three-digit time value in 0.01-second (10 millisecond) increments.

---



---

### Command Form:

Command	Form	Data Digits
Select RX 1 DTMF Decoder Interdigit Time	(PW) 09 0104 xxx *	20-990 (0.20-9.90 seconds)
Select RX 2 DTMF Decoder Interdigit Time	(PW) 09 0204 xxx *	
Select RX 3 DTMF Decoder Interdigit Time	(PW) 09 0304 xxx *	

**Acknowledgment:** Sends OK message

### Errors:

Error	Meaning
? err 1	wrong number of digits entered
? err 2	illegal digit entered

**Default Condition:** The interdigit time is 5.00 seconds.

### Example:

To set the RX 3 interdigit time to 3.50 seconds, enter:

```
(PW) 09 0304 350 *
```

## Command Execution on DTMF Interdigit Timer

The 7330 has interdigit timers, but on expiration they can either cancel a command or execute it. The choice is made with the *Enable/Disable Command Execution on DTMF Interdigit Timer* command.

Most owners will want the interdigit timer to cancel unfinished commands.

But with the *Command Execution on DTMF Interdigit Timer* feature, users can send commands without an Enter (\*) character. When the interdigit timer expires, the 7330 assumes the command is finished and executes it. It's useful when dealing with commercial radios that don't have star (\*) and pound (#) characters on their DTMF keyboards.

While it's true that commands can also be executed without the Enter character by dropping the carrier (see *Command Execution on End-of-Transmission*), that particular scheme doesn't work when there's a stuck mic+ holding up the repeater input.

The amount of time before the command is executed is set by the *Select DTMF Decoder Interdigit Timer* command.

---



---

## Enable/Disable Command Execution on DTMF Interdigit Timer

Selects whether expiration of the Interdigit Timer CANCELS or EXECUTES a command.

- Enter the password, the two-digit root number, the four-digit software switch number, and a single data digit (0 for CANCEL or 1 for EXECUTE).

---



---

### Command Form:

Command	Form	Data Digit
Enable/Disable Command Execution on DTMF Interdigit Timer for RX 1	(PW) 63 0104 x *	0 = disable = <u>cancel</u> the command when timer expires 1 = enable = <u>execute</u> the command when timer expires
Enable/Disable Command Execution on DTMF Interdigit Timer for RX 2	(PW) 63 0204 x *	
Enable/Disable Command Execution on DTMF Interdigit Timer for RX 3	(PW) 63 0304 x *	

**Acknowledgment:** Sends OK message

### Errors:

Error	Meaning
? err 1	wrong number of digits entered
? err 2	illegal digit entered

**Default Condition:** Feature is OFF (disabled) for all receivers. Partial commands are cancelled when the interdigit timer expires.

### Example:

If you want DTMF commands on RX 3 to be executed when the interdigit timer expires, enter:

(PW) 63 0304 1 \*

## End-of-Transmission Command Execution

This feature allows a user to execute a command by releasing the push-to-talk button instead of sending the Enter (\*) character. A 0.25-second delay prevents a partial command from being accidentally executed if the user's signal momentarily drops.

Note that the Enter character always executes commands whether or not the End-of-Transmission Command Execution feature is enabled. In fact, a user must send the Enter character if a signal from some other source keeps the receiver active since the controller sees no carrier drop.



---



---

## Enable/Disable End-of-Transmission Command Execution

Allows commands to be executed by ending the transmission (releasing PTT) instead of sending the Enter (\*) character.

- Enter the password, the two-digit root number, the four-digit software switch number, and a single data digit (0 for disabled or 1 for enabled).

---



---

### Command Form:

Command	Form	Data Digit
Enable/Disable End-of-Transmission Command Execution for RX 1	(PW) 63 0103 x *	0 = disabled 1 = enabled
Enable/Disable End-of-Transmission Command Execution for RX 2	(PW) 63 0203 x *	
Enable/Disable End-of-Transmission Command Execution for RX 3	(PW) 63 0303 x *	

**Acknowledgment:** Sends OK message

### Errors:

Error	Meaning
? err 1	wrong number of digits entered
? err 2	illegal digit entered

**Default condition:** The feature is OFF (disabled) for all receivers, which means the Enter (\*) character is required for all commands.

### Example:

To enable End-of-Transmission Command Execution for RX 1, enter:

```
(PW) 63 0103 1 *
```

A user on RX 1 now can release his PTT button to execute a command instead of sending the Enter (\*) character.

## 4th Digit Command Execution

You may want a very simple (or highly restricted) command system on one or more ports that accepts only macro commands and doesn't require the Enter (\*) character.

Since macro names are four digits, this system can be created by configuring the controller to execute commands on the fourth character.

---

**Warning:** If you enable this option, you will only be able to execute macros through that receiver's DTMF decoder. You won't be able to reverse the command through that receiver unless a macro exists that switches the feature off.

---

---



---

## Enable/Disable 4th Digit Command Execution

Turns ON or OFF the option to execute a command on the 4<sup>th</sup> digit.

- When enabled, an Enter character (\*) is not required for commands.
- Enter the password, the two-digit root number, the four-digit software switch number, and a single data digit (0 for disabled or 1 for enabled).

---



---

### Command Form:

Command	Form	Data Digit
Enable/Disable RX 1 Execute Command on 4 <sup>th</sup> Digit	(PW) 63 0107 x *	0 = disabled 1 = enabled
Enable/Disable RX 2 Execute Command on 4 <sup>th</sup> Digit	(PW) 63 0207 x *	
Enable/Disable RX 3 Execute Command on 4 <sup>th</sup> Digit	(PW) 63 0307 x *	

**Acknowledgment:** Sends OK message

### Errors:

Error	Meaning
? err 1	wrong number of digits entered
? err 2	illegal digit entered

**Default Condition:** This feature is OFF (disabled) for all receivers.

### Example:

To set up the RX 2 DTMF decoder to execute commands on the 4th digit, enter:

```
(PW) 63 0207 1 *
```

A user on RX 2 can now simply enter %**2**34+to execute macro 1234.

## DTMF Decoder Disconnect Timer

Sometimes it's useful to have a DTMF decoder listen for commands only at the beginning of a transmission. One benefit is a reduction in decoder falsing because the decoder is active only for a limited time.

The disconnect timer starts when the transmission begins. If no DTMF characters are detected by the time the timer expires, the controller will ignore the decoder for the remainder of the transmission. If a user hasn't entered the first DTMF character by then, he will have to unkey and make a new transmission.

The disconnect timer restarts each time a DTMF character is detected.

If this feature is disabled, the DTMF decoder will be active for the duration of the transmission.

There are two commands associated with this feature; one enables or disables it, and the other sets the duration of the timer.

---



---

## Enable/Disable DTMF Decoder Disconnect Timer

Allows controller to disconnect the DTMF decoder from a receiver if it appears no DTMF command will be entered during a transmission.

- Enter the password, the two-digit root number, the four-digit software switch number, and a single data digit (0 for disabled or 1 for enabled).

---



---

### Command Form:

Command	Form	Data Digit
Enable/Disable DTMF Decoder Disconnect Timer for RX 1	(PW) 63 0105 x *	0 = disabled 1 = enabled
Enable/Disable DTMF Decoder Disconnect Timer for RX 2	(PW) 63 0205 x *	
Enable/Disable DTMF Decoder Disconnect Timer for RX 3	(PW) 63 0305 x *	

**Acknowledgment:** Sends OK message

### Errors:

Error	Meaning
? err 1	wrong number of digits entered
? err 2	illegal digit entered

**Default Condition:** The feature is OFF (disabled) for all receivers.

### Example:

To enable the Disconnect Timer on the RX 3 DTMF decoder, enter:

```
(PW) 63 0305 1 *
```

Then select the time value with the Select DTMF Decoder Disconnect Timer command.

---



---

## Select DTMF Decoder Disconnect Timer

Programs the maximum amount of time the controller will listen for a DTMF character before disconnecting the DTMF decoder from a receiver.

- Enter the password, the two-digit root number, the four-digit timer number, and a one- to five-digit time value in 0.01-second (10 millisecond) increments.

---



---

### Command Form:

Command	Form	Data Digits
Enable/Disable DTMF Decoder Disconnect Timer for RX 1	(PW) 09 0107 xxxxx *	0-65535 (0-655.35 seconds)
Enable/Disable DTMF Decoder Disconnect Timer for RX 2	(PW) 09 0207 xxxxx *	
Enable/Disable DTMF Decoder Disconnect Timer for RX 3	(PW) 09 0307 xxxxx *	

**Acknowledgment:** Sends OK message

### Errors:

Error	Meaning
? err 1	wrong number of digits entered
? err 2	illegal digit entered

**Default Condition:** The DTMF Decoder Disconnect Timer defaults to 5.00 seconds for all receivers.

### Example:

To disconnect the RX 3 DTMF Decoder after 10.00 seconds if no command begins, enter:

```
(PW) 09 0307 1000 *
```

## DTMF Mute

The controller can block receiver/transmitter audio during the time a DTMF character appears. This feature is called DTMF mute, and it saves repeater users from having to hear the annoying tones. Since the characters don't appear on the repeater output, it also reduces the chance that hackers with decoders will learn your command codes.

If muting is disabled, DTMF characters are passed along from a receiver to a transmitter without interruption. This is useful, for example, when you want to control a DTMF-operated device that is monitoring a transmitter's output.

If muting is enabled, DTMF characters are removed from the audio.

Please note that the controller cannot instantly turn off the audio at the instant a character arrives. The DTMF decoder must be sure the character is a valid one, and there are some software processing steps that follow. So, the leading 40+ milliseconds of the DTMF character will pass to the transmitter before muting begins, resulting in a 40+ millisecond or short tone burst on the output. (The 7330's built-in hardware audio delay feature eliminates this burst. It is enabled by moving a jumper on the main board. See Installation, Appendix B.)

Some owners don't use the audio delay feature and rely on the mute feature to remove DTMF. In that case, the mute feature is more effective if the mute is extended beyond the end of a DTMF character so that the following character is fully muted. This extension is called mute hang time and is discussed next.

There are nine mute enable/disable switch-type commands, one for each receiver/transmitter path.

Note that DTMF decoding is not affected by having the mute either on or off.

---



---

## Enable/Disable DTMF Decoder Mute

Turns ON or OFF DTMF muting between any receiver and transmitter.

- Enter the password, the two-digit root number, the four-digit software switch number, and a single data digit (0 for disabled or 1 for enabled).

---



---

### Command Form:

Command	Form	Data Digit
Enable/Disable RX 1-TX 1 DTMF Mute	(PW) 63 0151 x *	0 = disabled 1 = enabled
Enable/Disable RX 2-TX 1 DTMF Mute	(PW) 63 0152 x *	
Enable/Disable RX 3-TX 1 DTMF Mute	(PW) 63 0153 x *	
Enable/Disable RX 1-TX 2 DTMF Mute	(PW) 63 0251 x *	
Enable/Disable RX 2-TX 2 DTMF Mute	(PW) 63 0252 x *	
Enable/Disable RX 3-TX 2 DTMF Mute	(PW) 63 0253 x *	
Enable/Disable RX 1-TX 3 DTMF Mute	(PW) 63 0351 x *	
Enable/Disable RX 2-TX 3 DTMF Mute	(PW) 63 0352 x *	
Enable/Disable RX 3-TX 3 DTMF Mute	(PW) 63 0353 x *	

**Acknowledgment:** Sends OK message

### Errors:

Error	Meaning
? err 1	wrong number of digits entered
? err 2	illegal digit entered

**Default Condition:** All DTMF mutes are enabled.

### Example:

To turn off the DTMF mute between receiver 1 and transmitter 1, enter:

(PW) 63 0151 0 \*



## DTMF Mute Hang Time

The controller can be programmed to continue muting for a while after a DTMF character ends. When this feature is on and characters are sent in reasonably quick succession, each character after the first is fully muted (no initial burst).

This delay in turning the audio back on is called mute hang time. When the mute hang time is zero, the mute stops when the character ends.

The 7330 has two separate mute hang times, one for the first character and one for the characters that follow.

Why?

Because the first character might be falsed from speech, and if so, we don't want a long mute to chop out words. But if it's the first character in a string, we want the normal mute hang time for the characters that follow.

So, we have two commands: *Select DTMF Decoder Mute Hang Time for First Character, Star, Pound and Long Tone*, and *Select DTMF Decoder Mute Hang Time for Other Characters*. You can separately choose the %first character+hang time and the %other characters+hang time with these commands. (We include the star (\*) and pound (#) characters with the first character when it comes to hang time because they usually appear at the end of a string where a long hang time is not needed.)

---



---

## Select DTMF Decoder Mute Hang Time for First Character, Star, Pound and Long Tone

Sets the amount of mute hang time for the first DTMF character in a string, the star (\*), the pound (#) and a Long Tone.

- Enter the password, the two-digit root number, the four-digit timer number, and a one- to three-digit time value in 0.01-second (10 millisecond) increments.
- 
- 

### Command Form:

Command	Form	Data Digit
Select DTMF Decoder Mute Hang Time for First Character for RX1	(PW) 09 0105 xxx *	0. 200 (0.00. 2.00 seconds)
Select DTMF Decoder Mute Hang Time for First Character for RX2	(PW) 09 0205 xxx *	
Select DTMF Decoder Mute Hang Time for First Character for RX3	(PW) 09 0305 xxx *	

**Acknowledgment:** Sends OK message

### Errors:

Error	Meaning
? err 1	wrong number of digits entered
? err 2	illegal digit entered

**Default Condition:** The First Character Mute Hang Time is 0.50 seconds.

### Example:

To set the first character+hang time on receiver 2's DTMF decoder to 0.35 seconds, enter:

```
(PW) 09 0205 35 *
```

---



---

## Select DTMF Decoder Mute Hang Time for Other Characters

Sets the amount of mute hang time for the characters following the first.

- Enter the password, the two-digit root number, the four-digit timer number, and a one- to three-digit time value in 0.01-second (10 millisecond) increments.

---



---

### Command Form:

Command	Form	Data Digit
Select DTMF Decoder Mute Hang Time for Other Characters for RX 1	(PW) 09 0106 xxx *	0. 200 (0.00. 2.00 seconds)
Select DTMF Decoder Mute Hang Time for Other Characters for RX 2	(PW) 09 0206 xxx *	
Select DTMF Decoder Mute Hang Time for Other Characters for RX 3	(PW) 09 0306 xxx *	

**Acknowledgment:** Sends OK message

### Errors:

Error	Meaning
? err 1	wrong number of digits entered
? err 2	illegal digit entered

**Default Condition:** The Other Character Mute Hang Time is 0.50 seconds.

### Example:

To set the other character mute hang time on receiver 2 of DTMF decoder to 0.65 seconds, enter:

```
(PW) 09 0206 65 *
```

## DTMF Mute Bypass

When DTMF Mute is enabled on a receiver-to-transmitter path, all DTMF digits are muted. But there may be times when you temporarily want DTMF digits to be passed by the controller across one or more paths.

Here's an example. Let's say you have an off-site IRLP node with a receiver that is listening to the output of your repeater. You would like to normally have the RX1-TX1 repeater audio path DTMF Mute enabled so that DTMF digits are not heard by all users of the repeater. But when you want to control the IRLP node, you want to be able to temporarily disable the DTMF Mute for that one transmission. That's what this feature is for.

When you enable the *DTMF Mute Bypass* feature on a path, the DTMF decoder checks for the pound (#) character as the first digit entered after you key up. If it doesn't find the pound (#) character, the mute and cover tone operate normally. A properly entered command is executed.

When the pound (#) character is detected as the first digit entered, mute is turned off on the paths from that receiver that have the feature enabled. Also, all other DTMF digits are ignored by the controller during this transmission. Having the controller ignore the digits prevents your 7330 from executing commands that weren't meant for it.

Entering a pound (#) character while entering a command erases all digits that the controller has decoded and stored up to that point (see page 3-7).

---



---

## Enable/Disable DTMF Mute Bypass

Turns ON or OFF DTMF Mute Bypass between any receiver and transmitter.

- Enter the password, the two-digit root number, the four-digit software switch number, and a single data digit (0 for disabled or 1 for enabled).

---



---

### Command Form:

Command	Form	Data Digit
Enable/Disable RX 1-TX 1 DTMF Mute Bypass	(PW) 63 0181 x *	0 = disabled 1 = enabled
Enable/Disable RX 2-TX 1 DTMF Mute Bypass	(PW) 63 0182 x *	
Enable/Disable RX 3-TX 1 DTMF Mute Bypass	(PW) 63 0183 x *	
Enable/Disable RX 1-TX 2 DTMF Mute Bypass	(PW) 63 0281 x *	
Enable/Disable RX 2-TX 2 DTMF Mute Bypass	(PW) 63 0282 x *	
Enable/Disable RX 3-TX 2 DTMF Mute Bypass	(PW) 63 0283 x *	
Enable/Disable RX 1-TX 3 DTMF Mute Bypass	(PW) 63 0381 x *	
Enable/Disable RX 2-TX 3 DTMF Mute Bypass	(PW) 63 0382 x *	
Enable/Disable RX 3-TX 3 DTMF Mute Bypass	(PW) 63 0383 x *	

**Acknowledgment:** Sends OK message

### Errors:

Error	Meaning
? err 1	wrong number of digits entered
? err 2	illegal digit entered

**Default Condition:** All DTMF Mute Bypass are disabled.

### Example:

To turn on the DTMF Mute Bypass between receiver 1 and transmitter 1, enter:

(PW) 63 0181 1 \*

## DTMF Cover Tone

When a user or a control operator is entering a DTMF command into the controller and the DTMF Mute is enabled, there is no audio being repeated. This can be confusing to listeners. Some listeners might think there's a jammer on the frequency. Other listeners might think the repeater is not in use and key up interrupting the commanding in progress.

To make it clear that the repeater is in use, the controller can be programmed to generate a repeating *DTMF Cover Tone Message*. A unique repeating message and a repeat interval can be configured for each transmitter.

The DTMF Cover Tone Message can be programmed to be any valid controller message. The default message is a brief double beep. You can replace this message with a message defining other beeps, tone sequences, or speech words.

By default, the DTMF Cover Tone is disabled. To enable it, you change the DTMF Cover Tone Interval from zero to any value up to 2.00 seconds in 10 millisecond increments. An interval of 0.75 ms creates an effective cover tone. This interval is unrelated to the number of DTMF digits being decoded or the rate they are being decoded. This improves security against hackers.

---



---

## Select DTMF Cover Tone Interval

Sets the maximum interval at which DTMF Cover Tone Messages occur.

- Enter the password, the two-digit root number, the four-digit timer number, and a one- to three-digit time value in 0.01-second (10 millisecond) increments.
- Set the DTMF Cover Tone Interval to zero to disable DTMF Cover Tones for this transmitter.

---



---

### Command Form:

Command	Form	Data Digit
Select DTMF Cover Tone Interval for TX1	(PW) 09 0119 xxx *	0. 200 (0.00. 2.00 seconds)
Select DTMF Cover Tone Interval for TX2	(PW) 09 0219 xxx *	
Select DTMF Cover Tone Interval for TX3	(PW) 09 0319 xxx *	

**Acknowledgment:** Sends OK message

### Errors:

Error	Meaning
? err 1	wrong number of digits entered
? err 2	illegal digit entered

**Default Condition:** The DTMF Cover Tone Interval is 0.00 seconds, disabled.

### Example:

To set the DTMF Cover Tone Interval on TX1 to 0.75 seconds, enter:

(PW) 09 0119 75 \*

---



---

## Select/Review DTMF Cover Tone Message

Change or review a DTMF cover tone message.

- Enter the password, the two-digit root number and four-digit message number, followed by the desired message.
- The message may contain any combination of message types, including CW, beeps, page tones, speech, etc.
- The maximum size of any message is 50 bytes (50 two-digit codes).
- You must count the control character. Therefore, any message could have 46 CW characters, 23 speech words, and so on.
- To delete a message, enter the password, the two-digit root number, the four-digit message number, and the (\*) (do not enter any message).
- To review a message, enter the password, the two-digit root number, and the four-digit message number shown.

---



---

### Command Form:

Command	Form	Default
Select DTMF Cover Tone Message for TX1	(PW) 31 0113 (message) *	(See below)
Select DTMF Cover Tone Message for TX2	(PW) 31 0213 (message) *	(See below)
Select DTMF Cover Tone Message for TX3	(PW) 31 0313 (message) *	(See below)
Review DTMF Cover Tone Message for TX1	(PW) 34 0113 *	
Review DTMF Cover Tone Message for TX2	(PW) 34 0213 *	
Review DTMF Cover Tone Message for TX3	(PW) 34 0313 *	

**Acknowledgment:** Sends OK message

### Errors:

Error	Meaning
? err 1	wrong number of digits entered
? err 2	illegal digit entered

**Default Condition:** Two 587Hz beeps each 20 ms long spaced 60 ms apart,  
9910 56 71 64 14 14

### Examples:

To change the TX2 cover tone message to a CW % $\bar{E}$ +, enter:

```
(PW) 31 0213 9900 14 *
```



## Any-Character Macro

The *Any-Character Macro* is triggered as soon as any DTMF character is detected. `%Detected+` means the character is considered valid. The character `%end` does not affect this feature.

You can use the *Any-Character Macro* to implement `%cover tones+`, which indicate incoming DTMF. Without cover tones, listeners may not be aware of incoming DTMF characters when muting is enabled and may talk over them.

To build a cover tone system, create a macro that sends a short character and trigger it with the *Any-Character Macro* feature. You can experiment with beeps or short CW characters, avoiding very long characters or multiple characters. A long cover tone message might last extend well beyond the incoming DTMF command.

---



---

## Select DTMF Decoder Any-Character Macro

Assigns a macro to be triggered when any DTMF character is first decoded.

- Enter the password, the two-digit root number, the four-digit event-triggered macro number, and the four-digit macro name desired. Use leading zeros if the macro name has fewer than four digits.
  - To unassign a previously assigned macro, enter the password, the two-digit root number, the four-digit event-triggered macro number, and the (\*).
- 
- 

### Command Form:

Command	Form
Select DTMF Any-Character Macro for RX 1	(PW) 26 0101 (macro name) *
Select DTMF Any-Character Macro for RX 2	(PW) 26 0201 (macro name) *
Select DTMF Any-Character Macro for RX 3	(PW) 26 0301 (macro name) *

**Acknowledgment:** Sends *OK* message

### Errors:

Error	Meaning
? err 1	wrong number of digits entered
? err 2	illegal digit entered

**Default Condition:** None assigned.

### Example:

To trigger macro 6789 when any DTMF character is detected on receiver 2, enter:

```
(PW) 26 0201 6789 *
```

## Long Tones

A long tone is a continuous DTMF character of a duration equal to or greater than the long tone timer (three seconds is common).

When a user sends a long tone, two macros are executed: *The Any Long Tone Macro* and the long tone macro associated with that character.

This system is compatible with the ARRL's nationwide LiTZ+(Long-Tone Zero) program. It asks amateurs to monitor for a three-second DTMF 0 sent by a user in an emergency situation.

It goes beyond LiTZ in that each of the 16 DTMF characters can trigger a separate macro.

There are four commands associated with long tones:

*Enable/Disable DTMF Long Tones* turns the feature on and off for each receiver.

*Select DTMF Long Tone Time* chooses the duration required for a DTMF character to be a long tone.

*Select DTMF Long Tone Macros* chooses the macro to be triggered by each DTMF long tone character for each receiver.

*Select DTMF Any Long Tone Macro* chooses the macro to be triggered by any DTMF long tone character for each receiver.

The macro is executed on the trailing edge of the long tone.

A long tone is a standalone signal that triggers a macro. It is not considered part of a command string and therefore the character is not placed into the command buffer. There must not be any other characters in the command buffer when the long tone is received.

There are many applications for long tones because they are more easily remembered than a command string. For example, one long tone can switch the repeater from CTCSS access to carrier access while another sends a tone page that alerts an emergency team.

---



---

## Enable/Disable DTMF Long Tones

Turns ON or OFF the controller's ability to execute macros based on reception of long DTMF characters.

- Enter the password, the two-digit root number, the four-digit software switch number, and a single data digit (0 for disabled or 1 for enabled).

---



---

### Command Form:

Command	Form	Data Digit
Enable/Disable DTMF Long Tones for RX 1	(PW) 63 0106 x *	0 = disabled 1 = enabled
Enable/Disable DTMF Long Tones for RX 2	(PW) 63 0206 x *	
Enable/Disable DTMF Long Tones for RX 3	(PW) 63 0306 x *	

**Acknowledgment:** Sends *OK* message

### Errors:

Error	Meaning
? err 1	wrong number of digits entered
? err 2	illegal digit entered

**Default Condition:** The DTMF Long Tone feature is disabled on all receivers.

### Example:

To enable the long tone feature on receiver 1, enter:

```
(PW) 63 0106 1 *
```

---



---

## Select DTMF Long Tone Timer

Sets the time required to recognize a long tone DTMF character.

- Enter the password, the two-digit root number, the four-digit timer number, and a one- to five-digit time value in 0.1-second (100 millisecond) increments.

---



---

### Command Form:

Command	Form	Data Digits
Select DTMF Long Tone Timer for RX1	(PW) 09 1103 xxxxx *	0. 65535 (0.0. 6553.5 seconds)
Select DTMF Long Tone Timer for RX2	(PW) 09 1203 xxxxx *	
Select DTMF Long Tone Timer for RX3	(PW) 09 1303 xxxxx *	

**Acknowledgment:** Sends *OK* message

### Errors:

Error	Meaning
? err 1	wrong number of digits entered
? err 2	illegal digit entered

**Default Condition:** All long tone timers are 3.0 seconds.

### Example:

To change the duration of a long tone to 5.0 seconds on receiver 3, enter:

```
(PW) 09 1303 50 *
```

---



---

## Select DTMF Long Tone Macro

Assigns a macro to be executed by the Long Tone shown.

- Enter the password, the two-digit root number, the four-digit event-triggered macro number, and the macro name to be executed by the long tone.
- Use leading zeroes if the macro name has fewer than four digits.
- To unassign a previously assigned macro, enter the password, the root number, the event-triggered macro number, and the (\*).

---



---

### Command Form:

Command	Form
Assign Macro to Long Tone Zero for RX1	(PW) 26 0184 (macro name) *
Assign Macro to Long Tone One for RX1	(PW) 26 0185 (macro name) *
Assign Macro to Long Tone Two for RX1	(PW) 26 0186 (macro name) *
Assign Macro to Long Tone Three for RX1	(PW) 26 0187 (macro name) *
Assign Macro to Long Tone Four for RX1	(PW) 26 0188 (macro name) *
Assign Macro to Long Tone Five for RX1	(PW) 26 0189 (macro name) *
Assign Macro to Long Tone Six for RX1	(PW) 26 0190 (macro name) *
Assign Macro to Long Tone Seven for RX1	(PW) 26 0191 (macro name) *
Assign Macro to Long Tone Eight for RX1	(PW) 26 0192 (macro name) *
Assign Macro to Long Tone Nine for RX1	(PW) 26 0193 (macro name) *
Assign Macro to Long Tone A for RX1	(PW) 26 0194 (macro name) *
Assign Macro to Long Tone B for RX1	(PW) 26 0195 (macro name) *
Assign Macro to Long Tone C for RX1	(PW) 26 0196 (macro name) *
Assign Macro to Long Tone D for RX1	(PW) 26 0197 (macro name) *
Assign Macro to Long Tone Star (*) for RX1	(PW) 26 0198 (macro name) *
Assign Macro to Long Tone Pound (#) for RX1	(PW) 26 0199 (macro name) *

Command	Form
Assign Macro to Long Tone Zero for RX2	(PW) 26 0284 (macro name) *
Assign Macro to Long Tone One for RX2	(PW) 26 0285 (macro name) *
Assign Macro to Long Tone Two for RX2	(PW) 26 0286 (macro name) *
Assign Macro to Long Tone Three for RX2	(PW) 26 0287 (macro name) *
Assign Macro to Long Tone Four for RX2	(PW) 26 0288 (macro name) *
Assign Macro to Long Tone Five for RX2	(PW) 26 0289 (macro name) *
Assign Macro to Long Tone Six for RX2	(PW) 26 0290 (macro name) *
Assign Macro to Long Tone Seven for RX2	(PW) 26 0291 (macro name) *
Assign Macro to Long Tone Eight for RX2	(PW) 26 0292 (macro name) *
Assign Macro to Long Tone Nine for RX2	(PW) 26 0293 (macro name) *
Assign Macro to Long Tone A for RX2	(PW) 26 0294 (macro name) *
Assign Macro to Long Tone B for RX2	(PW) 26 0295 (macro name) *
Assign Macro to Long Tone C for RX2	(PW) 26 0296 (macro name) *
Assign Macro to Long Tone D for RX2	(PW) 26 0297 (macro name) *
Assign Macro to Long Tone Star (*) for RX2	(PW) 26 0298 (macro name) *
Assign Macro to Long Tone Pound (#) for RX2	(PW) 26 0299 (macro name) *
Assign Macro to Long Tone Zero for RX3	(PW) 26 0384 (macro name) *
Assign Macro to Long Tone One for RX3	(PW) 26 0385 (macro name) *
Assign Macro to Long Tone Two for RX3	(PW) 26 0386 (macro name) *
Assign Macro to Long Tone Three for RX3	(PW) 26 0387 (macro name) *
Assign Macro to Long Tone Four for RX3	(PW) 26 0388 (macro name) *
Assign Macro to Long Tone Five for RX3	(PW) 26 0389 (macro name) *
Assign Macro to Long Tone Six for RX3	(PW) 26 0390 (macro name) *
Assign Macro to Long Tone Seven for RX3	(PW) 26 0391 (macro name) *
Assign Macro to Long Tone Eight for RX3	(PW) 26 0392 (macro name) *
Assign Macro to Long Tone Nine for RX3	(PW) 26 0393 (macro name) *
Assign Macro to Long Tone A for RX3	(PW) 26 0394 (macro name) *
Assign Macro to Long Tone B for RX3	(PW) 26 0395 (macro name) *
Assign Macro to Long Tone C for RX3	(PW) 26 0396 (macro name) *
Assign Macro to Long Tone D for RX3	(PW) 26 0397 (macro name) *
Assign Macro to Long Tone Star (*) for RX3	(PW) 26 0398 (macro name) *
Assign Macro to Long Tone Pound (#) for RX3	(PW) 26 0399 (macro name) *

**Acknowledgment:** Sends OK message

**Errors:**

Error	Meaning
? err 1	wrong number of digits entered
? err 2	illegal digit entered

**Default Condition:** No macros assigned

**Example:**

To trigger macro 1234 when a long tone zero (0) is detected on receiver 1, enter:

```
(PW) 26 0184 1234 *
```

---



---

## Select DTMF Any Long Tone Macro

Assigns a macro to be executed by any long tone on each receiver.

- Enter the password, the two-digit root number, the four-digit event-triggered macro number, and the macro name to be executed when any long tone is decoded.
- Use leading zeroes if the macro name has fewer than four digits.
- To unassign a previously assigned macro, enter the password, the root number, the event-triggered macro number, and the (\*).

---



---

### Command Form:

Command	Form
Assign Macro to Any Long Tone for RX1	(PW) 26 0100 (macro name) *
Assign Macro to Any Long Tone for RX2	(PW) 26 0200 (macro name) *
Assign Macro to Any Long Tone for RX3	(PW) 26 0300 (macro name) *

**Acknowledgment:** Sends OK message

### Errors:

Error	Meaning
? err 1	wrong number of digits entered
? err 2	illegal digit entered

**Default Condition:** No macro assigned.

### Example:

To trigger macro 5678 when any long tone is detected on receiver 2, enter:

(PW) 26 0200 5678 \*



## Command Response Messages

The controller sends a Command Response Message when it accepts a valid command or rejects an invalid one. These responses may be turned on and off.

In most cases, the response to a valid command is %OK+in CW. You can change the response message to something else, if you wish.

In other cases, the response to a valid command is a specific message other than %OK+. Commands that review programmable messages, play messages contained within the command, and listing the contents of macros are in this category.

The response to most invalid commands is %ERR 1+in CW (wrong number of digits) or %ERR 2+in CW (illegal digit). You can change these response messages to something else, if you wish.

There are a few additional error messages, such as the %not found+message used in commands that manipulate macros. The commands described here affect the %OK+, %ERR 1+, %ERR 2+, and other error response messages.

The *Select/Review Programmable Command Response Messages* commands allow you to change the %OK+, %ERR 1+, and %ERR 2+responses to some other message that you prefer.

There are commands used to enable and disable command response messages.

- The *Enable/Disable Command Response Messages* command turns on or off all %OK+, %ERR 1+, %ERR 2+, and other error response messages for each receiver/DTMF decoder. As a rule, you will want these messages enabled when programming (unless you are sure that your script doesn't contain errors).
- The *Enable/Disable OK Command Response Messages* command turns on or off the %OK+response message for each receiver/DTMF decoder. It may be beneficial to turn off the %OK+response after you've created macros and tested them to be sure they work correctly. If the %OK+response is enabled, you'll hear %OK+from each command in a macro when the macro is executed.
- The *Enable/Disable Error Command Response Messages* command turns on or off the %ERR 1+, %ERR 2+, and other error response messages for each receiver/DTMF decoder.
- The *Enable/Disable Command Responses In Macros* command turns on or off all %OK+and error response messages from commands within a macro.

---



---

## Enable/Disable Command Response Messages

Turns ON or OFF all command responses (error and acknowledgment messages) returned to the programmer.

- This command affects command responses from commands entered by DTMF.
  - Enter the password, the two-digit root number, the four-digit software switch number, and a single data digit (0 for disabled or 1 for enabled).
- 
- 

### Command Form:

Command	Form	Data Digit
Enable/Disable Command Response Messages for RX 1	(PW) 63 0100 x *	0 = disabled 1 = enabled
Enable/Disable Command Response Messages for RX 2	(PW) 63 0200 x *	
Enable/Disable Command Response Messages for RX 3	(PW) 63 0300 x *	

**Acknowledgment:** Sends OK message

### Errors:

Error	Meaning
? err 1	wrong number of digits entered
? err 2	illegal digit entered

**Default Condition:** Command Response Messages are enabled.

### Examples:

To disable the %OK+, %ERR 1+, and %ERR 2+ response messages for receiver 1, enter:

```
(PW) 63 0100 0 *
```

To enable them, enter:

```
(PW) 63 0100 1 *
```

---



---

## Enable/Disable Command Responses In Macros

Turns ON or OFF command responses from commands executed within a macro.

- This command affects command responses from commands entered by DTMF.
- Enter the password, the two-digit root number, the four-digit software switch number, and a single data digit (0 for disabled or 1 for enabled).

---



---

### Command Form:

Command	Form	Data Digit
Enable/Disable Command Responses In Macros for RX1	(PW) 63 0118 x *	0 = disabled 1 = enabled
Enable/Disable Command Responses In Macros for RX2	(PW) 63 0218 x *	
Enable/Disable Command Responses In Macros for RX3	(PW) 63 0318 x *	

**Acknowledgment:** Sends *OK* message

### Errors:

Error	Meaning
? err 1	wrong number of digits entered
? err 2	illegal digit entered

**Default Condition:** Command Responses In Macros are OFF (disabled)

### Examples:

To disable command responses in macros for receiver 1, enter:

```
(PW) 63 0118 0 *
```

To enable them, enter:

```
(PW) 63 0118 1 *
```

---



---

## Enable/Disable OK Command Response Messages

Turns ON or OFF the OK command responses returned to the programmer.

- This command affects command responses from commands entered by DTMF.
- Enter the password, the two-digit root number, the four-digit software switch number, and a single data digit (0 for disabled or 1 for enabled).

---



---

### Command Form:

Command	Form	Data Digit
Enable/Disable OK Command Response Messages for RX1	(PW) 63 0101 x *	0 = disabled 1 = enabled
Enable/Disable OK Command Response Messages for RX2	(PW) 63 0201 x *	
Enable/Disable OK Command Response Messages for RX3	(PW) 63 0301 x *	

**Acknowledgment:** Sends OK message

### Errors:

Error	Meaning
? err 1	wrong number of digits entered
? err 2	illegal digit entered

**Default Condition:** OK Command Response Messages are ON (enabled)

### Examples:

To disable the %OK+response messages for receiver 1, enter:

```
(PW) 63 0101 0 *
```

To enable them, enter:

```
(PW) 63 0101 1 *
```

---



---

## Enable/Disable Error Command Response Messages

Turns ON or OFF the Error command responses returned to the programmer.

- This command affects command responses from commands entered by DTMF.
- Enter the password, the two-digit root number, the four-digit software switch number, and a single data digit (0 for disabled or 1 for enabled).

---



---

### Command Form:

Command	Form	Data Digit
Enable/Disable Error Command Response Messages for RX1	(PW) 63 0102 x *	0 = disabled 1 = enabled
Enable/Disable Error Command Response Messages for RX2	(PW) 63 0202 x *	
Enable/Disable Error Command Response Messages for RX3	(PW) 63 0302 x *	

**Acknowledgment:** Sends OK message

### Errors:

Error	Meaning
? err 1	wrong number of digits entered
? err 2	illegal digit entered

**Default Condition:** Error Command Response Messages are ON (enabled)

### Examples:

To disable the %ERR 1+and %ERR 2+response messages for receiver 1, enter:

```
(PW) 63 0102 0 *
```

To enable them, enter:

```
(PW) 63 0102 1 *
```

---



---

## Select/Review Programmable Command Response Messages

Changes or reviews the command response messages.

- Enter the password, the two-digit root number and four-digit message number, followed by the desired message.
- The message may contain any combination of message types, including CW, beeps, page tones, speech, etc.
- The maximum size of any message is 50 bytes (50 two-digit codes).
- You must count the control character. Therefore, any message could have 46 CW characters, 23 speech words, and so on.
- To delete a message, enter the password, the two-digit root number, the four-digit message number, and the (\*) (do not enter any message).
- To review a message, enter the password, the two-digit root number, and the four-digit message number shown.

---



---

### Command Form:

Command	Form	Default
Select OK Command Response Message	(PW) 31 0001 (message) *	OK in CW
Select Error 1 Command Response Message	(PW) 31 0002 (message) *	?ERR1 in CW
Select Error 2 Command Response Message	(PW) 31 0003 (message) *	?ERR2 in CW
Review OK Command Response Message	(PW) 34 0001 *	
Review Error 1 Command Response Message	(PW) 34 0002 *	
Review Error 1 Command Response Message	(PW) 34 0003 *	

**Acknowledgment:** Sends OK message

### Errors:

Error	Meaning
? err 1	wrong number of digits entered
? err 2	illegal digit entered

**Default Condition:** See the Default column in the Command Form table.

### Examples:

To change the %OK+response message to a CW %E+, enter:

```
(PW) 31 0001 9900 14 *
```

---

## Chapter 8

# Serial (RS-232) Commands

---

### Overview

The 7330 Controller has two serial port connectors on the rear panel of the controller labeled RS232-1 (the DE9P male connector) and RS232-2 (the DE9S female connector). Either port can be configured as the *Console* port, the port that you use to enter commands to the repeater controller. Whichever serial port is not being used as the Console port is used as the *Auxiliary* port.

The 7330 Repeater firmware accepts commands on the Console port. This Console port has a dedicated command queue so that commands can be processed without being delayed by user commands from the DTMF decoders. Controller commands using DTMF digits entered via the Console port have the same format as commands entered via DTMF on a radio port. In addition, there are ASCII commands that are only accepted on the Console port.

The Auxiliary port is reserved for future use.

This chapter describes the uses of the Console port, the command formats, how to send a text file of commands, how to manage files in your controller, how to configure the serial ports, viewing the remote front panel and how to use the PC-based report utility.

## Serial Port Configuration

By default, a new 7330 Controller is configured with the Console port assigned to DE9S connector RS232-2 and the Auxiliary port assigned to DE9P connector RS232-1. The port configurations default to the following parameters:

### Console Port Default

Parameter	Value
Baud Rate	57,600
Data Bits	8
Parity	None
Stop Bits	1
Flow Control	None

### Auxiliary (Aux) Port Default

Parameter	Value
Baud Rate	9600
Data Bits	8
Parity	None
Stop Bits	1
Flow Control	None

### Changing the Defaults

The 7330 Controller's SBOOT utility has options for changing the serial port baud rates and port assignments. (See *Controller Command Format*, later in this chapter, for instructions on how to run the SBOOT utility.)

On the SBOOT main menu, the following options are available:

```
P - Set Baud Rate of Console Port
N - Set Baud Rate of Auxiliary Port
W - Set Console Port Number
```



## Changing the Console Port Baud Rate

To set the baud rate of the Console port, type **P**. The following baud rates are available:

```
Select a Baud Rate for Console Port
Currently set to 57600
0 - 1200
1 - 2400
2 - 4800
3 - 9600
4 - 19200
5 - 38400
6 - 57600
Q - Return to Main Menu
H - Redisplay these options
```

Your command sequence will look like this:

```
SBOOT> p

Select a Baud Rate for Console Port
Currently set to 57600
0 - 1200
1 - 2400
2 - 4800
3 - 9600
4 - 19200
5 - 38400
6 - 57600
Q - Return to Main Menu
H - Redisplay these options

Enter Baud Rate Option> 6

Setting Console Port Baud Rate to 57600

SBOOT>
```

**Q** returns you to the Main Menu shown on page 8-14.

## Changing the Auxiliary Port Baud Rate

To set the baud rate of the Auxiliary port, type N. The following baud rates are available:

```
Select a Baud Rate for Auxiliary Port
Currently set to 9600
0 - 1200
1 - 2400
2 - 4800
3 - 9600
4 - 19200
5 - 38400
6 - 57600
Q - Return to Main Menu
H - Redisplay these options
```

Your command sequence will look like this:

```
SBOOT> p

Select a Baud Rate for Auxiliary Port
Currently set to 9600
0 - 1200
1 - 2400
2 - 4800
3 - 9600
4 - 19200
5 - 38400
6 - 57600
Q - Return to Main Menu
H - Redisplay these options

Enter Baud Rate Option> 3

Setting Auxiliary Port baud rate to 9600

SBOOT>
```

Q returns you to the Main Menu shown on page 8-14.

## Changing the Port Assignments

To change the serial port assignments, type `w`. The following port assignments are available:

```
Select Serial Port Assignments
Console Port is currently on RS232-2
Auxiliary Port is currently on RS232-1
 1 - Console Port on RS232-1, Auxiliary Port on RS232-2
 2 - Console Port on RS232-2, Auxiliary Port on RS232-1
 Q - Return to Main Menu
 H - Redisplay these options
```

Your command sequence will look like this:

```
SBOOT> w

Select Serial Port Assignments
Console Port is currently on RS232-1
Auxiliary Port is currently on RS232-2
 1 - Console Port on RS232-1, Auxiliary Port on RS232-2
 2 - Console Port on RS232-2, Auxiliary Port on RS232-1
 Q - Return to Main Menu
 H - Redisplay these options

Enter Option> 1

Setting Console Port to RS232-1, setting Auxiliary Port to
RS232-2

SBOOT>
```

`Q` displays the Main Menu shown on page 8-14.

## Cold Start Effects, None

The serial port configuration is *not* changed during a Cold Start. (See page 2-6.) This ensures that you are still able to enter Console commands after the Cold Start of the controller.

## Flow Control, None

There is no flow control or modem control available on either port.

## Cabling

The 7330 Controller serial port RS232-2 DE9S 9-pin female connector is wired as a DCE (Data Communication Equipment). Serial port RS232-1 9-pin male connector is wired as a DTE (Data Terminal Equipment). (See Appendix B, *Installation*, page B-18, for pinout details.)

When RS232-2 is configured as the Console, you can connect the 7330 serial port RS232-2 to a personal computer's COM port using a 9-pin serial straight-through cable. (A straight-through cable has a male connector on one end, a female connector on the other end and can be used as a serial port extension cord.) Only the TXD, RXD, and ground pins need to be connected:

7330 RS232-2 DE9S DCE	Personal Computer DE9P
Pin 2, TXD	Pin 2, RXD
Pin 3, RXD	Pin 3, TXD
Pin 5, Ground	Pin 5, Ground

When RS232-1 is configured as the Console, you can connect the 7330 serial port RS232-1 to a personal computer's COM port using a 9-pin serial crossover (null modem) cable. Only the TXD, RXD, and ground pins need to be connected:

7330 RS232-1 DE9P DTE	Personal Computer DE9P
Pin 3, TXD	Pin 2, RXD
Pin 2, RXD	Pin 3, TXD
Pin 5, Ground	Pin 5, Ground

## Terminal Emulator

There are a number of common terminal emulators in use on the various operating systems.

For Windows, terminal emulators *TeraTerm (Original)*, *PuTTY* and *HyperTerm* are being used with the 7330:

TeraTerm (Original)	<a href="http://tssh2.sourceforge.jp/index.html.en">http://tssh2.sourceforge.jp/index.html.en</a>
PuTTY	<a href="http://www.putty.org">http://www.putty.org</a>
HyperTerm	<a href="http://www.hilgraeve.com/hyperterminal/">http://www.hilgraeve.com/hyperterminal/</a>

On *Linux*, owners are using *minicom* with *lrzsz* for file transfers.

For the *Mac*, [ZTerm](#) is a popular terminal emulator.

For other operating systems, choose an appropriate terminal program.

To use the front panel command (see page 8-15), your terminal emulator must support VT100 emulation.

For all terminal emulators, set the terminal emulator parameters as follows:

Parameter	Value
Baud Rate	57,600
Data Bits	8
Parity	None
Stop Bits	1
Delay-Per-Character	See table
Delay-Per-Line	100 milliseconds
Flow Control	None

Also, select the appropriate *Delay-Per-Character* value for your baud rate (see *notes below*):

Baud Rate	Delay-Per-Character Value	Delay-Per-Line Value
1200	0 milliseconds	50 milliseconds
2400	0 milliseconds	50 milliseconds
4800	0 milliseconds	50 milliseconds
9600	0 milliseconds	50 milliseconds
19,200	2 milliseconds ( <i>See Note 1</i> )	50 milliseconds
38,400	4 milliseconds ( <i>See Note 1</i> )	50 milliseconds
57,600	6 milliseconds ( <i>See Note 1</i> )	50 milliseconds

---

**Note 1:** Set the Delay-Per-Character value to zero when performing XModem transfers of firmware and configuration files. This will speed up the transfers.

**Note 2:** If you will be sending commands to the 7330 Repeater firmware from a text file, it's very important to set the *Delay-Per-Character* and *Delay-Per-Line* values as shown in the tables above. If you don't do this, the controller will not properly interpret commands that are sent. When this happens, you'll see the following error message: `Error: Serial input overflow or receive error.`

---

---

---

## Reset Console Defaults

This command resets the console and auxiliary port configurations back to the factory default settings.

- The factory default settings are shown on page 8-2.
  - This command is useful when you've forgotten, or never knew, the serial port settings for your controller. You can enter this command as DTMF from any port.
  - Enter the password and the 4-digit root number.
- 
- 

### Command Form:

Command	Form
Reset Console Defaults	(PW) 95 30 *

**Acknowledgment:** Sends *OK* message

### Errors:

Error	Meaning
? err 1	wrong number of digits entered
? err 2	illegal digit entered

**Default:** None

### Examples:

To reset the serial port defaults on your controller, enter the command:

```
(PW) 95 30 *
```

## Using the Console Port

The Console port has a number of different uses and sets of commands depending on what firmware is running in the 7330 Controller. By default, the 7330 Repeater firmware is controlling the radio equipment attached to the controller. Management firmware installed in the controller, called *SBOOT*, allows you to manage the files stored in the flash memory of the controller.

---

**Note:** SBOOT stands for S-COM Boot Manager. This tool is described starting on page 8-14.

---

When power is first applied to the controller, the firmware outputs the following message on the Console port:

```
S-COM 7330 Repeater V3.5.0
```

This message tells you what firmware is running and its version. In the above example the version is 3.5.0.

The startup routine of the firmware checks the condition of the controller's internal coin cell battery on every reset of the controller and reports its status:

```
Internal Battery: OK
```

or:

```
Internal Battery: Low
```

If the firmware is starting as a result of a *Cold Start* (see page 2-6), the 7330 Repeater firmware will confirm that it changed your active configuration to factory defaults by sending this message:

```
Cold Reset
```

If a mismatch is discovered between the 7330 Repeater firmware and SBOOT firmware that would cause improper operation, an error message is displayed:

```
Error: Mismatched firmware versions! Must fix now!
```

When the firmware is ready for you to type a command, it outputs the 7330 Repeater prompt:

```
7330>
```

So, the startup screen looks like this on a Warm Start:

```
S-COM 7330 Repeater V3.5.0
```

```
Cold Reset
```

```
Internal Battery: OK
```

```
7330>
```

and like this on other resets:

```
S-COM 7330 Repeater V3.5.0
```

```
Internal Battery: OK
```

```
7330>
```

---

## Entering Commands

You enter commands to the 7330 Repeater firmware on the Console port by typing an ASCII command or a DTMF-compatible command on a single line and then pressing `Enter`. (See the next section for definitions and command formats.)

A command response is returned as described below.

If you make an error while entering a command, press `Backspace` to erase one or more of the previous characters, or press `Control-C` to erase the entire line.

## Command Responses

The 7330 Repeater firmware outputs a command response as a text message for each command you enter. For DTMF-compatible commands, the command response is the text version of what you would hear as a CW or speech response message from the controller when you entered a command via a DTMF decoder:

CW Response	Serial Port Response
OK	OK
? err 1	Error: Wrong number of digits
? err 2	Error: Incorrect digits
? not found	Error: Macro name not found
? dir full	Error: Macro directory full
? too big	Error: Macro exceeds 200 digits
? name used	Error: Macro name already exists
? last	Error: Macro, cannot delete last command
	Error: Line too long
	Error: Invalid DTMF character
	Error: Serial input overflow or receive error

## Audio Responses

If the command you enter on the console causes an audio message to be played, that message is played on transmitter #1.

---

**Note:** Currently, the console DTMF commands to list the contents of macros are played as CW or speech to transmitter #1 (see page 5-14).

---



## Controller Command Format

There are two types of commands supported by the 7330 Repeater firmware. ASCII commands implement functions only available via the serial port. DTMF-compatible commands can be entered either on the serial port or a radio port via the DTMF buttons on your radio.

### ASCII Commands

The following ASCII commands are implemented in the 7330 Repeater firmware. Both upper case and lower case characters are accepted.

Command	Description
help	Display a list of the available commands.
ver	Displays the version of the 7330 Repeater firmware.
sboot	Stops the 7330 Repeater firmware and begins execution of the SBOOT utility. This utility allows configuration of the serial ports and provides file management facilities.
set name	Assigns a name to this controller that is displayed at Console command prompts.
fp	Display a remote front panel on your console.

The `help` command displays a list of the commands available:

```
Available commands:
  help
  ver
  sboot
  set name
  fp
  <dtmf commands>
```

The `ver` command displays the name and version of the 7330 Repeater firmware:

```
S-COM 7330 Repeater V3.5.0
```

The `sboot` command is used to manage the files stored in the flash memory of the controller. (See the *File Management* section later in this chapter.) The `sboot` command causes the 7330 Repeater firmware to temporarily stop executing and the SBOOT utility to execute instead.

The `set name` command assigns a name to this controller. This name shows up at the Console prompt. For example, if this controller is used at your Conifer repeater site, you can assign it that name:

```
7330>set name Conifer
Conifer:7330>
```

The `fp` command displays the current status of the LEDs on the front panel of the controller (except the power LED). Additional information is shown. (See *Remote Front Panel* section later in this chapter).

## DTMF-Compatible Commands

DTMF-compatible commands are sequences of digits that represent valid instructions for the controller that are also valid when entered via DTMF. Each command is entered on one line and ends with `Enter` (also known as a CR/LF):

```
994501000*(Enter)
```

The asterisk that normally ends a DTMF command is optional for serial commands when no comment follows the command on the same line:

```
994501000(Enter)
```

A command may optionally begin with an exclamation point (!). Accepting an exclamation point makes the command line compatible with the *TKDAB* format:

```
!994501000(Enter)
```

To execute a macro, type the macro's name, the optional asterisk, then press `Enter`:

```
6500*(Enter)
```

## Spaces

Any number of spaces or tabs may be inserted in commands or comments to make them more readable. The spaces and tabs are ignored:

```
99 45 0100 0 *(Enter)
```

## Comments

Comments begin with a semicolon (;) and can be placed on a line by themselves:

```
; TX1 Identifier Message Interval (Enter)
```

or at the end of lines containing commands:

```
99 09 2106 570 * ; 9.5 Minutes/570 seconds (Enter)
```

When a comment is on the same line as the command, the asterisk terminating the command is optional.

## **Sending a Prewritten Text File of Commands to the 7330**

To make it easier to manage the programming of your controller, you can type your commands and comments into a text file using a text editor like *Notepad* on *Windows*™. Then, you can use the Send Text File feature of your terminal emulator to send this file to the controller.

Before sending your file to the controller, be sure to set up the terminal emulator serial port configuration and delay parameters. (See the Terminal Emulator section earlier in this chapter.) By configuring these parameters, you will ensure that the commands will be properly recognized by the controller.

The feature of the terminal emulator you will use to send your file is the Send Text File feature. Each terminal emulator has this command, though it might work slightly differently or be named slightly differently in each one. Check the manual for your terminal emulator for specifics.

When you send the file of commands to the controller, each command is executed by the controller as it is received and a response is immediately sent. This will continue for each of the commands that you typed into the file. Be sure to watch carefully for error messages.

---

**Tip:** If you get errors while loading a script, check the character and line delays you have configured in your terminal emulator (see page 8-7).

---

## Remote Front Panel

You run the `fp` (Front Panel) command to view the real-time status of your controller on your terminal emulator screen. If the screen becomes corrupted, you can press `r` to refresh the display. The display is continuously updated until you exit this command by pressing `ESC` or `ENTER` on your keyboard. Upon exit, the last update is left on the screen for reference. You cannot enter other console commands while the front panel command is executing.

To properly display the remote front panel, your terminal emulator must be configured to operate as a VT-100 terminal. All recommended terminal emulators support this mode (see page 8-7, above).

The display shows the same status as the LEDs on the front panel of the controller. It also shows path status. This status can be useful in monitoring and controlling your system. Here is a typical display:

```

                                Time Time Time Path1 Path2 Path3 Path1 Path2
Path3
COR CTCSS PTT ENC DTMF Out1 Out2 Out3 Actv Actv Actv Enabl Enabl
Enabl
Port1: - - - - - - - - - - - 1 - 1
Port2: - - - - - - - - - - - 1 1 1
Port3: - - D - - - - - - - - 1 - 1

LogicIn (1234) : -1--
LogicOut(1234 5678): ---- ----

A/D (123) : 0.0V 9.2V 0.0V

```

### Understanding the Display

The display is divided into sections. The displayed sections are Port/Path Status, Logic Inputs/Outputs, and A-to-D Converter Inputs.

Port/Path Status and Logic Inputs/Outputs display a status of:

Active	1	Display the numeral <code>1</code> on when active.
Inactive	-	Display a hyphen when not active.
Disabled	D	Display the letter <code>D</code> when disabled (when appropriate).

### Port Status

The status of the LEDs on the front panel of the controller are shown in the first five columns of the remote front panel display on the console:

```

COR CTCSS PTT ENC DTMF
Port1: 1 1 1 1 -
Port2: - - 1 - -
Port3: - - D - 1

```

In this example, you can see that COR, CTCSS, PTT, and the CTCSS Encoder LEDs are all lit on Port 1, the PTT LED is lit on Port 2, the DTMF LED is lit on Port 3, and the Port 3 PTT is disabled.

## Path Status

The remote front panel display on the console also shows path status information that doesn't show on the LEDs. The displayed path status includes Path Timeout booleans, Path Active booleans and Path Enable software switches.

```

      Time Time Time Path1 Path2 Path3 Path1 Path2 Path3
      Out1 Out2 Out3 Actv  Actv  Actv  Enabl Enabl Enabl
Port1: -   -   -   1    1    -    1    -    -
Port2: -   -   1   -    -    -    1    1    1
Port3: -   -   -   -    -    -    1    -    -

```

In this display, the row label (Port1, Port2, Port3) represents the end of the path; the column label represents the source of the path. In this example, there's a timeout on path RX3-to-TX2, activity on paths RX1-to-TX1 and RX2-to-TX1, and the following paths are enabled: RX1-to-TX1, RX1-to-TX2, RX1-to-TX3, RX2-to-TX2, and RX3-to-TX2.

## Logic Inputs and Outputs

Logic input and output LED status is shown:

```

LogicIn (1234)      : -1--
LogicOut(1234 5678): ---- 1---

```

In this example, logic input 2 and logic output 5 are lit.

## A-to-D Converter Inputs

The value of each A-to-D converter input is shown:

```

A/D (123) : 0.0V  9.2V  0.0V

```

In this example, A-to-D converter input number 2 reads 9.2 volts. The other two inputs read 0.0 volts.

Formatting of these fields is controlled by the scaling selected for each input. See chapter 16 for details.

## Polling Front Panel Status

Some users display repeater site status on a web page. A concise output from the controller is easier for the web page software to use to interpret the current status. This command was added for this purpose.

The current status of the controller inputs and outputs can be polled using the console command `fpp`. The current status is output to the console as a single line of comma-delimited text terminated with a Carriage Return and Line Feed, like this:

```
FP,0,3,3,4,8,3,45,1,1,1,0,0,0,0,0,0,0,1,1,1,0,0,0,0,0,0,1,1,
1,0,0,0,0,0,0,0,0,0,0,0,0,0,0,0,0,0,0,0,0,0,0,0,0,0,0,0,
0,0,0,0,0, 0.0 , 0.0 , 0.0
```

This table defines the fields of the status output on a 7330:

Field Name and Description	Value
String Identification	%P+
Version	%+
Number of Receivers	%+
Number of Transmitters	%+
Number of Logic Inputs	%+
Number of Logic Outputs	%+
Number of A2D Inputs	%+
Number of Fields Following	%7+
Path Rx1-Tx1 Enable	%+= Disabled, %+= Enabled
Path Rx2-Tx1 Enable	%+= Disabled, %+= Enabled
Path Rx3-Tx1 Enable	%+= Disabled, %+= Enabled
Path Rx1-Tx1 Active	%+= Not Active, %+= Active
Path Rx2-Tx1 Active	%+= Not Active, %+= Active
Path Rx3-Tx1 Active	%+= Not Active, %+= Active
Path Rx1-Tx1 Timeout	%+= Normal, %+= Timed Out
Path Rx2-Tx1 Timeout	%+= Normal, %+= Timed Out
Path Rx3-Tx1 Timeout	%+= Normal, %+= Timed Out
Path Rx1-Tx2 Enable	%+= Disabled, %+= Enabled
Path Rx2-Tx2 Enable	%+= Disabled, %+= Enabled
Path Rx3-Tx2 Enable	%+= Disabled, %+= Enabled
Path Rx1-Tx2 Active	%+= Not Active, %+= Active
Path Rx2-Tx2 Active	%+= Not Active, %+= Active
Path Rx3-Tx2 Active	%+= Not Active, %+= Active
Path Rx1-Tx2 Timeout	%+= Normal, %+= Timed Out
Path Rx2-Tx2 Timeout	%+= Normal, %+= Timed Out
Path Rx3-Tx2 Timeout	%+= Normal, %+= Timed Out

Path Rx1-Tx3 Enable	%D+= Disabled, %A+= Enabled
Path Rx2-Tx3 Enable	%D+= Disabled, %A+= Enabled
Path Rx3-Tx3 Enable	%D+= Disabled, %A+= Enabled
Path Rx1-Tx3 Active	%D+= Not Active, %A+= Active
Path Rx2-Tx3 Active	%D+= Not Active, %A+= Active
Path Rx3-Tx3 Active	%D+= Not Active, %A+= Active
Path Rx1-Tx3 Timeout	%D+= Normal, %A+= Timed Out
Path Rx2-Tx3 Timeout	%D+= Normal, %A+= Timed Out
Path Rx3-Tx3 Timeout	%D+= Normal, %A+= Timed Out
COR Rx1 Logic Input	%D+= Not Active, %A+= Active, %B+= Disabled
COR Rx2 Logic Input	%D+= Not Active, %A+= Active, %B+= Disabled
COR Rx3 Logic Input	%D+= Not Active, %A+= Active, %B+= Disabled
CTCSS Rx1 Logic Input	%D+= Not Active, %A+= Active, %B+= Disabled
CTCSS Rx2 Logic Input	%D+= Not Active, %A+= Active, %B+= Disabled
CTCSS Rx3 Logic Input	%D+= Not Active, %A+= Active, %B+= Disabled
PTT Tx1 Logic Output	%D+= Not Active, %A+= Active, %B+= Disabled
PTT Tx2 Logic Output	%D+= Not Active, %A+= Active, %B+= Disabled
PTT Tx3 Logic Output	%D+= Not Active, %A+= Active, %B+= Disabled
CTCSS Encode Tx1 Logic Output	%D+= Not Active, %A+= Active
CTCSS Encode Tx2 Logic Output	%D+= Not Active, %A+= Active
CTCSS Encode Tx3 Logic Output	%D+= Not Active, %A+= Active
DTMF Rx1 Active	%D+= No Digit, %A+= Digit Decoding
DTMF Rx2 Active	%D+= No Digit, %A+= Digit Decoding
DTMF Rx3 Active	%D+= No Digit, %A+= Digit Decoding
Logic Input 1	%D+= Not Asserted, %A+= Asserted
Logic Input 2	%D+= Not Asserted, %A+= Asserted
Logic Input 3	%D+= Not Asserted, %A+= Asserted
Logic Input 4	%D+= Not Asserted, %A+= Asserted
Logic Output 1	%D+= Not Asserted, %A+= Asserted
Logic Output 2	%D+= Not Asserted, %A+= Asserted
Logic Output 3	%D+= Not Asserted, %A+= Asserted
Logic Output 4	%D+= Not Asserted, %A+= Asserted
Logic Output 5	%D+= Not Asserted, %A+= Asserted
Logic Output 6	%D+= Not Asserted, %A+= Asserted
Logic Output 7	%D+= Not Asserted, %A+= Asserted
Logic Output 8	%D+= Not Asserted, %A+= Asserted
A2D Input 1	Voltage (see page 8-15)
A2D Input 2	Voltage (see page 8-15)
A2D Input 3	Voltage (see page 8-15)

## File Management

You run the `sboot` (S-COM Boot Manager) command at the serial console prompt to manage files in your controller. You can review current file versions, save and restore controller configurations, upload and download files, and configure the serial ports.

While the `sboot` command is running you will see these changes in the operation of the controller and attached radios:

- The 7330 Repeater firmware is no longer operating. The repeaters and other radios controlled by the controller appear to be dead. Scheduler setpoints will not be recognized and executed.
- The logic output state is maintained.
- The front panel LEDs scan quickly left-to-right to remind you that the repeaters are not operating.
- The command prompt changes to `SBOOT>` or `Name:SBOOT>`.

The SBOOT utility outputs the following menu. This is referred to as the Main Menu in the on-screen menu choices. You can redisplay this menu at any time by typing the help command, `h`, then pressing `enter`.

```
SCOM 7330 SBOOT V1.4

7330 Controller Storage Management

T - Show Time
Tmmddyhhmmssw - Set Time (w=0=Sunday)

S - Save Repeater Configuration
R - Restore Repeater Configuration

E - Erase Files
L - Load File from a PC to Flash
U - Upload File from Flash to a PC
D - Display Flash Directory

P - Set Baud Rate of Console Port
N - Set Baud Rate of Auxiliary Port
W - Set Console Port Number

B - Boot from Flash
X - Exit to 7330
H - Help

Time      : 05/26/14 11:43:53 Mon
Internal Battery: OK
Name:SBOOT>
```

You can return to the 7330 Repeater firmware by typing the exit command, `x`, then pressing `enter`.



## SBOOT Version

The first line of the help output display shows the name of the firmware and its version:

```
SCOM 7330 SBOOT V1.4
```

## Managing the Controller Time-of-Day Clock

The current time from the controller's clock is shown below the menu:

```
Time: 05/26/14 11:43:53 Sun
```

Verify that the time-of-day is correct. If the time needs to be changed, you can use the menu items:

```
T - Show Time  
Tmmddyhhmmssw - Set Time (w=0=Sunday)
```

to review the current time and to set the time-of-day clock. No spaces are allowed in the command.

## Managing the Controller Configuration

The menu items:

```
S - Save Repeater Configuration  
R - Restore Repeater Configuration
```

let you manage the configuration of the Repeater firmware. Up to four configurations can be saved to the controller's flash memory. By saving configurations to the controller's flash memory then using the restore command, you can select if you would like to return controller operation to a previously saved configuration.

For more information on these commands see Configuration Management later in this chapter.

## Managing Files

You can use the following menu items to manage the firmware that's installed in your controller's flash memory. (Flash memory is a type of nonvolatile memory device used in modern electronic devices.)

```
E - Erase Files
L - Load File from a PC to Flash
U - Upload File from Flash to a PC
D - Display Flash Directory
```

Step-by-step instructions for updating Firmware Files shown in the directory are available in a separate release-specific document, *Firmware Update*, that's included in the release package.

---

**Note:** The CD that you received with your new 7330 contains (among other things) the release package that was current at the time your 7330 was shipped. You can find the latest release package on the 7330 Firmware Upgrades page at the [S-COM web site](#).

---

## Displaying Firmware File Information

The *Display Flash Directory* command is the SBOOT command that you will use the most. With this command you can confirm the version of the files that are installed in your controller. You can also view the Serial Number of your controller.

```
Controller Information
Model Number   : 7330
Serial Number  : Proto2
Manufactured DT: 09/17/2009 06:55:54 Thu
Formatted DT   : 09/17/2009 06:54:58 Thu
Customer Name  : Dave's Beta

Firmware Files
Location      Name                Version  Date                Type
-----
SYSTEM       BootROM              1.2.0
SBOOT        7330_SBoot          1.5.0    1/16/2016           Program
MFG          No File
DIAG         7330_Diag           1.2.0    9/4/2009            Program
SCOM_A       7330                 3.5.0    1/16/2016           Program
SCOM_B       No File

Configuration Files
Location      Name                Version  Date                Type
-----
CONFIG_A     Active140611        6/11/14 09:27 Configuration
CONFIG_B     ColdReset140328     3/28/14 15:11 Configuration
CONFIG_C     No File
CONFIG_D     No File

Speech Files
Location      Name                Version  Date                Type
-----
LIB          SCOM Sp Lib Eng    1.2.0    5/8/2011            Speech Library
CUSTOM       SCOM Cust ALib     1.0.0    09/09/09 12:00     Custom Audio Library
```

## Erasing A File

The *Erase File* command prompts you to identify a file location to erase. Select from the list of locations:

```
Erase a File from Flash:
  Location      Description
0 - SBOOT      -- File Management Utility
1 - DIAG       -- Diagnostics
2 - SCOM_A     -- 7330 Repeater Controller
3 - LIB        -- Speech Library
4 - CUSTOM     -- Custom Audio Library
5 - CONFIG_A   -- Configuration A
6 - CONFIG_B   -- Configuration B
7 - CONFIG_C   -- Configuration C
8 - CONFIG_D   -- Configuration D
9 - Active Configuration
Q - Return to Main Menu
H - Redisplay these options
```

```
Enter File Erase Option> 2
```

```
Enter Y to Erase, N to Cancel> y
```

```
Erasing...Done.
SBOOT>
```

You are asked to select a location and to confirm the erase.

---

**Tip:** Erase of the Active Configuration (option 9) returns the controller configuration to factory default settings, just like a Cold Start operation does when you press both the INIT and RESET buttons (see page 2-7).

---

## Transfer a File to Controller Flash Storage from a PC

The *Load File* command prompts you to identify a storage location to store a file transferred from a PC. Select from the list of locations. Erase the location before the transfer.

Load a File to Flash from a PC:

	Location	Description
0 -	SBOOT	-- File Management Utility
1 -	DIAG	-- Diagnostics
2 -	SCOM_A	-- 7330 Repeater Controller
3 -	LIB	-- Speech Library
4 -	CUSTOM	-- Custom Audio Library
5 -	CONFIG_A	-- Configuration A
6 -	CONFIG_B	-- Configuration B
7 -	CONFIG_C	-- Configuration C
8 -	CONFIG_D	-- Configuration D
Q -	Return to Main Menu	
H -	Redisplay these options	

Enter File Load Option> 2

Enter Y to Load the File from a PC, N to Cancel> y

Transferring the File to Flash from a PC using XModem.  
Start XModem Send-CRC...Done  
SBOOT>

You are asked to select the location and confirm the load. In your terminal emulator, select the option to transfer a file using XModem Send with CRC checking.

---

**Tip:** In TeraTerm click File, Transfer, XModem, Send. Be sure to check the CRC button in the displayed file selection dialog box. In newer versions of TeraTerm, there is no CRC option; TeraTerm figures it out automatically.

---

At the successful completion of the transfer, the file is ready to be used.

## Configuring the Serial Ports

You can use the following menu items to configure the controller serial ports.

```
P - Set Baud Rate of Console Port
N - Set Baud Rate of Auxiliary Port
W - Set Console Port Number
```

See *Serial Port Configuration* earlier in this chapter for instructions for using these commands.

## Boot/Run a Program

You will use the following menu item to run or boot firmware installed in the controller.

```
B - Boot from Flash
```

When you type `b` then press Enter, you are presented with a list of choices:

```
Load and Execute a Program from Flash:
0 - SBOOT
1 - Diagnostics
2 - 7330 Repeater Controller
3 - 7330 Repeater Controller - Cold Start, Erase Your Programming
Q - Return to Main Menu
H - Redisplay these options
```

Selecting option 0 restarts SBOOT from the stored version. This command is used if a new version of SBOOT is loaded.

Selecting option 1 lets you run the 7330 Diagnostics firmware. This program is used to diagnose hardware issues with the controller. It is used primarily by factory personnel.

Selecting option 2 lets you run the 7330 Repeater firmware again using the active configuration stored in battery-backed memory.

Selecting option 3 is the same as performing a Cold Start sequence that erases your active configuration replacing it with factory defaults (see *Initializing the Controller* on page 2-7). The controller will report a Cold Start to the serial console as shown on page 8-9. It will not speak its version and cold reset message to port #1.

---

**Note:** Previous versions of the 7330 Repeater firmware spoke the version and cold start message to port #1 when booted from this menu. This was found to cause problems with some radios, so was removed in version 3.6.x. Since the cold start was initiated from the serial console, the cold start message is only displayed there. This change only affects cold starts initiated from this menu.

---

The Boot command checks the version of the Active Configuration for compatibility with SBOOT and the 7330 Repeater firmware. If there is a mismatch, this warning message is displayed:

```
WARNING: Incompatible Active Configuration, cannot Boot.
```

This can happen after a firmware upgrade.

## Battery Status

The status of the internal coin cell battery is important, since it protects any configuration changes that have not been saved to flash.

```
Internal Battery: OK
```

This status is also displayed after the reset of the controller and can be queried via a DTMF command and spoken as a message. See *Backup Battery Monitoring* on page 5-30 for more information.

## Other Warnings

If you have been instructed to install either of the AUX jumpers and haven't removed them, you will see one or both of the following warnings:

```
WARNING: AUX1 Jumper Installed. Must be removed for  
unattended repeater operation!
```

```
WARNING: AUX2 Jumper Installed. Must be removed for  
unattended repeater operation!
```

Be sure to remove and store these jumpers before leaving the repeater site or the 7330 Repeater firmware won't automatically run after a power failure!

---

**Tip:** One way to store an unused jumper is to install it on just a single pin. This leaves the option open and keeps the jumper available for future use.

---

## Configuration Management

The Configuration File Management commands in SBOOT can be used a number of ways. If you are familiar with programmable radios, think of the controller configuration as a codeplug. You can save up to five configurations (or codeplugs) right in the controller: the active configuration (the programming you entered into the controller) plus up to four saved configurations.

You can modify a saved configuration by erasing it, saving the active configuration to it or transferring a configuration file to it from your PC.

You can modify the active configuration by resetting the configuration to factory defaults (Cold Start) or by restoring a saved configuration to it.

You can also transfer a saved configuration to a computer. In addition, there's a PC-based utility that can be used to generate a configuration report file or to regenerate a source script from your configuration that you can edit and reload into the controller.

### What's it good for?

The obvious use for configuration files is to save a copy of your active configuration (the programming that is currently running in the controller) so that it doesn't have to be reentered after updating the controller firmware to a newer version. But there's many other uses.

- Using the Upload feature, you can transfer saved configuration files to a computer for safe keeping, emailing, report generation or controller cloning.
- If you support multiple controllers or have the need to make quick repairs, you can deliver an identically configured replacement controller in the amount of time it takes to transfer a configuration file into the controller. (Note: you still have to set jumpers and audio levels manually.)
- If you have a need for more than one controller with the same configuration, you can clone one controller's saved configuration to another controller by transferring the same configuration file to any number of controllers from your computer.
- If you keep a spare controller on your bench for training, experimentation and backup, you can test a new configuration on your bench controller, save it in that controller then transfer it to your PC. You can email the configuration file to someone else. You or someone else can load it into the operating controller at the repeater site. If you're replacing a failed controller, the backup controller can be preprogrammed with the

configuration for the controller being replaced. Up to four saved configurations can be stored.

- Do you have a need to reprogram your controller for special events like a marathon or an emergency response operation? You can very quickly enter a command on the console port to reload an alternate configuration then switch back to an original configuration later.
- Maybe you want to experiment with some new programming, but you're concerned that you may cause a problem with the current configuration of your controller? You can easily save a copy of your active configuration before making your changes. If you don't like your results, you can easily discard the changes by restoring your previous configuration. (On operating systems this is sometimes called creating a restore point.)

But that's not all. With the S-COM Configuration Utility running on a Windows computer, there's additional things you can do.

- If you are inheriting responsibility for a controller that was programmed by someone else, you can recover the active configuration of the controller **including the passwords**. The utility will generate a file in S-COM script format that you can then use to make changes to the controller programming. Once the changes are made, you can use the script to reprogram a controller reset to factory defaults.
- If you are interested in the ability to view the active configuration of your controller, you'll appreciate the Controller Configuration Report generated by the utility that shows you everything programmed into the controller's active configuration including how the inversion jumpers are set.
- If you having trouble getting your macros to work just right, or if you forget what you programmed into a macro, a Controller Configuration Report shows you every macro and what's programmed into it, including some macros that you probably programmed and forgot about that might be giving you trouble.

## Managing the Controller Configuration

There are a small number of SBOOT menu items used to manage controller configurations:

```
S - Save Repeater Configuration
R - Restore Repeater Configuration

E - Erase Files
L - Load File from a PC to Flash
U - Upload File from Flash to a PC
D - Display Flash Directory
```



## Displaying Stored Configurations

Enter the **D** (*Display Flash Directory*) command to list the configuration files stored in your controller. These are configurations that you previously saved or transferred here from your computer. Empty locations show **No File**. For each file, the location, name, and date stored is shown.

Configuration Files					
Location	Name	Version	Date	Type	
CONFIG_A	Active140611		6/11/14 09:27	Configuration	
CONFIG_B	ColdReset140328		3/28/14 15:11	Configuration	
CONFIG_C	No File				
CONFIG_D	No File				

## Saving Your Active Configuration

The **S** (*Save Repeater Configuration*) command prompts you to enter a storage location to save a snapshot of your controller's currently programmed and active configuration. Up to four configurations can be saved in your controller. Select a location that is empty. If none are empty, you will need to erase a location before or while saving.

Save the Controller Configuration to a Flash File:

```

      Location      Description
5 - CONFIG_A -- Configuration A
6 - CONFIG_B -- Configuration B
7 - CONFIG_C -- Configuration C
8 - CONFIG_D -- Configuration D
Q - Return to Main Menu
H - Redisplay these options

```

Enter File Option> 7

Enter Y to Save, N to Cancel> y

Enter the Filename for this Saved File: testConfig

Saving the Controller Configuration to Flash...Done.

SBOOT>

You are asked to confirm the save operation and enter a filename for your saved configuration. Filenames can contain up to 16 characters. No filename suffix is required.

The Save command checks the version of the Active Configuration for compatibility with SBOOT and the 7330 Repeater firmware. If there is a mismatch, this warning message is displayed:

```
WARNING: Incompatible Active Configuration, cannot Save.
```

This can happen after a firmware upgrade.

## Restoring A Saved Configuration

The `R` (*Restore Repeater Configuration*) command prompts you to identify a storage location to restore as your active configuration. Select from up to four saved configurations. Select a location that is not empty.

```
Restore a Controller Configuration from a Flash File:
```

```
      Location      Description
5 - CONFIG_A -- Configuration A
6 - CONFIG_B -- Configuration B
7 - CONFIG_C -- Configuration C
8 - CONFIG_D -- Configuration D
Q - Return to Main Menu
H - Redisplay these options
```

```
Enter File Option> 7
```

```
Enter Y to Restore, N to Cancel> y
```

```
Erase your Active Configuration Before the Restore?
```

```
Enter Y to Erase, N to Cancel> y
```

```
Erasing the Active Configuration...Done
```

```
Restoring a Controller Configuration from Flash...Done.
```

```
SBOOT>
```

You are asked to select a location, to confirm the restore operation and to confirm erasing your active configuration.

The Restore command checks the version of the Active Configuration for compatibility with SBOOT and the 7330 Repeater firmware. If there is a mismatch, this warning message is displayed:

```
WARNING: Incompatible Active Configuration, cannot
Restore.
```

This can happen after a firmware upgrade.

## Erasing A Saved Configuration

The **E** (*Erase File*) command prompts you to identify a storage location to erase. Select from up to four saved configurations.

```
Eraser a File from Flash:
      Location      Description
  5 - CONFIG_A -- Configuration A
  6 - CONFIG_B -- Configuration B
  7 - CONFIG_C -- Configuration C
  8 - CONFIG_D -- Configuration D
  Q - Return to Main Menu
  H - Redisplay these options

Enter File Erase Option> 7

Enter Y to Erase, N to Cancel> y

Erasing...Done.
SBOOT>
```

You are asked to select a location and to confirm the erase operation. No recovery of an erased configuration is possible.

## Transfer a File to Controller Flash Storage from a PC

The **L** (*Load File*) command prompts you to identify a storage location to store a file transferred from a PC. Select from up to four storage locations. Select a location that is empty.

```
Load a File to Flash from a PC:

      Location      Description
  5 - CONFIG_A -- Configuration A
  6 - CONFIG_B -- Configuration B
  7 - CONFIG_C -- Configuration C
  8 - CONFIG_D -- Configuration D
  Q - Return to Main Menu
  H - Redisplay these options

Enter File Load Option> 8

Enter Y to Load the File from a PC, N to Cancel> y

Transferring the File to Flash from a PC using XModem.
Start XModem Send-CRC...Done
SBOOT>
```

You are asked to select the location and confirm the load operation. In your terminal emulator, select the option to transfer a file using XModem Send with CRC checking.

---

**Tip:** In TeraTerm click File, Transfer, XModem, Send. Be sure to check the CRC button in the displayed file selection dialog box.

---

Note that transferring a file from your computer to one of the four configuration locations does not make it active. You will need to use the Restore Command to make the transferred file your active configuration.

### Transfer a File to a PC from Controller Flash Storage

The *Upload File* command prompts you to identify a storage location to transfer to a PC. Select from up to four storage locations. Select a location that is not empty.

```
Upload a File to a PC from a Flash File:
```

```
      Location      Description
5 - CONFIG_A -- Configuration A
6 - CONFIG_B -- Configuration B
7 - CONFIG_C -- Configuration C
8 - CONFIG_D -- Configuration D
Q - Return to Main Menu
H - Redisplay these options
```

```
Enter File Upload Option> 8
```

```
Enter Y to Upload the File to a PC, N to Cancel> y
```

```
Transferring the File to a PC from Flash using XModem.
Start XModem Receive-CRC...Done
SBOOT>
```

You are asked to select the location and confirm the transfer. In your terminal emulator, select the option to transfer a file using XModem Send with CRC checking.

---

**Tip:** In TeraTerm click File, Transfer, XModem, Receive. Be sure to check the CRC button in the displayed file selection dialog box.

---

## S-COM Configuration Utility

The S-COM Configuration Utility is a PC-based program that is used to process an S-COM Controller Configuration File. This utility has options to:

- Generate a Full Controller Configuration Report of all settings, including defaults, in the saved configuration file. This option is useful for backup, training and reference.
- Generate a script file containing all commands that were used to customize the saved configuration file. This script is designed to configure the controller starting with the controller Cold Start values. This option is useful for recovering (and restoring) the programming from a controller when the original programming file is not available.
- Generate a script file containing all commands that can be used to program the controller. Any commands that don't change controller values from factory defaults are generated as a comment for easy editing. This option is useful for recovering the programming from a controller when the original programming file is not available and extensive changes are planned.

### Running the Command

The Utility runs as a DOS command line (Windows Command Prompt) utility. The command accepts the following parameters:

```
Usage: [-{r|s|a}] <config file name>
       r = Generate a full report (default)
       s = Generate a script that sets all non-default values
       a = Generate a script with commented commands for setting all values
```

You specify the type of file you want to generate and the controller configuration file to use as input. The report or script is output to the screen. Using the DOS redirect operator, you can generate the report or script to a file.

For example, if I have a configuration file called `Conifer7330`, I can view a full report on my screen using the following command:

```
scomconfigutil -r Conifer7330
```

Since the `-r` option is the default, the following command is the same:

```
scomconfigutil Conifer7330
```

I can generate an abbreviated script on my screen using the following command:

```
scomconfigutil -s Conifer7330
```

And I can generate a full script on my screen using this command:

```
scomconfigutil -a Conifer7330
```

Using the DOS redirect operator, I can generate the report to a file called `Conifer7330_Report.txt` using this command:

```
scomconfigutil -r Conifer7330 > Conifer7330_Report.txt
```

## The Generated Report

The report generated by the utility from the controller configuration file describes all details about the controller including the default values of controller configuration values.

The samples below show an example of the commands for each section. The list is very long, so only a few commands are shown.

### Report Header

The report header describes the version of the utility, the report type, the date and time when the report was generated and the configuration file used to generate the report:

```
S-COM Configuration Utility, V1.0.0
Copyright 2014 S-COM, LLC. www.scomcontrollers.com All rights reserved
```

```
Option Selected: Generate a full report
```

```
Controller Configuration Report
  Report Generated Date-Time      : 06/17/14 07:45:50
  Configuration File Name        : Cold24_140427
  Configuration File Date-Time   : 4/27/14 16:32
```

### Controller Definition

The controller definition section describes the controller that generated this configuration file:

```
Controller Definition
  Controller Model                : 7330
  Controller Firmware Version    : 3.5.0
  Controller Cold Reset Date-Time : 5/15/14 07:16:12
  Configuration Version          : 0
  Number of Receivers            : 3
  Number of Transmitters         : 3
  Number of Password Digits      : 6
  Number of Macro Name Digits    : 4
  User-Defined Controller Name   : Conifer
  Original Customer Name         : Dave's Proto
  Controller Serial Number       : Protol
  Controller Model Number        : 7330
  Controller Manufacture Date-Time : 12/1/13 12:41:04
  Controller Format Date-Time     : 12/1/13 12:39:40
```

Most fields are self-explanatory. The *Controller Model* identifies the hardware and firmware that generated the configuration file. The *Controller Model Number* is the product ordered as entered during manufacturing of this controller. These fields may not be the same.

## File Versions

The file versions section describes the firmware, speech and configuration files stored in the controller at the time the active configuration was saved:

```
File Versions
  BootROM                : 1.2.0
  SBOOT                  : 1.5.0
  Diagnostics            : 1.2.0
  SCOM_A                  : 3.5.0
  SCOM_B                  : no file
  Speech Library Version  : 1.2.0
  Custom Audio Library Version : no file

  Configuration_A        : version not set
  Configuration_B        : version not set
  Configuration_C        : no file
  Configuration_D        : no file
```

## Serial Port Configuration

The serial port configuration section describes how the serial ports are configured:

```
Serial Port Configuration
  RS232-1: Console, 57600, 8 data bits, no parity, no flow control, no modem control
  RS232-2: Auxiliary, 9600, 8 data bits, no parity, no flow control, no modem control
```

## Jumper Configuration

The jumper configuration section describes how the inversion and AUX jumpers are set in the controller:

```
Inversion Jumpers:
  COR1 = In/Active-High   COR2 = In/Active-High   COR3 = Out/Active-Low
  CTCSS1 = Out/Active-Low CTCSS2 = Out/Active-Low   CTCSS3 = Out/Active-Low
  PTT1 = Out/Active-Low  PTT2 = Out/Active-Low   PTT3 = Out/Active-Low
```

```
AUX Jumpers:
  AUX1 = Out   AUX2 = Out   AUX3 = Out   AUX4 = Out   AUX5 = Out
```

The settings of jumpers in the controller not listed here cannot be read and stored in the configuration file.

## Passwords

The passwords are displayed as plain text. If you will be sharing this file and you want to keep the password secure, you may want to edit the password text:

```
Passwords
  MPW : 99
  CPW :
  RBPW:
```

## Software Switches

All defined switches are shown in a table. The miscellaneous switches are shown first:

```
Software Switches
Miscellaneous Switches
No.   Set           Description
0000: 1 (Enabled ) -- Front Panel Enable
0001: 1 (Enabled ) -- Scheduler Enable
0002: 0 (Disabled) -- Daylight Saving Time (USA) Enable
0003: 0 (Disabled) -- Macro Erase Command Returns OK Enable
0004: 0 (Disabled) -- Macro-Only Password Decoding Enable
```

Then the port-specific switches are shown, one column for each port :

```
Port Switches
No.   Set           No.   Set           . . .   Description
0100: 1 (Enabled )   0200: 1 (Enabled )   . . .   -- DTMF Command Responses Enable
0101: 1 (Enabled )   0201: 1 (Enabled )   . . .   -- DTMF OK Command Responses Enable
0102: 1 (Enabled )   0202: 1 (Enabled )   . . .   -- DTMF Error Command Responses Enable
```

## Scheduler

All defined scheduler setpoints are shown including an interpretation of the setting:

```
Scheduler
Scheduler is Enabled
Setpoint 1 -- Enabled, Execute Macro A001 Every Month, Every Day, At 05:59
Setpoint 2 -- Enabled, Execute Macro A002 Every Month, On The 2nd Wednesday Of The
Month, At 23:55
Setpoint 3 -- Enabled, Execute Macro A003 Every Month, On The 3rd Wednesday Of The
Month, At 05:58
```

## Event-Triggered Macros

All defined event-triggered macros are shown in a table. The miscellaneous event-triggered macros are shown first:

```
Event-Triggered Macros
Miscellaneous ETMs
No.   Macro           Description
0000: ----         -- Power-On Reset Macro
0001: ----         -- Battery Good-to-Not-Good Macro
0061: ----         -- Logic Input 1 Hi-to-Lo Macro
0062: ----         -- Logic Input 1 Lo-to-Hi Macro
0063: ----         -- Logic Input 2 Hi-to-Lo Macro
```



Then the port-specific event-triggered macros are shown, one column for each port :

```
Port ETMs
No.      Macro  No.      Macro ) . . .      Description
0100:    ----  0200:    ) . . .      -- DTMF Decoder Any Long Tone Macro
0101:    ----  0201:    ---- ) . . .      -- DTMF Decoder Digit-Decoded Macro
0102:    ----  0202:    ---- ) . . .      -- Any-Path-Active To TXp Macro
0103:    ----  0203:    ---- ) . . .      -- All-Paths-Inactive To TX$d Macro
0104:    ----  0204:    ---- ) . . .      -- TXp Dropout Macro
```

## Messages

All defined messages are listed. The miscellaneous messages are shown first:

```
Messages
Miscellaneous Messages
Msg#  Contents                                     Description
0000: 9960 1352 0039 0005 0035 1550 9899 -- Warm Reset Command Response Message
0001: 9900 24 20                                     -- OK Command Response Message
0002: 9900 39 40 14 27 27 40 01                   -- Error 1 (Digit Count Error) Command Respon...
0003: 9900 39 40 14 27 27 40 02                   -- Error 2 (Data Error) Command Response Mess...
0015: ----                                         -- User Message #1
```

Then the port-specific messages are listed:

```
Port 1 Messages
Msg#  Contents                                     Description
0100: 9910 74 12                                     -- Path 11 (RX1-TX1) Courtesy Message
0101: 9910 74 16                                     -- Path 21 (RX2-TX1) Courtesy Message
0102: 9910 74 19                                     -- Path 31 (RX3-TX1) Courtesy Message
0103: 9900 59 00 53 29 24                           -- Path 11 (RX1-TX1) Timeout Message
```

## Path Mode

```
Path Mode
Port 1 Path Mode
RX1-DTMF Mode: 1 -- Carrier Only
RX1-TX1 Mode: 1 -- Carrier Only
RX2-TX1 Mode: 1 -- Carrier Only
RX3-TX1 Mode: 1 -- Carrier Only
```

## Timers – 10ms

All defined 10 millisecond timers are listed. The miscellaneous timers are shown first:

```
Timers -- 10ms
Miscellaneous -- 10ms Timers
  No.   Set   Time      Description
0000:  50 ( 500 ms)  -- Logic Output #1 Momentary Time
0001:  50 ( 500 ms)  -- Logic Output #2 Momentary Time
0002:  50 ( 500 ms)  -- Logic Output #3 Momentary Time
0003:  50 ( 500 ms)  -- Logic Output #4 Momentary Time
0004:  50 ( 500 ms)  -- Logic Output #5 Momentary Time
```

Then the port-specific timers are listed, one port per column:

```
Port -- 10ms Timers
  No.   Set   Time      No.   Set   Time      . . . Description
0100:  50 ( 500 ms)  0200:  50 ( 500 ms)  . . . -- TXp Courtesy Delay
0101:  300 ( 3000 ms)  0201:  300 ( 3000 ms)  . . . -- TXp Dropout Delay
0102:  10 ( 100 ms)  0202:  10 ( 100 ms)  . . . -- TXp PTT Minimum Unkey Delay
0103:  25 ( 250 ms)  0203:  25 ( 250 ms)  . . . -- TXp Turn-On Message Delay Value
```

## Timers – 100ms

All defined 100 millisecond timers are listed. The miscellaneous timers are shown first:

```
Timers -- 100ms
Miscellaneous -- 100ms Timers
  No.   Set   Time      Description
None defined
```

Then the port-specific timers are listed, one port per column:

```
Port -- 100ms Timers
  No.   Set   Time      . . . Description
1100:  50 ( 5000 ms)  . . . -- Path 1p (RX1-TXp) Timeout Penalty Time Value
1101:  50 ( 5000 ms)  . . . -- Path 2p (RX2-TXp) Timeout Penalty Time Value
```

## Timers – 1 Second

All defined 1 second timers are listed. The miscellaneous timers are shown first:

```
Timers - 1 second
Miscellaneous - 1 second Timers
  No.   Set   Time      Description
None defined
```

Then the port-specific timers are listed, one port per column:

```
Port -- 1 second Timers
  No.   Set   Time       No.   Set   Time       Description
2100:  180 ( 180 sec) 2200:  180 ( 180 sec) . . . -- Path 1p (RX1-TXp) Timeout Value
2101:  180 ( 180 sec) 2201:  180 ( 180 sec) . . . -- Path 2p (RX2-TXp) Timeout Value
2102:  180 ( 180 sec) 2202:  180 ( 180 sec) . . . -- Path 3p (RX3-TXp) Timeout Value
```

## Counter Reload Values

All defined counters are listed. The miscellaneous counters are shown first:

```
Counter Reload Values
Miscellaneous Counters
  No. Set           Description
None defined
```

Then the port-specific counters are listed, one port per column:

```
Port Counters
  No.   Set   No.   Set   No.   Set   Description
0100:   0   0200:   0   0300:   0   -- TXp End-of-Activity Counter
0101:   0   0201:   0   0301:   0   -- Path 1p End-of-Activity Counter
0102:   0   0202:   0   0302:   0   -- Path 2p End-of-Activity Counter
0103:   0   0203:   0   0303:   0   -- Path 3p End-of-Activity Counter
```

## Path Priority

```
Path Priority
Receivers Priority to Port 1 : none
Receivers Mixed to Port 1   : 1 2 3
Receivers Priority to Port 2 : none
Receivers Mixed to Port 2   : 1 2 3
Receivers Priority to Port 3 : none
Receivers Mixed to Port 3   : 1 2 3
```

## CTCSS Encoders

```
CTCSS Encoders
CTCSS Encoder Port 1
  Tone Number : 26 -- 100.0 Hz
  Mode        : 0  -- OFF
  Reverse Burst: 0  -- OFF
Notes:
CTCSS On Time, see Timer 0115.
CTCSS Reverse Burst Time, see Timer 0116.
CTCSS Inactive-to-Active Macros, see ETM number 0111.
CTCSS Active-to-Inactive Macros, see ETM number 0112.
CTCSS Encoder Controls Logic Output, Software Switch number 0117.
```

## ID Tail Message Number

```
ID Tail Message Number
Port 1
  Initial ID Tail: None
  Normal ID Tail: None
```

## Message Handler

The message handler parameters are shown in this section. First, the Owner-Fixed Frequency Beeps are defined:

```
Message Handler
Owner-Fixed Frequency Single-Tone and Dual-Tone Beeps
      Tone Code  Frequency
Beep Code 48:  0048 ( 500 Hz)
Beep Code 49:  0098 ( 750 Hz)
Beep Code 50:  0148 (1000 Hz)
Beep Code 51:  0198 (1250 Hz)
Beep Code 52:  0248 (1500 Hz)
Beep Code 53:  0298 (1750 Hz)
```

The following section shows parameters for each message:

Message Handler	TX1	TX2	Description
CW			
Speed	: 6 ( 5 WPM)	6 ( 5 WPM)	. . . -- Select CW Speed
Frequency	: 0248 ( 1500 Hz)	0248 ( 1500 Hz)	. . . -- Select CW Frequency
Level	: 12 ( -6.0 dB)	12 ( -6.0 dB)	. . . -- Select CW Level
Beep, Both Single-Tone and Dual-Tone			
Duration	: 06 ( 60 ms)	06 ( 60 ms)	. . . -- Select Beep Duration
Gap	: 02 ( 20 ms)	02 ( 20 ms)	. . . -- Select Gap Duration

## DTMF Decoders

```
DTMF Decoders
Port 1
  DTMF Commands Execute on Digit Count: 4
```

## Control Operator Privilege Level

```
Control Operator Privilege Level
Commands by Root Number
  Command 02: Enabled -- Control CTCSS Encoder
  Command 03: Enabled -- Select Frequency of CTCSS Encoder
  Command 06: Enabled -- Select Frequency of CW and Single-Tone Beeps
```

## User Timers

```
User Timers
User Timer 0
  Enable      : Disabled
  Timeout Value: 10 ( 1.0 sec)
  Timeout Macro: ----
```

## Macros

### Macros

```
Name: B001
  Location   : 217
  Commands  :
    B002 *           -- Execute Macro
    MPW 15 9720 9960 7105 3000 7105 9999 B003 * -- Send Message
    9294 *           -- Execute Macro
```

## Tone Generators

### Tone Generators

```
Tone Generator Port 1
  Owner      : Message Handler
  Mode       : Off
  Message Level: 0, 0.0 dB
  ToneCode   : 0000, 260 Hz

Tone Generator Port 2
  Owner      : Message Handler
  Mode       : Off
  Message Level: 0, 0.0 dB
  ToneCode   : 0000, 260 Hz

Tone Generator Port 3
  Owner      : Message Handler
  Mode       : Off
  Message Level: 0, 0.0 dB
  ToneCode   : 0000, 260 Hz
```

## Long Names

### Long Names

```
Long Name 0
  Enable    : Disabled
  Ports     : None
  Macro     : Not Set
  Long Name: Not Set
```

## The Generated Script

The script generated by the utility from the controller configuration file creates the commands required to program the controller starting from Cold Start factory defaults. When the option is specified to generate all commands and configuration values are set to defaults, commands are generated as comments that can be edited to create additional programming commands.

The samples below show an example of the commands for each section. The list is very long, so only a few commands are shown.

### Script Header

The report header describes the version of the utility, the report type, when the report was generated and the configuration file used to generate the report:

```
;;S-COM Configuration Utility, V1.0.0
;Copyright 2014 S-COM, LLC. www.scomcontrollers.com All rights reserved
;
;Option Selected: Generate a script with commented commands for setting all values
;
;S-COM Programming Script Generated From:
; Script Generated Date-Time      : 06/17/14 07:45:50
; Configuration File Name        : Cold24_140427
; Configuration File Date-Time   : 4/27/14 16:32
```

### Controller Definition

The controller definition section describes the controller that generated this configuration file:

```
;Controller Definition
; Controller Model                : 7330
; Controller Firmware Version     : 3.5.0
; Controller Cold Reset Date-Time : 5/15/14 07:16:12
; Configuration Version          : 0
; User-Defined Controller Name    : Conifer
; Original Customer Name         : Dave's Proto
; Controller Serial Number       : Protol
; Controller Model Number        : 7330
; Controller Manufacture Date-Time : 12/1/13 12:41:04
; Controller Format Date-Time     : 12/1/13 12:39:40
```

Most fields are self-explanatory. The *Controller Model* identifies the hardware and firmware that generated the configuration file. The *Controller Model Number* is the product ordered as entered during manufacturing of this controller. These fields may not be the same.

## Jumper Configuration

The jumper configuration section describes how the inversion and AUX jumpers are set in the controller:

```
;Inversion Jumpers:
; COR1 = In/Active-High      COR2 = In/Active-High      COR3 = Out/Active-Low
; CTCSS1 = Out/Active-Low    CTCSS2 = Out/Active-Low    CTCSS3 = Out/Active-Low
; PTT1 = Out/Active-Low     PTT2 = Out/Active-Low     PTT3 = Out/Active-Low
;
;AUX Jumpers:
; AUX1 = Out  AUX2 = Out  AUX3 = Out  AUX4 = Out  AUX5 = Out
```

The settings of jumpers in the controller not listed here cannot be read and stored in the configuration file.

## Passwords

The passwords are displayed as the acronyms MPW or CPW.:

```
; Define Passwords
; Set MPW
;99 93 MPW *                               ; Assign Master Password
; Set CPW
;MPW 92 CPW *                             ; Assign Control Operator Password
```

## Software Switches

```
; Set Software Switches
; Miscellaneous Switches
;MPW 63 0000 1 *                           ; 1 (Enabled, Front Panel Enable
;MPW 63 0001 1 *                           ; 1 (Enabled, Scheduler Enable
;MPW 63 0002 0 *                           ; 0 (Disabled, Daylight Saving Time (USA) Enable
;MPW 63 0003 0 *                           ; 0 (Disabled, Macro Erase Command Returns OK Enable
```

## Scheduler

```
; Set Scheduler Setpoints
; Set Setpoint 29
;MPW 28 29 xxxx yy dd hh mm *             ; Create a Setpoint
;MPW 28 29 1 *                             ; Enabled, Enable/Disable Setpoint

; Set Setpoint 35
; Execute Macro A001 Every Month, On The 2nd Wednesday Of The Month, At 23:55
MPW 28 02 A001 99 50 23 55 *             ; Create a Setpoint
MPW 28 02 1 *                             ; Enabled , Enable/Disable Setpoint
```

## Event-Triggered Macros

```

; Set Event-Triggered Macros
; Miscellaneous ETMs
;MPW 26 0000 <macroname> * ; Power-On Reset Macro
;MPW 26 0001 <macroname> * ; Battery Good-to-Not-Good Macro
;MPW 26 0061 <macroname> * ; Logic Input 1 Hi-to-Lo Macro
;MPW 26 0062 <macroname> * ; Logic Input 1 Lo-to-Hi Macro

```

## Messages

```

; Define Messages
;; Miscellaneous Messages
MPW 31 0000 9960 1352 0039 0005 0035 1550 9899 * ; Warm Reset Command Response Message
MPW 31 0001 9900 24 20 * ; OK Command Response Message
MPW 31 0002 9900 39 40 14 27 27 40 01 * ; Error 1 (Digit Count Error) Command ...
MPW 31 0003 9900 39 40 14 27 27 40 02 * ; Error 2 (Data Error) Command Respon ...
MPW 31 0015 <message> * ; User Message #1
MPW 31 0016 <message> * ; User Message #2

```

## Path Mode

```

; Set Path Mode
; Port 1 Path Mode
MPW 57 1 1 * ; RX1-DTMF, Carrier Only
MPW 57 11 1 * ; RX1-TX1, Carrier Only
MPW 57 21 1 * ; RX2-TX1, Carrier Only
MPW 57 31 1 * ; RX3-TX1, Carrier Only

```

## Timers – 10ms

```

; Port 1 -- 10ms Timers
;MPW 09 0100 50 * ; 500 ms, TX1 Courtesy Delay
;MPW 09 0101 300 * ; 3000 ms, TX1 Dropout Delay
MPW 09 0102 10 * ; 180 ms, TX1 PTT Minimum Unkey Delay
;MPW 09 0103 25 * ; 250 ms, TX1 Turn-On Message Delay Value

```

## Timers – 100ms

```

; Port 1 -- 100ms Timers
;MPW 09 1100 50 * ; 5000 ms, Path 11 (RX1-TX1) Timeout Penalty Time Value
;MPW 09 1101 50 * ; 5000 ms, Path 21 (RX2-TX1) Timeout Penalty Time Value
;MPW 09 1102 50 * ; 5000 ms, Path 31 (RX3-TX1) Timeout Penalty Time Value
;MPW 09 1103 30 * ; 3000 ms, DTMF Decoder #1 Long Tone Timer

```

## Timers – 1 Second

```

; Port 1 -- 1 second Timers
;MPW 09 2100 180 * ; 180 seconds, Path 11 (RX1-TX1) Timeout Value
MPW 09 2101 45 * ; 45 seconds, Path 21 (RX2-TX1) Timeout Value
;MPW 09 2102 180 * ; 180 seconds, Path 31 (RX3-TX1) Timeout Value
;MPW 09 2103 60 * ; 60 seconds, Path 11 End-of-Activity Time Value

```



## Counter Reload Values

```

; Port 2 Counters
;MPW 45 0200      0 *           ; TX2 End-of-Activity Counter
MPW 45 0201      5 *           ; Path 12 End-of-Activity Counter
;MPW 45 0202      0 *           ; Path 22 End-of-Activity Counter

```

## Path Priority

```

; Set Path Priority
; Receiver Priority to Port 1 : none
; Receiver Mixed to Port 1   : 1 2 3

```

## CTCSS Encoders

```

; Set CTCSS Encoders
; CTCSS Encoder Port #1
; Tone Number   = 26 (100.0 Hz)
; Mode          = 1 (Follow PTT, Turn OFF Before Minimum Unkey Delay)
; Reverse Burst = 2 (180-degree)
;MPW 03 1 26 *           ; Set Tone Number (CTCSS Frequency)
MPW 02 1 1 2 *           ; Set Mode and Reverse Burst Enable
; Notes:
; CTCSS On Time, See Timer 0115.
; CTCSS Reverse Burst Time, See Timer 0116.
; CTCSS Inactive-to-Active Macros, See ETM number 0111.
; CTCSS Active-to-Inactive Macros, See ETM number 0112.
; CTCSS Encoder Controls Logic Output, Software Switch Number 0117.
; CTCSS Encoder/Logic Output Jumper, J37.

```

## ID Tail Message Number

```

; Set ID Tail Message Number
; ID Tail Message Number Port 1
; Initial ID Tail Message Number: None
; Normal ID Tail Message Number : None

```

## Message Handler

```

; Message Handler Port 2
; CW
;MPW 12 20 6 *           ; TX2, 20 wpm, Select CW Speed
;MPW 06 20 0248 *        ; TX2, 1500 Hz, Select CW Frequency
;MPW 10 0200 12 *        ; TX2, -6.0 dB, Select CW Level

```

## DTMF Decoders

```

; Set DTMF Decoders
; Port 1
; DTMF Commands Execute on Digit Count: 4

```

## Control Operator Privilege Level

```
; Set Control Operator Privilege Level
;MPW 94 02 0 *           ; Enabled, Control CTCSS Encoder
;MPW 94 03 0 *           ; Enabled, Select Frequency of CTCSS Encoder
;MPW 94 06 0 *           ; Enabled, Select Frequency of CW and Single-Tone Beeps
;MPW 94 08 0 *           ; Enabled, Select Default Tone and Gap Durations
```

## User Timers

```
; Set User Timers
;MPW 49 00 03 10 *           ; 1.0 seconds, Set User Timer #0 Value
;MPW 49 00 02 <macroname> * ; Set Macro For User Timer #0
MPW 49 01 03 1800 *         ; 180.0 seconds, Set User Timer #1 Value
MPW 49 01 02 1234 *         ; Set Macro For User Timer #1
```

## Macros

```
; Set Macros
; Macro Name = B001, Macro Directory Location = 196
MPW 20 B001 A210 *           ; Execute Macro
MPW 29 B001 MPW 21 A212 *    ; Erase Macro
MPW 29 B001 A211 *           ; Execute Macro
```

## Tone Generators

```
; No Tone Generators Configured
```

## Long Names

```
MPW 46 06 00 0 *           ; Set Enable For Long Name 6
MPW 46 06 01 *             ; Set Long Name 6
MPW 46 06 02 *             ; Set Macro For Long Name 6
MPW 46 06 03 123 *         ; Set Port Access For Long Name 6
```

# Chapter 9

# Paths

Suppose two repeaters are operating side-by-side, in the same rack, on the same controller. Repeater #1 is in carrier access mode, has a three-minute timeout timer, and sends a single courtesy beep. Repeater #2 is in CTCSS access mode, has a five-minute timeout timer, and sends a dual courtesy beep. If the two systems operate independently, they're pretty simple to understand and set up properly.

But if we interconnect the repeaters so that both receivers feed each transmitter, some questions arise. When both receivers detect incoming signals, should both be retransmitted or just one? Can a receiver be carrier-accessed on one repeater and CTCSS-accessed on the other? Can a receiver have two different timeout timers depending on which transmitter it's driving? Can a transmitter send different courtesy beeps depending on which receiver fed it last so a listener knows the source of the audio?

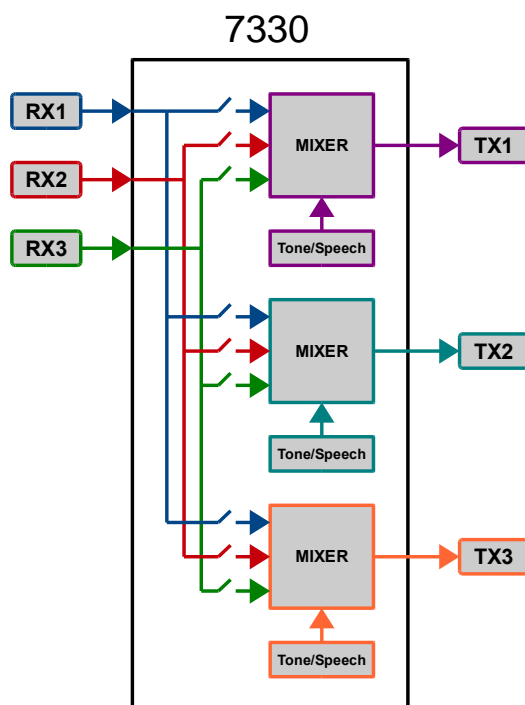

The 7330 easily handles these issues and more by supporting nine separate *paths*, each connecting one receiver to one transmitter. You can enable and disable the path, program the access mode, timeout timer, courtesy message, and other features of each path separately. You can also choose a priority/mixing scheme for the paths feeding each transmitter.

Let's go back to our example. With the 7330, the receiver-to-transmitter path that makes up repeater #1 can be in carrier access mode with a three-minute timeout timer and a single courtesy beep. The path that makes up repeater #2 can be in CTCSS access mode with a five-minute timeout timer and a dual courtesy beep. The path that connects receiver #1 to transmitter #2 can have its own access mode, priority, timeout timer, and courtesy message, and so can the path that connects receiver #2 to transmitter #1. Furthermore, the receivers can be either prioritized or mixed to each transmitter.

We've covered four paths so far: RX1-TX1, RX1-TX2, RX2-TX1, and RX2-TX2. Suppose we connect a simplex link transceiver to the 7330's third port. The 7330 will give us five more paths (RX3-TX1, RX3-TX2, RX3-TX3, RX1-TX3, and RX2-TX3), each with the same features as the other paths. That's good, because we'd want to do things like turn off the RX3-TX3 path. The link receivers have access to its own transmitter. Since a simplex transceiver can't receive and transmit at the same time, we'd probably eliminate transmitter #3's tail because removing the hang time speeds up the turnaround time on the link channel. More importantly, we can now separately program the way the link accesses the repeaters and vice-versa.

In short, path commands let you program the 7330 to handle any simplex or duplex combination of three receivers and three transmitters without the need for external port expanders and similar hardware.

Not all receiver and transmitter functions are associated with paths. Things like identification messages and dropout messages, for example, are associated with transmitters rather than paths and are discussed in other chapters.

For brevity, we can number each path using the receiver number followed by the transmitter number, like this:

RX TX

**Path**

1	2
---	---

In this example, the path from RX1 to TX2 is *path 12*.

## Path Enable/Disable Path Access Mode

These commands enable or disable and program the access mode for a receiver-to-transmitter path. It does not affect the access modes for receiver-to-DTMF decoder paths, which are discussed in the DTMF chapter.

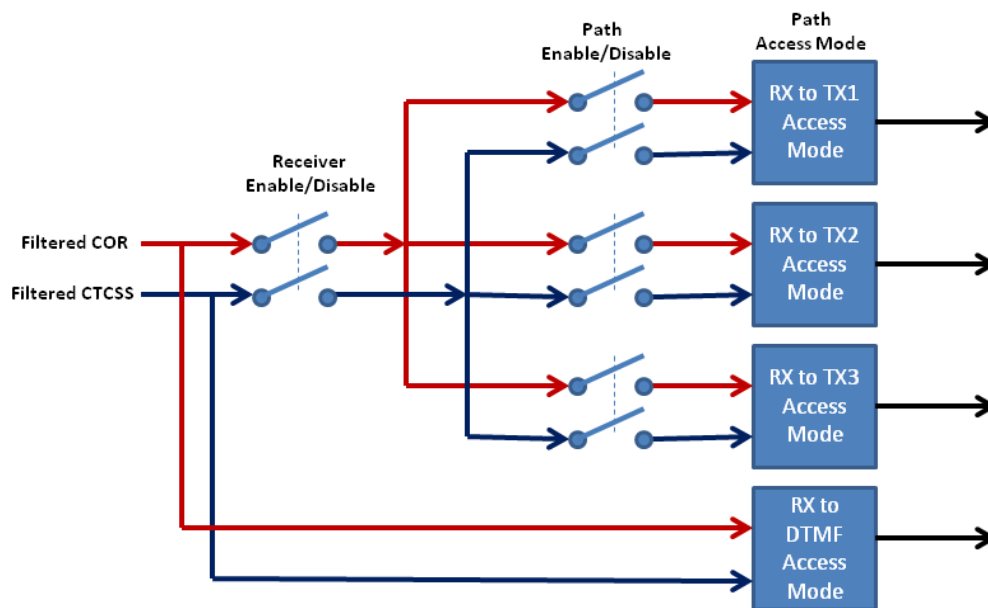

A receiver-to-transmitter path can be programmed so the transmitter is keyed none of the time, all of the time, or dependent on the receiver's COR and CTCSS inputs.

Selecting different access modes for different paths can be quite useful. For example, assume there are two repeater sites, each equipped with a 2M repeater with a CTCSS decoder, a 450 MHz link transceiver, and a 7330. You can program the 7330s so that the 2M receiver-to-2M transmitter path is in carrier access, and the 2M receiver-to-450 transmitter is in CTCSS access. That way, users who choose not to transmit CTCSS will have their conversations limited to just the local repeater. Users who transmit CTCSS can converse through both repeaters because their CTCSS tone will bring up the link transmitter.

---

**Note:** If more than one path to a transmitter is active, the controller selects which path(s) feed(s) the transmitter based on the priority/mix scheme you've chosen. See the *Select Path Priority* command.

---

### Example Uses

Here are some practical uses for the seven path access modes:

In **Access Mode 0 (No Access)**, the path is disabled and the receiver does not key the transmitter. The COR and CTCSS inputs are ignored.

If a simplex link transceiver is connected to RX3-TX3, for example, set path 33 to mode 0 to prevent an incoming signal on RX3 from keying TX3.

If a control receiver is connected to RX3, also set paths 31 and 32 to mode 0 to prevent DTMF commands from being retransmitted by the other ports.

In **Access Mode 1 (Carrier)**, the receiver COR input must be active to key the transmitter. The CTCSS input is ignored.

This is the normal mode for carrier-accessed repeaters. Even if your repeater is CTCSS-accessed, you may still want to have macro commands handy that put the repeater into carrier access and into CTCSS access. That way, the repeater can be operated in carrier access mode for testing purposes, for use by visitors during tourist season, and so on. Some repeaters allow temporary carrier access by DTMF command and use the end-of-activity macro to return the repeater to CTCSS access after the conversation ends.

In **Access Mode 2 (CTCSS)**, the CTCSS input must be active to key the transmitter. The COR input is ignored.

In **Access Mode 3 (Carrier AND CTCSS)**, both the COR and CTCSS inputs must be active to key the transmitter.

Both modes 2 and 3 limit access to CTCSS users. Mode 3 is usually the better choice because it requires not only CTCSS but also carrier (a CTCSS decoder can be falsed by adjacent-channel interference, so requiring a sufficiently strong signal to be present to open the COR minimizes falsing).

In **Access Mode 4 (Carrier OR CTCSS)**, either the COR input or the CTCSS input must be active to key the transmitter.

In mode 4, carrier users and CTCSS users both have access. Since CTCSS decoders are more sensitive than squelch circuits, CTCSS users may experience increased range. Carrier users do not see any difference between mode 1 (Carrier) and 4 (Carrier OR CTCSS). If you tighten the receiver squelch to suppress band opening problems, CTCSS users may find they have better access than carrier users.

In **Access Mode 5 (Anti-CTCSS)**, the COR input must be active and the CTCSS input must be inactive to key the transmitter.

This mode is helpful if your repeater is on the same channel as a CTCSS-accessed repeater. You can install a CTCSS decoder programmed to the other repeater's tone frequency. In mode 5, your repeater ignores the other system's users.

The COR Filter plays a role in this mode (see page 10-3). The CTCSS decoder is usually slower than the COR/squelch circuit. By setting the COR Filter time delay at least as long as your CTCSS decoder's turn-on delay, you'll make sure the controller won't respond to a COR signal until after the CTCSS decoder determines that there is no unwanted CTCSS tone accompanying it.

In **Access Mode 6 (Always ON)**, the receiver keys the transmitter continuously. The COR and CTCSS inputs are ignored.

Mode 6 can be a path simulate+troubleshooting tool because it sends receiver audio to the transmitter, and keeps the transmitter keyed, regardless of the COR and CTCSS inputs. Putting a path in mode 6 means you hear everything present on receiver audio. In that regard it works like the COR and CTCSS Simulate commands. But while the COR and CTCSS Simulate commands key multiple transmitters if the paths allow it, the Path Access Mode command affects only the receiver-to-transmitter path you are commanding. Keep in mind that other path parameters, like the Path Timeout Timer may need to be adjusted.

Another use for mode 6 is to feed, on command, audio from an external source (such as a Space Shuttle or weather radio feed) to a transmitter.

---



---

## Enable/Disable Path

Turns ON or OFF a specific path.

- Enabling or disabling a path does not change the programmed Path Access Mode for that path (see page 9-7).
  - Enter the password, the two-digit root number, the four-digit software switch number, and one digit (0 to disable the path, 1 to enable it).
- 
- 

### Command Form:

Command	Form	Data Digit
Enable/Disable RX1-TX1 Path	(PW) 63 0141 x *	0 = OFF (disabled) 1 = ON (enabled)
Enable/Disable RX2-TX1 Path	(PW) 63 0142 x *	
Enable/Disable RX3-TX1 Path	(PW) 63 0143 x *	
Enable/Disable RX1-TX2 Path	(PW) 63 0241 x *	
Enable/Disable RX2-TX2 Path	(PW) 63 0242 x *	
Enable/Disable RX3-TX2 Path	(PW) 63 0243 x *	
Enable/Disable RX1-TX3 Path	(PW) 63 0341 x *	
Enable/Disable RX2-TX3 Path	(PW) 63 0342 x *	
Enable/Disable RX3-TX3 Path	(PW) 63 0343 x *	

**Acknowledgment:** Sends OK message

### Errors:

Error	Meaning
? err 1	wrong number of digits entered
? err 2	illegal digit entered

**Default:** All Paths are ON (enabled)

### Examples:

To disable the RX1-TX2 path, enter:

(PW) 63 0241 0 \*

To enable it again, enter:

(PW) 63 0241 1 \*



## Select Path Access Mode

Selects the access mode for each receiver-to-transmitter path.

- Programming the Path Access Mode does not affect the Path Enable/Disable Software Switch (see page 9-6).
- Enter the password, the two-digit root number, the two-digit path number, and a one-digit mode number.

### Command Form:

Command	Form	Data Digit
Select RX1-TX1 Access Mode	(PW) 57 11 x *	(see table below)
Select RX2-TX1 Access Mode	(PW) 57 21 x *	
Select RX3-TX1 Access Mode	(PW) 57 31 x *	
Select RX1-TX2 Access Mode	(PW) 57 12 x *	
Select RX2-TX2 Access Mode	(PW) 57 22 x *	
Select RX3-TX2 Access Mode	(PW) 57 32 x *	
Select RX1-TX3 Access Mode	(PW) 57 13 x *	
Select RX2-TX3 Access Mode	(PW) 57 23 x *	
Select RX3-TX3 Access Mode	(PW) 57 33 x *	

### Path Access Modes:

Mode	Access	Explanation
0	No Access	The receiver does not key the transmitter.
1	Carrier	The receiver keys the transmitter when the COR input is active.
2	CTCSS	The receiver keys the transmitter when the CTCSS input is active.
3	Carrier AND CTCSS	The receiver keys the transmitter when both the COR input and the CTCSS input are active.
4	Carrier OR CTCSS	The receiver keys the transmitter when either the COR input or the CTCSS input is active.
5	Anti-CTCSS	The receiver keys the transmitter when the COR input is active and the CTCSS input is inactive.
6	Always On	The receiver keys the transmitter regardless of the COR input and the CTCSS input.

**Acknowledgment:** Sends OK message

### Errors:

Error	Meaning
? err 1	wrong number of digits entered
? err 2	illegal digit entered

**Default:** All paths are in access mode 1 (Carrier).

**Example: Configure Receiver Paths to a Transmitter**

For this example, we have a repeater on port 1 linked full-time to a wired link on port 2. Port 3 has a control receiver which is not linked to the other two ports. Here's the commands to set this up:

The RX1 to TX1 path is the repeater audio path with COR and CTCSS, so we set path 11 to Access Mode 3 (Carrier AND CTCSS). Enter:

```
(PW) 57 11 3 *
```

The RX1 to TX2 path is the audio path to the wired link with COR and CTCSS, so we set path 12 to Access Mode 3 (Carrier AND CTCSS). Enter:

```
(PW) 57 12 3 *
```

The RX1 to TX3 path is turned off since there's no transmitter on port 3, so we set path 13 to Access Mode 0 (No Access). Enter:

```
(PW) 57 13 0 *
```

The RX2 to TX1 path is the audio path from the wired link to the repeater transmitter, so we set path 21 to Access Mode 1 (Carrier). Enter:

```
(PW) 57 21 1 *
```

The RX2 to TX2 path is turned off since this is a link port, not a repeater, so we set path 22 to Access Mode 0 (No Access). Enter:

```
(PW) 57 22 0 *
```

The RX2 to TX3 path is turned off since there's no transmitter on port 3, so we set path 23 to Access Mode 0 (No Access). Enter:

```
(PW) 57 23 0 *
```

The RX3 to TX1 path is turned off since RX3 is a control receiver, so we set path 31 to Access Mode 0 (No Access). Enter:

```
(PW) 57 31 0 *
```

The RX3 to TX2 path is turned off since RX3 is a control receiver, so we set path 32 to Access Mode 0 (No Access). Enter:

```
(PW) 57 32 0 *
```

The RX3 to TX3 path is turned off since RX3 is a control receiver, so we set path 33 to Access Mode 0 (No Access). Enter:

```
(PW) 57 33 0 *
```

## Path Priority

Multiple paths may be active to the same transmitter at the same time, so the 7330 lets you choose their priorities and/or allow them to mix.

Here's how it works. If more than one receiver is %active+ (meaning it meets the path access conditions needed to key a transmitter), the controller uses the priority/mix scheme you've specified with this command to decide which receiver(s) feeds the transmitter.

If a receiver becomes active and you've assigned a priority to it, its priority is checked against the other active receivers. The highest priority active receiver feeds the transmitter and the other receivers are muted. For example, if RX2 is feeding the transmitter when RX1 becomes active, and if RX1 has a higher priority than RX2, then RX2 is muted and RX1 feeds the transmitter.

If you haven't assigned a priority to a receiver, its priority is below any receiver with an assigned priority. It feeds a transmitter (and mixes with any other similarly lowest-priority receivers) only if there are no active higher-priority receivers.

Note that if you don't assign a priority to a receiver, that doesn't mean it can't access a transmitter. It's simply in last place in the priority scheme. If you want to turn off its access to a certain transmitter, use the Enable/Disable Path command or use the Select Path Access Mode command to put that path into Mode 0.

---



---

## Select Path Priority

Selects the priority of receivers feeding a transmitter when more than one receiver is active.

- Enter the password, the two-digit root number, the one-digit transmitter number, and the receiver numbers in the order of priority, highest first. Receivers not specified fall to lowest priority and are mixed.
- 
- 

### Command Form:

Command	Form	Data Digit
Select Priority of Receivers to TX1	(PW) 90 1 r r r *	1 = RX 1
Select Priority of Receivers to TX2	(PW) 90 2 r r r *	2 = RX 2
Select Priority of Receivers to TX3	(PW) 90 3 r r r *	3 = RX 3

**Acknowledgment:** Sends OK message

### Errors:

Error	Meaning
? err 1	wrong number of digits entered
? err 2	illegal digit entered

**Default:** No priority. All enabled paths are mixed to each transmitter.

### Examples:

For TX1: RX1 is the highest priority, followed by RX3, then RX2. Enter:

```
(PW) 90 1 1 3 2 *
```

For TX2: RX3 is the highest priority. RX1 and RX2 are mixed. Enter:

```
(PW) 90 2 3 *
```

For TX3: No priority. All three receivers are mixed. Enter:

```
(PW) 90 3 *
```

(% is the transmitter number. Since no receivers are listed, they are all mixed.)

## Introduction to Path Timeout Timers

The purpose of a timeout timer is to shut down a transmitter when it is continuously keyed for an excessively long time. Things that can cause timeouts include stuck microphone buttons, long-winded users, noise, and reception of distant signals due to unusual propagation conditions.

For maximum flexibility, the 7330's timeout timers don't monitor receivers or transmitters. They monitor the paths that connect them.

Why? Because if the timeout timer were to monitor a receiver, then an excessively long transmission would disconnect that receiver from all transmitters, RF links, Internet links, and other devices it feeds. There would be only one timeout value that could be set for that receiver.

If the timeout timer were to monitor a transmitter, then an excessively long transmission from just one source would shut down the transmitter regardless of the other sources feeding it. There would be only one timeout value that could be set for that transmitter.

But in the 7330 the timeout timers monitor paths, so an excessively long transmission shuts down only the affected path. And, each path can have its own timeout value.

Here's how a path timeout timer works.

The timer starts when a path becomes active and runs until the path becomes inactive.

If the path stays continuously active and the timer reaches the timeout value, the path is turned off, the Timeout Message is sent, and the Timeout Macro is executed. (Note that although the path is now timed out, other paths to the same transmitter may be active and the transmitter may still be on the air.)

When the offending signal disappears, the Penalty Timer starts. If the path becomes active again while the penalty timer is running, the penalty timer waits until the path is inactive and then restarts. When the activity finally disappears and the penalty timer expires, the End Timeout Message is sent and the End Timeout Macro is executed. The path is no longer timed out and is available for communications.

The timeout timer can be reset by command at any point during this cycle.

## Enable/Disable Path Timeout Timer

You can completely disable a timeout timer with the *Enable/Disable Path Timeout Timer* command. You can also disable it by setting the timeout timer value to zero.

Disabling a timeout timer is the same thing as setting it to infinity. If a timeout timer is disabled, there is no time limit on how long a transmitter can be keyed via that path.

---



---

## Enable/Disable Path Timeout Timer

Turns ON or OFF the Timeout Timer for a specific path.

- Enter the password, the two-digit root number, the four-digit software switch number, and one digit (0 to disable the timer, 1 to enable it).

---



---

### Command Form:

Command	Form	Data Digit
Enable/Disable RX1-TX1 Timeout Timer	(PW) 63 0161 x *	0 = OFF (disabled) 1 = ON (enabled)
Enable/Disable RX2-TX1 Timeout Timer	(PW) 63 0162 x *	
Enable/Disable RX3-TX1 Timeout Timer	(PW) 63 0163 x *	
Enable/Disable RX1-TX2 Timeout Timer	(PW) 63 0261 x *	
Enable/Disable RX2-TX2 Timeout Timer	(PW) 63 0262 x *	
Enable/Disable RX3-TX2 Timeout Timer	(PW) 63 0263 x *	
Enable/Disable RX1-TX3 Timeout Timer	(PW) 63 0361 x *	
Enable/Disable RX2-TX3 Timeout Timer	(PW) 63 0362 x *	
Enable/Disable RX3-TX3 Timeout Timer	(PW) 63 0363 x *	

**Acknowledgment:** Sends OK message

### Errors:

Error	Meaning
? err 1	wrong number of digits entered
? err 2	illegal digit entered

**Default:** All Path Timeout Timers are ON (enabled)

### Examples:

To disable the RX1-TX2 timeout timer, enter:

```
(PW) 63 0261 0 *
```

To enable it again, enter:

```
(PW) 63 0261 1 *
```

## Path Timeout Value

A timeout value of only one or two minutes might be appropriate on a very busy repeater to discourage ragchewing. Three minutes is a common timeout value for less busy systems. Some systems encourage ragchewing by allowing transmissions as long as five or ten minutes.

Perhaps a variable timeout system based on the hour works best for you. For example, the timeout can be short during drive time and long during evening hours. The 7330's scheduler can be programmed to change the timeout value depending on the time of day, day of week, and so on.

Each timeout timer can be set to any value from zero to 65,535 seconds. (The maximum value, 65,535 seconds, is just over 1,092 minutes and just over 18 hours).

To disable the timeout timer completely, see the *Enable/Disable Path Timeout Timer* command. You can also set the timeout timer to zero to disable it.



## Select Path Timeout Value

Controls the maximum amount of time a path can be active.

- Enter the password, the two-digit root number, the four-digit timer number, and one to five digits from 0 to 65535 to set the path timeout timer to 0 to 65535 seconds.
- Set the timeout value to zero to disable the Path Timeout Timer.

### Command Form:

Command	Form	Data Digit
Select RX1-TX1 Timeout Value	(PW) 09 2100 xxxxx *	xxxxx = 0-65535 = 0-65535 seconds
Select RX2-TX1 Timeout Value	(PW) 09 2101 xxxxx *	
Select RX3-TX1 Timeout Value	(PW) 09 2102 xxxxx *	
Select RX1-TX2 Timeout Value	(PW) 09 2200 xxxxx *	
Select RX2-TX2 Timeout Value	(PW) 09 2201 xxxxx *	
Select RX3-TX2 Timeout Value	(PW) 09 2202 xxxxx *	
Select RX1-TX3 Timeout Value	(PW) 09 2300 xxxxx *	
Select RX2-TX3 Timeout Value	(PW) 09 2301 xxxxx *	
Select RX3-TX3 Timeout Value	(PW) 09 2302 xxxxx *	

**Acknowledgment:** Sends *OK* message

### Errors:

Error	Meaning
? err 1	wrong number of digits entered
? err 2	illegal digit entered

**Default:** All Path Timeout Timers default to 180 seconds (3 minutes).

### Examples:

The timeout timers are programmed in seconds. For example, if you wish to set the RX1-TX1 timeout timer to 4.5 minutes, multiply 4.5 minutes by 60 seconds/minute to get 270 seconds. Enter:

```
(PW) 09 2100 270 *
```

To set the RX2-TX1 timeout timer to 10 minutes (600 seconds), enter:

```
(PW) 09 2101 600 *
```

## Path Penalty Time Value

The Path Penalty Timer starts when the path activity that caused the timeout finally ends. The penalty is usually set to a few seconds to prevent the timeout from being reset by a short signal loss or flutter.

The penalty timer can be a way to reinforce observation of the courtesy delay. If a user times out, he won't know it until he releases the mic button and discovers the repeater is down. He may *chirp* (press the mic button momentarily) several times, but since the path is timed out, he will only keep restarting the penalty timer at the end of each transmission. The path must be completely inactive for the duration of the penalty time for the timeout to end.

A user can also enter the *Reset Path Timeout Timer* command to end the timeout.

Each path penalty timer can be set to any value from zero to 6553.5 seconds. Setting the penalty to zero means the timeout ends as soon as the path activity ends.

## Select Path Penalty Time Value

Selects the length of time a path must remain inactive after timeout before timeout is reset.

- Enter the password, the two-digit root number, the four-digit timer number, and 1 to 5 digits from 0 to 65535 to set the penalty timer to 0 to 6553.5 seconds. The data is in one-tenth second increments.

### Command Form:

Command	Form	Data Digit
Select RX1-TX1 Penalty Time Value	(PW) 09 1100 xxxxx *	xxxxx = 0-65535 = 0-6553.5 seconds
Select RX2-TX1 Penalty Time Value	(PW) 09 1101 xxxxx *	
Select RX3-TX1 Penalty Time Value	(PW) 09 1102 xxxxx *	
Select RX1-TX2 Penalty Time Value	(PW) 09 1200 xxxxx *	
Select RX2-TX2 Penalty Time Value	(PW) 09 1201 xxxxx *	
Select RX3-TX2 Penalty Time Value	(PW) 09 1202 xxxxx *	
Select RX1-TX3 Penalty Time Value	(PW) 09 1300 xxxxx *	
Select RX2-TX3 Penalty Time Value	(PW) 09 1301 xxxxx *	
Select RX3-TX3 Penalty Time Value	(PW) 09 1302 xxxxx *	

**Acknowledgment:** Sends OK message

### Errors:

Error	Meaning
? err 1	wrong number of digits entered
? err 2	illegal digit entered

**Default:** All Path Penalty Timers default to 5.0 seconds.

### Example:

To set the RX1-TX1 path penalty timer to 2.5 seconds, enter:

```
(PW) 09 1100 25 *
```

## Reset Path Timeout Timer

This command can be entered to bring the path back up when it is timed out.

For example, if a user causes a path timeout, another user can reset the timer with this command. Of course, that involves having a better signal at the receiver than the offending station or having access to the controller via another port.

Entering the *Reset Path Timeout Timer* command reloads the timer and returns the path to the air.

---



---

## Reset Path Timeout Timer

Resets a Path Timeout.

- Enter the password, the two-digit root number, the four-digit software switch number, and %**n**+ for the data digit.

---



---

### Command Form:

Command	Form
Reset RX1-TX1 Timeout Timer	(PW) 63 0171 1 *
Reset RX2-TX1 Timeout Timer	(PW) 63 0172 1 *
Reset RX3-TX1 Timeout Timer	(PW) 63 0173 1 *
Reset RX1-TX2 Timeout Timer	(PW) 63 0271 1 *
Reset RX2-TX2 Timeout Timer	(PW) 63 0272 1 *
Reset RX3-TX2 Timeout Timer	(PW) 63 0273 1 *
Reset RX1-TX3 Timeout Timer	(PW) 63 0371 1 *
Reset RX2-TX3 Timeout Timer	(PW) 63 0372 1 *
Reset RX3-TX3 Timeout Timer	(PW) 63 0373 1 *

**Acknowledgment:** Sends OK message

### Errors:

Error	Meaning
? err 1	wrong number of digits entered
? err 2	illegal digit entered

**Default:** None

### Example:

If the RX3-TX1 path has timed out, you can enter this command to end the timeout:

```
(PW) 63 0173 1 *
```

## **Path Timeout Message**

### **Path Timeout End Message**

These commands let you program and play back two different messages: One is sent when a path times out, and the other is sent when the timeout ends.

A message may contain any combination of message types, including CW, beeps, page tones, digital audio files, and so on.

The maximum size of a message is 50 bytes (50 2-digit codes). You must count any control characters as well.

Listening stations hear the Path Timeout Message; the transmitting station doesn't. So, the Path Timeout Message informs listening stations of the timeout so they won't wonder why the transmitting station (and the repeater) are suddenly off the air.

The transmitting station and the listening stations hear the Path Timeout End Message. It's not sent until the timeout ends, and the timeout doesn't end until the transmitting station stops transmitting and the penalty time elapses. So, the Path Timeout End Message informs the last user that his transmission may not have been entirely received, and it informs everyone that the path is again available for communication.

---



---

## Select/Review Path Timeout Message

Program or review the path timeout message.

- To program a message, enter the password, the two-digit root number, the four-digit message number, and the message.
  - To delete a message, enter the password, the two-digit root number, the four-digit message number, and the (\*), omitting the message.
  - To review (play back) a message, enter the password, the two-digit root number, and the four-digit message number.
- 
- 

### Command Form:

Command	Form	Default
Select RX1-TX1 Timeout Message	(PW) 31 0103 (message) *	TO in CW, 523 Hz
Select RX2-TX1 Timeout Message	(PW) 31 0104 (message) *	TO in CW, 659 Hz
Select RX3-TX1 Timeout Message	(PW) 31 0105 (message) *	TO in CW, 784 Hz
Select RX1-TX2 Timeout Message	(PW) 31 0203 (message) *	TO in CW, 988 Hz
Select RX2-TX2 Timeout Message	(PW) 31 0204 (message) *	TO in CW, 1175 Hz
Select RX3-TX2 Timeout Message	(PW) 31 0205 (message) *	TO in CW, 1397 Hz
Select RX1-TX3 Timeout Message	(PW) 31 0303 (message) *	TO in CW, 1568 Hz
Select RX2-TX3 Timeout Message	(PW) 31 0304 (message) *	TO in CW, 1760 Hz
Select RX3-TX3 Timeout Message	(PW) 31 0305 (message) *	TO in CW, 1976 Hz
Review RX1-TX1 Timeout Message	(PW) 34 0103 *	none
Review RX2-TX1 Timeout Message	(PW) 34 0104 *	none
Review RX3-TX1 Timeout Message	(PW) 34 0105 *	none
Review RX1-TX2 Timeout Message	(PW) 34 0203 *	none
Review RX2-TX2 Timeout Message	(PW) 34 0204 *	none
Review RX3-TX2 Timeout Message	(PW) 34 0205 *	none
Review RX1-TX3 Timeout Message	(PW) 34 0303 *	none
Review RX2-TX3 Timeout Message	(PW) 34 0304 *	none
Review RX3-TX3 Timeout Message	(PW) 34 0305 *	none

**Acknowledgment:** Sends OK message

### Errors:

Error	Meaning
? err 1	wrong number of digits entered
? err 2	illegal digit entered

**Default:** See table above.

### Example:

To program %ME+in CW as the RX1-TX1 path timeout message, enter:

```
(PW) 31 0103 9900 29 18 22 14 *
```

---



---

## Select/Review Path Timeout-End Message

Program or review the path timeout-end message.

- To program a message, enter the password, the two-digit root number, the four-digit message number, and the message.
- To delete a message, enter the password, the two-digit root number, the four-digit message number, and the (\*), omitting the message.
- To review (play back) a message, enter the password, the two-digit root number, and the four-digit message number.

---



---

### Command Form:

Command	Form
Select RX1-TX1 Timeout-End Message	(PW) 31 0106 (message) *
Select RX2-TX1 Timeout-End Message	(PW) 31 0107 (message) *
Select RX3-TX1 Timeout-End Message	(PW) 31 0108 (message) *
Select RX1-TX2 Timeout-End Message	(PW) 31 0206 (message) *
Select RX2-TX2 Timeout-End Message	(PW) 31 0207 (message) *
Select RX3-TX2 Timeout-End Message	(PW) 31 0208 (message) *
Select RX1-TX3 Timeout-End Message	(PW) 31 0306 (message) *
Select RX2-TX3 Timeout-End Message	(PW) 31 0307 (message) *
Select RX3-TX3 Timeout-End Message	(PW) 31 0308 (message) *
Review RX1-TX1 Timeout-End Message	(PW) 34 0106 *
Review RX2-TX1 Timeout-End Message	(PW) 34 0107 *
Review RX3-TX1 Timeout-End Message	(PW) 34 0108 *
Review RX1-TX2 Timeout-End Message	(PW) 34 0206 *
Review RX2-TX2 Timeout-End Message	(PW) 34 0207 *
Review RX3-TX2 Timeout-End Message	(PW) 34 0208 *
Review RX1-TX3 Timeout-End Message	(PW) 34 0306 *
Review RX2-TX3 Timeout-End Message	(PW) 34 0307 *
Review RX3-TX3 Timeout-End Message	(PW) 34 0308 *

**Acknowledgment:** Sends OK message

### Errors:

Error	Meaning
? err 1	wrong number of digits entered
? err 2	illegal digit entered

**Default:** Sends TO in CW.



## Path Timeout Macro

### Path Timeout End Macro

The first command selects a macro to be executed when a path times out. The second command selects a macro to be executed when a path returns from timeout.

The Path Timeout Macro is executed at the same time the timeout message is sent, and the Path Timeout End Macro is executed at the same time the timeout end message is sent. They are both examples of event-triggered macros; they are executed automatically, based on certain events.

Since we already have messages, why also execute macros?

Any command (or group of commands) can be stored in a macro, which allows you to perform other actions besides sending messages. You can use a logic output to activate something at the site, or execute a command that changes the path access, something like that.

---



---

## Select Path Timeout Macro

Assigns a macro to be triggered when a path timeout occurs.

- Enter the password, the two-digit root number, the four-digit event number, and a four-digit macro name. Use leading zeros if the macro name has fewer than four digits.
  - To unassign a macro, enter the command but omit the macro name.
- 
- 

### Command Form:

Command	Form
Select RX1-TX1 Timeout Macro	(PW) 26 0130 (macro name) *
Select RX2-TX1 Timeout Macro	(PW) 26 0131 (macro name) *
Select RX3-TX1 Timeout Macro	(PW) 26 0132 (macro name) *
Select RX1-TX2 Timeout Macro	(PW) 26 0230 (macro name) *
Select RX2-TX2 Timeout Macro	(PW) 26 0231 (macro name) *
Select RX3-TX2 Timeout Macro	(PW) 26 0232 (macro name) *
Select RX1-TX3 Timeout Macro	(PW) 26 0330 (macro name) *
Select RX2-TX3 Timeout Macro	(PW) 26 0331 (macro name) *
Select RX3-TX3 Timeout Macro	(PW) 26 0332 (macro name) *

**Acknowledgment:** Sends *OK* message

### Errors:

Error	Meaning
? err 1	wrong number of digits entered
? err 2	illegal digit entered

**Default:** None assigned.

### Example:

To have macro 123 executed when the RX1-TX1 path times out, enter:

```
(PW) 26 0130 0123 *
```

---



---

## Select Path Timeout-End Macro

Assigns a macro to be triggered when a path returns from timeout.

- Enter the password, the two-digit root number, the four-digit event number, and a four-digit macro name. Use leading zeros if the macro name has fewer than four digits.
- To unassign a macro, enter the command but omit the macro name.

---



---

### Command Form:

Command	Form
Select RX1-TX1 Timeout-End Macro	(PW) 26 0138 (macro name) *
Select RX2-TX1 Timeout-End Macro	(PW) 26 0139 (macro name) *
Select RX3-TX1 Timeout-End Macro	(PW) 26 0140 (macro name) *
Select RX1-TX2 Timeout-End Macro	(PW) 26 0238 (macro name) *
Select RX2-TX2 Timeout-End Macro	(PW) 26 0239 (macro name) *
Select RX3-TX2 Timeout-End Macro	(PW) 26 0240 (macro name) *
Select RX1-TX3 Timeout-End Macro	(PW) 26 0338 (macro name) *
Select RX2-TX3 Timeout-End Macro	(PW) 26 0339 (macro name) *
Select RX3-TX3 Timeout-End Macro	(PW) 26 0340 (macro name) *

**Acknowledgment:** Sends OK message

### Errors:

Error	Meaning
? err 1	wrong number of digits entered
? err 2	illegal digit entered

**Default:** None assigned.

## Path Courtesy Message

These commands program and play back the Path Courtesy Message for each path.

The 7330 sends the Path Courtesy Message shortly after all paths to a transmitter become inactive. (The amount of delay is controlled by the Courtesy Timer. See the Transmitter chapter.)

The courtesy message may contain any combination of message types, including CW, beeps, page tones, digital audio files, and so on. Or, it can be silenced by programming no message at all.

The maximum size of a message is 50 bytes (50 2-digit codes). You must count any control characters as well.

Each path can have its own distinct courtesy message. While the message can be a single beep carrying no more information than the timeout timer is now reset, it can be used to identify the path if more than one path feeds a transmitter. For example, the local repeater input might send a CW `%R+` and the link might send a CW `%L+`. Or the letter might indicate from which linked city the transmission originated.

Another idea is to use the courtesy message to indicate current conditions. You can create macros that store various courtesy messages, then (with logic inputs) have them executed automatically when the main site power fails, a switch changes state, and so on. A macro can be entered by a club official to change the courtesy message during severe weather.

Courtesy Messages should not be long or distracting as they will be heard many times a day. Some users prefer to put more information into the Dropout Message, which is heard less often, or perhaps into the identification message.

## Select/Review Path Courtesy Message

Program or review the Path Courtesy Message that is sent when the Path Courtesy Timer expires.

- To program a message, enter the password, the two-digit root number, the four-digit message number, and the message.
- To delete a message, enter the command but omit the message.
- To review a message, enter the password, the two-digit root number, and the four-digit message number.

### Command Form:

Command	Form	Default
Select RX1-TX1 Courtesy Message	(PW) 31 0100 (message) *	523 Hz, 60 ms
Select RX2-TX1 Courtesy Message	(PW) 31 0101 (message) *	659 Hz, 60 ms
Select RX3-TX1 Courtesy Message	(PW) 31 0102 (message) *	784 Hz, 60 ms
Select RX1-TX2 Courtesy Message	(PW) 31 0200 (message) *	988 Hz, 60 ms
Select RX2-TX2 Courtesy Message	(PW) 31 0201 (message) *	1175 Hz, 60 ms
Select RX3-TX2 Courtesy Message	(PW) 31 0202 (message) *	1397 Hz, 60 ms
Select RX1-TX3 Courtesy Message	(PW) 31 0300 (message) *	1568 Hz, 60 ms
Select RX2-TX3 Courtesy Message	(PW) 31 0301 (message) *	1760 Hz, 60 ms
Select RX3-TX3 Courtesy Message	(PW) 31 0302 (message) *	1976 Hz, 60 ms
Review RX1-TX1 Courtesy Message	(PW) 34 0100 *	
Review RX2-TX1 Courtesy Message	(PW) 34 0101 *	
Review RX3-TX1 Courtesy Message	(PW) 34 0102 *	
Review RX1-TX2 Courtesy Message	(PW) 34 0200 *	
Review RX2-TX2 Courtesy Message	(PW) 34 0201 *	
Review RX3-TX2 Courtesy Message	(PW) 34 0202 *	
Review RX1-TX3 Courtesy Message	(PW) 34 0300 *	
Review RX2-TX3 Courtesy Message	(PW) 34 0301 *	
Review RX3-TX3 Courtesy Message	(PW) 34 0302 *	

**Acknowledgment:** Sends OK message

### Errors:

Error	Meaning
? err 1	wrong number of digits entered
? err 2	illegal digit entered

**Default:** See default column of table.

### Example:

To change the RX1-TX1 courtesy message to two single-tone beeps, enter:

```
(PW) 31 0100 9910 28 16 *
```

To turn off the the RX3-TX1 courtesy message, enter:

```
(PW) 31 0102 *
```

## Path Courtesy Macro

This command selects a macro to be executed when a path becomes inactive.

The Path Courtesy Macro is another example of an event-triggered macro and is executed at the same time the courtesy message is sent.

Since we already have the message, why also execute a macro?

Any command (or group of commands) can be stored in a macro, which allows you to perform other actions besides sending messages. You can use a logic output to activate something at the site, or execute a command that changes the path access, or something similar.

You can also use a Courtesy Macro to select a message to play. For example, you could change the message based on which voter channel is selected. In the following example, the CTCSS Logic Input for RX2 is checked:

```
; Voter Channel 1 Macro 0123
(PW) 20 0123 (PW) 15 9910 24 *

; Voter Channel 2 Macro 0124
(PW) 20 0124 (PW) 15 9910 30 *

; If RX2 CTCSS Logic Input ON/OFF
(PW) 20 0125 (PW) 76 04 0204 0124 0123 *

; Select RX2-TX1 Courtesy Macro 0125
(PW) 26 0123 0125 *
```

---



---

## Select Path Courtesy Macro

Assigns a macro to be triggered when the Path Courtesy Timer expires.

- Enter the password, the two-digit root number, the four-digit event number, and a four-digit macro name. Use leading zeros if the macro name has fewer than four digits.
  - To unassign a previously assigned macro, enter the command but omit the macro name.
- 
- 

### Command Form:

Command	Form
Select RX1-TX1 Courtesy Macro	(PW) 26 0122 (macro name) *
Select RX2-TX1 Courtesy Macro	(PW) 26 0123 (macro name) *
Select RX3-TX1 Courtesy Macro	(PW) 26 0124 (macro name) *
Select RX1-TX2 Courtesy Macro	(PW) 26 0222 (macro name) *
Select RX2-TX2 Courtesy Macro	(PW) 26 0223 (macro name) *
Select RX3-TX2 Courtesy Macro	(PW) 26 0224 (macro name) *
Select RX1-TX3 Courtesy Macro	(PW) 26 0322 (macro name) *
Select RX2-TX3 Courtesy Macro	(PW) 26 0323 (macro name) *
Select RX3-TX3 Courtesy Macro	(PW) 26 0324 (macro name) *

**Acknowledgment:** Sends *OK* message

### Errors:

Error	Meaning
? err 1	wrong number of digits entered
? err 2	illegal digit entered

**Default:** None assigned.

### Example:

To assign macro 789 to be executed at the end of the RX2-TX1 courtesy delay, enter:

```
(PW) 26 0123 0789 *
```

## Introduction to Start of Activity and End of Activity Macros

When a path first becomes active, the controller executes the Start of Activity Macro and then monitors the activity. When the path goes inactive, a programmable timer is started. If activity resumes before the timer expires, the inactive period is ignored. If the path stays inactive and the timer expires, the activity cycle is considered ended. The controller checks a counter. If the counter reads zero, the End of Activity Macro is executed, the counter is reloaded, and the controller waits for a new activity cycle to begin. If the counter reads some other number, the count is decremented and the controller waits for a new activity cycle to begin.

The two macros, then, can be seen as bookends that mark the beginning and end of a period of activity. You can use just the Start macro, the End macro, both, or neither. The Start macro is triggered at the beginning of each and every cycle, and the End macro is triggered depending on the count. You can program the counter from zero to 65,535 activity cycles and you can program the timer from zero to 65,535 seconds. Note that the count tells the controller how many events to skip; so, setting the counter to zero means the End macro executes every activity cycle. Setting the counter to 1 means the macro executes every other activity cycle, and setting it to 99 means the macro executes every 100 cycles.

What's the value of this feature? It allows you to do things -- like send reminder messages or activate certain hardware -- when you know users are monitoring, rather than at a certain time, date, or other condition. The timer lets you choose how long after a conversation ends to send the message, etc., and the counter lets you choose how often this will happen.

For example, let's say you wish to tape record all repeater conversations. You'd use the Start macro to begin recording and the End macro to end recording. You'd set the counter to zero so that the recorder operates on every activity cycle, and you'd set the timer so that the recorder continues to run a few seconds after activity to prevent it from turning on and off too often.

As another example, let's say you have a message regarding an upcoming event and you'd like it played on the repeater occasionally but not often enough to be annoying. You'd ignore the Start macro and use the End macro to send the message. You might set the counter to 4, which sends the message every 5<sup>th</sup> time the repeater is used, and set the timer to 1 minute. Most users will probably still have their radios on one minute after the conversation.

Note that the end of activity is based on the path, that is, the moment the user unkeys. It is not based on some part of the transmitter tail.



## Select Path Start-of-Activity and Path End-of-Activity Macros

Allows the programmer to execute macros based on the long-term activity of the path.

- Enter the password, the two-digit root number, the four-digit event number, and a four-digit macro name. Use leading zeros if the macro name has fewer than four digits.
- To unassign a previously assigned macro, enter the command but omit the macro name.

### Command Form:

Command	Form
Select RX1-TX1 Start-of-Activity Macro	(PW) 26 0146 (macro name) *
Select RX1-TX1 End-of-Activity Macro	(PW) 26 0154 (macro name) *
Select RX2-TX1 Start-of-Activity Macro	(PW) 26 0147 (macro name) *
Select RX2-TX1 End-of-Activity Macro	(PW) 26 0155 (macro name) *
Select RX3-TX1 Start-of-Activity Macro	(PW) 26 0148 (macro name) *
Select RX3-TX1 End-of-Activity Macro	(PW) 26 0156 (macro name) *
Select RX1-TX2 Start-of-Activity Macro	(PW) 26 0246 (macro name) *
Select RX1-TX2 End-of-Activity Macro	(PW) 26 0254 (macro name) *
Select RX2-TX2 Start-of-Activity Macro	(PW) 26 0247 (macro name) *
Select RX2-TX2 End-of-Activity Macro	(PW) 26 0255 (macro name) *
Select RX3-TX2 Start-of-Activity Macro	(PW) 26 0248 (macro name) *
Select RX3-TX2 End-of-Activity Macro	(PW) 26 0256 (macro name) *
Select RX1-TX3 Start-of-Activity Macro	(PW) 26 0346 (macro name) *
Select RX1-TX3 End-of-Activity Macro	(PW) 26 0354 (macro name) *
Select RX2-TX3 Start-of-Activity Macro	(PW) 26 0347 (macro name) *
Select RX2-TX3 End-of-Activity Macro	(PW) 26 0355 (macro name) *
Select RX3-TX3 Start-of-Activity Macro	(PW) 26 0348 (macro name) *
Select RX3-TX3 End-of-Activity Macro	(PW) 26 0356 (macro name) *

**Acknowledgment:** Sends OK message

### Errors:

Error	Meaning
? err 1	wrong number of digits entered
? err 2	illegal digit entered

**Default:** No Macros are assigned

### Example:

To assign macro 73 to RX1-TX1 end-of-activity, enter:

(PW) 26 0154 0073 \*

---



---

## Select Path End-of-Activity Counter and Timer

Programs the End-of-Activity Counter and Timer for a path.

- Set the count to zero to have the macro executed after every time the timer expires.
- Set the timer for the number of seconds that the path is idle before the counter value is evaluated.
- To select the count, enter the password, the two-digit root number, the four-digit counter number, and a one-to-five digit count.
- To select the timer, enter the password, the two-digit root number, the four-digit timer number, and a one-to-five digit delay in seconds.

---



---

### Command Form:

Command	Form	Data Digit
Select RX1-TX1 End-of-Activity Counter	(PW) 45 0101 xxxxx *	xxxxx = event count = 0. 65535
Select RX1-TX1 End-of-Activity Timer	(PW) 09 2103 xxxxx*	xxxxx = 0-65535 = 0-65535 seconds
Select RX2-TX1 End-of-Activity Counter	(PW) 45 0102 xxxxx *	xxxxx = event count = 0. 65535
Select RX2-TX1 End-of-Activity Timer	(PW) 09 2104 xxxxx*	xxxxx = 0-65535 = 0-65535 seconds
Select RX3-TX1 End-of-Activity Counter	(PW) 45 0103 xxxxx *	xxxxx = event count = 0. 65535
Select RX3-TX1 End-of-Activity Timer	(PW) 09 2105 xxxxx*	xxxxx = 0-65535 = 0-65535 seconds
Select RX1-TX2 End-of-Activity Counter	(PW) 45 0201 xxxxx *	xxxxx = event count = 0. 65535
Select RX1-TX2 End-of-Activity Timer	(PW) 09 2203 xxxxx*	xxxxx = 0-65535 = 0-65535 seconds
Select RX2-TX2 End-of-Activity Counter	(PW) 45 0202 xxxxx *	xxxxx = event count = 0. 65535
Select RX2-TX2 End-of-Activity Timer	(PW) 09 2204 xxxxx*	xxxxx = 0-65535 = 0-65535 seconds

**Command Form:**

Select RX3-TX2 End-of-Activity Counter	(PW) 45 0203 xxxxx *	xxxxx = (event count) = (0. 65535)
Select RX3-TX2 End-of-Activity Timer	(PW) 09 2205 xxxxx*	xxxxx = (0-65535) = (0-65535) seconds
Select RX1-TX3 End-of-Activity Counter	(PW) 45 0301 xxxxx *	xxxxx = (event count) = (0. 65535)
Select RX1-TX3 End-of-Activity Timer	(PW) 09 2303 xxxxx*	xxxxx = (0-65535) = (0-65535) seconds
Select RX2-TX3 End-of-Activity Counter	(PW) 45 0302 xxxxx *	xxxxx = (event count) = (0. 65535)
Select RX2-TX3 End-of-Activity Timer	(PW) 09 2304 xxxxx*	xxxxx = (0-65535) = (0-65535) seconds
Select RX3-TX3 End-of-Activity Counter	(PW) 45 0303 xxxxx *	xxxxx = (event count) = (0. 65535)
Select RX3-TX3 End-of-Activity Timer	(PW) 09 2305 xxxxx*	xxxxx = (0-65535) = (0-65535) seconds

**Acknowledgment:** Sends OK message

**Errors:**

Error	Meaning
? err 1	wrong number of digits entered
? err 2	illegal digit entered

**Default:** Counter is 0; Timer is 60 seconds (1 minute)

**Example:**

A repeater is connected to RX1-TX1. We want the end-of-activity macro (which contains a message we want listeners to hear) triggered after every 5<sup>th</sup> conversation. It should be sent 45 seconds after the conversation ends. Enter:

```
(PW) 45 0101 4 *      ; skip count = 4
(PW) 09 2103 45 *     ; time delay = 45 seconds
```

**Example: Temporarily Change The Access Mode**

In this example, we change the repeater access mode by DTMF command then use an Activity Timer/Counter/Macro to return the repeater access to its original setting after the repeater is idle for a time. The repeater is on port 1 and normally set to use both COR and CTCSS logic inputs. Users will enter 107\* to change the access to Carrier. The user will enter 102\* to return the access to Carrier AND CTCSS or the controller will do it after the repeater has been idle for 5 minutes. Each macro also speaks a message to inform users that the access mode has changed.

For users to be able to enter a DTMF command without CTCSS, the access mode for DTMF is separately configured for Carrier access.

```
(PW) 57 1 1 * ; set path 1 to COR
```

Macro 107 changes the access mode for each path from RX1 to Carrier access. In the example below, only change the paths that are used in your controller.

```
(PW) 20 0107 DD 57 11 1 * ; set path 11 to COR
(PW) 29 0107 DD 57 12 1 * ; set path 12 to COR
(PW) 29 0107 DD 57 13 1 * ; set path 13 to COR
(PW) 29 0107 DD 15 9960 0339 0001 0283 0562 * ; speak
```

Macro 102 changes the access mode for each path from RX1 to Carrier AND CTCSS access. In the example below, only change the paths that are used in your controller.

```
(PW) 20 0102 DD 57 11 3 * ; set path 11 to COR AND CTCSS
(PW) 29 0102 DD 57 12 3 * ; set path 12 to COR AND CTCSS
(PW) 29 0102 DD 57 13 3 * ; set path 13 to COR AND CTCSS
(PW) 29 0102 DD 9960 0339 0001 0283 0060 0056 * ; speak
```

Configure the Activity Timer/Counter/Macro with the following commands.

```
(PW) 45 0101 0 * ; set counter to every time
(PW) 09 2103 300 * ; set timer to 5 minutes
(PW) 26 0154 0102 * ; set End Activity macro
```

107 and 102 are macro names selected for this example. You can change them to any valid macro name that you want.

You can also use other signalling techniques to change the access modes. For example, you might configure a Long Tone (LiTZ, see page 7-29) that executes the macro that changes the access. Or, you can configure a COR Pulse-Triggered Macro (see page 10-21) to execute the macro that changes the access. Or, you can implement any combination of them.

---

## Chapter 10

# Receiver Commands

---

Receiver-related commands appear in this chapter and in two others: Chapter 9 (receiver-to-transmitter paths) and Chapter 7 (receiver-to-DTMF decoder paths).

In this chapter we will describe:

1. The **COR Filter**, the **CTCSS Filter**, and the **Anti-Kerchunker**. These features reduce nuisance key-ups.
2. The **Flutter Filter**. This feature reduces courtesy beeps and audio dropouts when mobile stations picket-fence+(flutter).
3. The **Audio Delay** and **Audio Gate Delay**. This feature makes use of hardware and software to eliminate squelch tail noise bursts and improve DTMF muting.
4. The **COR Simulate** and **CTCSS Simulate** utility commands. These features help you test and troubleshoot problems with the COR and CTCSS inputs.
5. **Event-triggered macros** related to receivers, such as macros that execute on COR and CTCSS signals and on multiple key-ups.
6. The **Receiver Enable/Disable** commands. These commands provide receiver control without change the path programming.

## Front Panel COR and CTCSS LEDs

The front panel display includes an LED for each COR and CTCSS input.

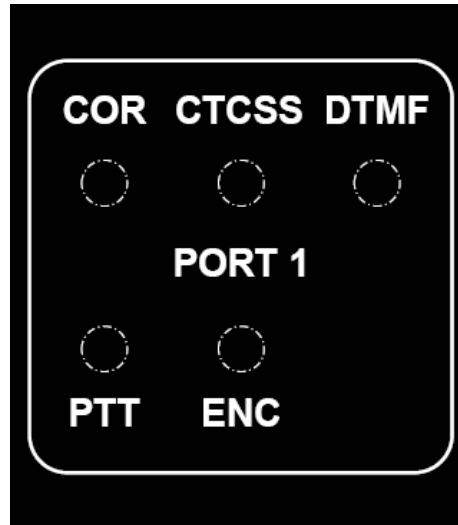

These LEDs glow when the hardware detects activity on these inputs, when the input is forced active by the *Simulate COR Active* or *Simulate CTCSS Active* commands (see page 10-16), or when the receiver is disabled.

LED State	Meaning
OFF	COR or CTCSS not active
ON	COR or CTCSS active
Alternate ON and OFF	Receiver Disabled

The LEDs show activity as it occurs at the inputs when enabled. The actual hardware input state may be either high or low, depending on whether or not the COR or CTCSS inversion jumper is in place. (See Appendix B, Installation, Receiver COR on page B-4 or Receiver CTCSS on page B-5.) The LEDs are not affected by delays from the COR Filter, CTCSS Filter, Flutter Filter, or Anti-Kerchunker.

The LEDs alternately glow when the inputs have been disabled by the *Receiver Enable/Disable* command (see page 10-27).

## COR Filter

The *COR Filter* uses a programmable timer to check incoming COR signals for minimum duration. If the COR signal disappears before the timer expires, the signal is ignored. If the COR signal is still present when the timer expires, it is considered valid and the controller will respond accordingly. This action delays the leading edge of the COR signal, which delays the key-up of the repeater, but it reduces nuisance repeater key-ups due to noise pulses.

There is a separate COR Filter for each receiver. If the filter is enabled for a receiver, then every COR signal coming from that receiver is filtered.

Setting the timer to zero disables the filter.

The filter is disabled on a Cold Start.

---

**Note:** The COR Filter also plays a role in the Anti-CTCSS access mode. The CTCSS decoder is usually slower than the COR/squelch circuit. By setting the COR Filter time delay at least as long as your CTCSS decoder's turn-on delay, you will make sure the controller won't respond to a COR signal until after the CTCSS decoder determines that there is no unwanted CTCSS tone accompanying it.

---

---



---

## Select COR Filter Delay

Delays the controller's response to the leading edge of COR.

- Enter the password, the two-digit root number, the four-digit timer number, and one to five digits from 0 to 65535 to set the delay to 0.00 to 655.35 seconds.
  - To disable the filter, set its delay to 0.
- 
- 

### Command Form:

Command	Form	Data Digit
Select RX1 COR Filter Delay	(PW) 09 0112 xxxxx *	xxxxx = 0-65535 = 0-655.35 seconds
Select RX2 COR Filter Delay	(PW) 09 0212 xxxxx *	
Select RX3 COR Filter Delay	(PW) 09 0312 xxxxx *	

**Acknowledgment:** Sends *OK* message

### Errors:

Error	Meaning
? err 1	wrong number of digits entered
? err 2	illegal digit entered

**Default:** COR Filter Delay is disabled (0.00 seconds).

### Example:

To select an 80-millisecond (0.08 second) COR Filter Delay for RX2, enter:

```
(PW) 09 0212 8 *
```



## CTCSS Filter

The *CTCSS Filter* uses a programmable timer to check incoming CTCSS signals for minimum duration. If the output of the CTCSS decoder goes inactive before the timer expires, the decoder is ignored. If the output of the CTCSS decoder is still present when the timer expires, it is considered valid and the controller will respond accordingly. This action delays the leading edge of the CTCSS signal, which delays the key-up of the repeater, but it reduces nuisance repeater key-ups due to decoder falsing from adjacent channel activity.

There is a separate CTCSS Filter for each receiver. If the filter is enabled for a receiver, then every CTCSS signal from that receiver is filtered.

Setting the timer to zero disables the filter.

The filter is disabled on a Cold Start.

---



---

## Select CTCSS Filter Delay

Delays the controller's response to the leading edge of CTCSS.

- Enter the password, the two-digit root number, the four-digit timer number, and one to five digits from 0 to 65535 to set the delay to 0.00 to 655.35 seconds.
- To disable the filter, set its delay to 0.

---



---

### Command Form:

Command	Form	Data Digit
Select RX1 CTCSS Filter Delay	(PW) 09 0113 xxxxx *	xxxxx = 0-65535 = 0-655.35 seconds
Select RX2 CTCSS Filter Delay	(PW) 09 0213 xxxxx *	
Select RX3 CTCSS Filter Delay	(PW) 09 0313 xxxxx *	

**Acknowledgment:** Sends *OK* message

### Errors:

Error	Meaning
? err 1	wrong number of digits entered
? err 2	illegal digit entered

**Default:** CTCSS Filter Delay is disabled (0.00 seconds).

### Example:

To select a 150-millisecond (0.15 second) CTCSS Filter Delay for RX2, enter:

```
(PW) 09 0213 15 *
```

## Anti-Kerchunker

The *Anti-Kerchunker* is a type of COR filter that helps remove annoying kerchunks when there's no conversation taking place. It does this by requiring a longer initial transmission to start the conversation, after which the repeater operates normally. (Kerchunks are brief repeater key-ups caused by noise pulses and operators who feel they must test their rigs . and the repeaters . occasionally to make sure they're functional.)

There's a separate anti-kerchunker for each receiver, and each can be enabled and disabled. Here's how the anti-kerchunker works.

There are two programmable timers, one for the *Anti-Kerchunker Key-up Delay* and one for the *Anti-Kerchunker Re-Arm Delay*.

The *Anti-Kerchunker Key-Up Delay* sets the minimum time a user must transmit before the COR signal is valid. A transmission shorter than the key-up delay is ignored. When a transmission exceeds the key-up delay, the COR signal is considered valid and the controller responds accordingly. In addition, the key-up delay is forced to zero, disabling it.

When the user unkeys, the *Anti-Kerchunker Re-Arm Delay* starts. If there's no further COR activity, the re-arm timer eventually expires. That causes the key-up delay to go back to its original value. A new cycle will be started by the next user who transmits longer than the key-up delay.

Users must begin their transmissions during the re-arm delay if they want to avoid the key-up delay. The re-arm delay should be set to expire some time after the transmitter tail and identification message are finished. That way, a normal conversation proceeds with no additional key-up delays, yet the anti-kerchunker will protect the input after the conversation ends.

(Some anti-kerchunker designs start the re-arm timer when the transmitter PTT drops. The 7330's anti-kerchunker doesn't because the receiver may be driving multiple transmitters with various tail durations. Instead, the re-arm delay starts when the receiver COR drops. The owner can program the re-arm timer over a wide range of values to include the time needed by the tail and a possible ID message.)

The Anti-Kerchunker behaves very differently on initial key-up when it's in the *No Hangtime* mode. In that mode, incoming signals cause the pathed transmitter(s) to key immediately. However, if the incoming signal ends before the key-up delay expires, the transmitters unkey immediately. The offending user doesn't hear a tail or identifier and thus his kerchunk doesn't accomplish anything.

---



---

## Enable/Disable the Anti-Kerchunker

Turns ON or OFF the Anti-Kerchunker for each receiver.

- Enter the password, the two-digit root number, the four-digit software switch number, and one digit (0 to disable the Anti-Kerchunker, 1 to enable it).
- 
- 

### Command Form:

Command	Form	Data Digit
Enable/Disable RX1 Anti-Kerchunker	(PW) 63 0110 x *	0 = OFF (disabled) 1 = ON (enabled)
Enable/Disable RX2 Anti-Kerchunker	(PW) 63 0210 x *	
Enable/Disable RX3 Anti-Kerchunker	(PW) 63 0310 x *	

**Acknowledgment:** Sends OK message

### Errors:

Error	Meaning
? err 1	wrong number of digits entered
? err 2	illegal digit entered

**Default:** OFF (disabled)

### Example:

To enable the RX1 Anti-Kerchunker, enter:

```
(PW) 63 0110 1 *
```

To disable the RX1 Anti-Kerchunker, enter:

```
(PW) 63 0110 0 *
```

---



---

## Select Anti-Kerchunker Key-Up Delay

Programs the Anti-Kerchunker Key-up Delay for each receiver.

- Enter the password, the two-digit root number, the four-digit timer number, and one to five digits from 0 to 65535 to set the delay to 0.00 to 655.35 seconds.

---



---

### Command Form:

Command	Form	Data Digit
Select RX1 Anti-Kerchunker Key-Up Delay	(PW) 09 0109 xxxxx *	xxxxx = 0-65535 = 0-655.35 seconds
Select RX2 Anti-Kerchunker Key-Up Delay	(PW) 09 0209 xxxxx *	
Select RX3 Anti-Kerchunker Key-Up Delay	(PW) 09 0309 xxxxx *	

**Acknowledgment:** Sends *OK* message

### Errors:

Error	Meaning
? err 1	wrong number of digits entered
? err 2	illegal digit entered

**Default:** All Anti-Kerchunker Key-Up Delays are 1.00 seconds.

### Example:

To select a 500-millisecond (0.5 second) Key-up Delay for RX1, enter:

```
(PW) 09 0109 50 *
```

---



---

## Select Anti-Kerchunker Re-Arm Delay

Programs the Anti-Kerchunker Re-Arm Delay for each receiver.

- Enter the password, the two-digit root number, the four-digit timer number, and one to five digits from 0 to 65535 to set the delay to 0 to 65535 seconds.

---



---

### Command Form:

Command	Form	Data Digit
Select RX1 Anti-Kerchunker Re-Arm Delay	(PW) 09 2109 xxxxx *	xxxxx = 0-65535 = 0-65535 seconds
Select RX2 Anti-Kerchunker Re-Arm Delay	(PW) 09 2209 xxxxx *	
Select RX3 Anti-Kerchunker Re-Arm Delay	(PW) 09 2309 xxxxx *	

**Acknowledgment:** Sends *OK* message

### Errors:

Error	Meaning
? err 1	wrong number of digits entered
? err 2	illegal digit entered

**Default:** Anti-Kerchunker Re-Arm Delay is 60 seconds.

### Examples:

To select a 20-second Re-arm Delay for RX1, enter:

```
(PW) 09 2109 20 *
```

---



---

## Enable/Disable Anti-Kerchunker No-Hangtime Mode

Modifies the operation of the Anti-Kerchunker.

- Enter the password, the two-digit root number, the four-digit software switch number, and one digit (0 to disable No-Hangtime Mode, 1 to enable it).

---



---

### Command Form:

Command	Form	Data Digit
Enable/Disable RX1 Anti-Kerchunker No-Hangtime Mode	(PW) 63 0111 x *	0 = OFF (disabled) 1 = ON (enabled)
Enable/Disable RX2 Anti-Kerchunker No-Hangtime Mode	(PW) 63 0211 x *	
Enable/Disable RX3 Anti-Kerchunker No-Hangtime Mode	(PW) 63 0311 x *	

**Acknowledgment:** Sends *OK* message

### Errors:

Error	Meaning
? err 1	wrong number of digits entered
? err 2	illegal digit entered

**Default:** OFF (disabled)

### Example:

To make the RX3 Anti-Kerchunker work in No-Hangtime Mode, enter:

```
(PW) 63 0311 1 *
```

To make the RX3 Anti-Kerchunker work in traditional mode, enter:

```
(PW) 63 0311 0 *
```

## Flutter Filter

The *Flutter Filter* reduces the effects of mobile station flutter (picket fencing), a rapid in-and-out fading of the signal into the receiver. It can be caused by the motion of the mobile station past buildings and operation in marginal coverage areas.

The Flutter Filter exists in the path software and examines the signal for dropouts after path access. That means the filter doesn't look at the COR or CTCSS inputs directly, but rather at the combination as programmed by the path access mode command.

The Flutter Filter uses a programmable timer to delay the trailing edge of the transmission. The audio path is held open to reduce audio dropouts, and the tail is delayed to minimize extra Courtesy Beeps that could occur at each flutter. If the signal disappears but reoccurs before the timer expires, it is treated as continuous. If the signal doesn't reoccur before the timer expires, the trailing edge is accepted.

There's a separate Flutter Filter delay value for each port. If the filter is enabled for a port, then every transmission's trailing edge from that port is delayed. This filter is usually used on receivers, but not on wired links or IRLP nodes except in special applications.

Setting the timer to zero disables the filter.

The filter is disabled on a Cold Start.



---



---

## Select Flutter Filter Delay

The Flutter Filter reduces the effects of mobile flutter.

- Enter the password, the two-digit root number, the four-digit timer number, and one to three digits from 0 to 100 to set the delay to 0.00 to 1.00 seconds.
- To disable the filter, set its delay to 0.

---



---

### Command Form:

Command	Form	Data Digit
Select RX1 Flutter Filter Delay	(PW) 09 0118 xxx *	xxx = 0-100 = 0-1.00 seconds
Select RX2 Flutter Filter Delay	(PW) 09 0218 xxx *	
Select RX3 Flutter Filter Delay	(PW) 09 0318 xxx *	

**Acknowledgment:** Sends *OK* message

### Errors:

Error	Meaning
? err 1	wrong number of digits entered
? err 2	illegal digit entered

**Default:** Flutter Filter Delay is disabled (0.00 seconds).

### Example:

To select a 40-millisecond (0.04 second) Flutter Filter delay for RX2, enter:

```
(PW) 09 0218 4 *
```

## Audio Delay and Audio Gate Delay

There is an audio delay circuit built into the 7330 for each receiver. The audio delay continuously stores and plays back audio from the receiver to the transmitter, delaying the audio tens or hundreds of milliseconds in the process.

There are two reasons for having audio delay in a controller:

1. The delay gives the controller time to mute the audio if DTMF should be detected. That way, no trace of DTMF is heard on the output.
2. There is always a nominal delay in the action of the squelch and/or CTCSS decoder such that noise is normally heard until the gate is turned off. This squelch crash or squelch burst is eliminated with an audio delay since the noise has not yet been fed to the transmitter when the controller closes the audio gate.

There is a slight complication when the audio input to the controller is connected to a discriminator, which is ahead of the squelch circuit in a receiver: The audio delay line fills with noise when a signal is not capturing the receiver. When user activity is detected, the noise stored in the delay circuit is heard as a noise burst just before the user's audio is heard.

To eliminate this leading noise burst, the controller delays turning on the audio gate with a programmable timer. This delay is called the *Audio Gate Delay* and is driven by the leading edge of path access, which means that the audio is controlled by the combination of COR and CTCSS selected with the path access command. The duration of the delay is set with the Select Audio Gate Delay command.

---



---

## Select Audio Gate Delay

The Audio Gate Delay removes the noise burst at the beginning of a transmission when unsquelched audio is used.

- Enter the password, the two-digit root number, the four-digit timer number, and one to three digits from 0 to 100 to set the delay to 0.00 to 1.00 seconds.
- To disable, set the delay to 0.

---



---

### Command Form:

Command	Form	Data Digit
Select RX1 Audio Gate Delay	(PW) 09 0117 xxx *	xxx = 0-100 = 0-1.00 seconds
Select RX2 Audio Gate Delay	(PW) 09 0217 xxx *	
Select RX3 Audio Gate Delay	(PW) 09 0317 xxx *	

**Acknowledgment:** Sends OK message

### Errors:

Error	Meaning
? err 1	wrong number of digits entered
? err 2	illegal digit entered

**Default:** Audio Gate Delay is disabled (0.00 seconds).

### Example:

To select a 120-millisecond (0.12 second) Audio Gate Delay for RX3, enter:

```
(PW) 09 0317 12 *
```

## COR/CTCSS Simulate Software Switches

The *COR Simulate* and *CTCSS Simulate* software switches are tools that can help troubleshoot problems in your system.

These commands force COR or CTCSS inputs to appear active to the controller and allow you to study the system's operation without having to manipulate hardware at the site.

Note that these commands don't do anything beyond simulating activity at the inputs. They don't override the anti-kerchunkers, path modes, higher-priority receivers that may be active, and so on. Therefore, the results are exactly the same as if local signals were being received. (If you need to override these kinds of conditions, see the *%Always On+Path Mode*.)

You can use the COR/CTCSS Simulate commands for other things besides troubleshooting. For example, you can connect an audio device that lacks a COR output (such as a weather receiver or Space Shuttle audio feed) to one of the controller's receiver audio inputs and use the *COR Simulate* command to allow the audio to feed one or more transmitters.

---



---

## Simulate COR/CTCSS Active

Forces a COR or CTCSS input to appear active.

- Turning the switch ON makes the input appear active, exactly simulating the assertion of the COR or CTCSS input.
- Enter the password, the two-digit root number, the four-digit software switch number, and one digit (0 to remove the simulation, 1 to enable it).

---



---

### Command Form:

Command	Form	Data Digit
Enable/Disable RX1 COR Simulate	(PW) 63 0108 x *	0 = OFF (disabled) 1 = ON (enabled)
Enable/Disable RX2 COR Simulate	(PW) 63 0208 x *	
Enable/Disable RX3 COR Simulate	(PW) 63 0308 x *	
Enable/Disable RX1 CTCSS Simulate	(PW) 63 0109 x *	
Enable/Disable RX2 CTCSS Simulate	(PW) 63 0209 x *	
Enable/Disable RX3 CTCSS Simulate	(PW) 63 0309 x *	

**Acknowledgment:** Sends *OK* message

### Errors:

Error	Meaning
? err 1	wrong number of digits entered
? err 2	illegal digit entered

**Default:** OFF (disabled).

### Examples:

To simulate an active COR input for RX3, enter:

```
(PW) 63 0308 1 *
```

To turn off RX3 COR simulate, enter:

```
(PW) 63 0308 0 *
```

## COR/CTCSS Event-Triggered Macros

Any COR or CTCSS input can trigger high-to-low transition macros and low-to-high transition macros. In that respect, COR and CTCSS inputs are similar to logic inputs (you'll find the COR and CTCSS inputs listed along with the general-purpose logic inputs in the Logic Input chapter).

A high-to-low transition occurs when the voltage at the COR or CTCSS input pin changes from high (above a two-volt threshold) to low (below the threshold). A low-to-high transition is exactly the reverse. A COR or CTCSS input's inversion jumper has no effect as far as the event macros are concerned.

A hardware description of the COR and CTCSS inputs is found in the Installation chapter.

The ability of a COR or CTCSS input to act as a logic input is not affected by other programming such as Path Mode, COR/CTCSS Filter, Anti-Kerchunker, Flutter Filter, and so on.

Since the COR Simulate and CTCSS Simulate commands affect the COR and CTCSS inputs just like hardware does, entering a Simulate command will trigger the input's event-triggered macros.

You can do things like turn on and off external devices with COR and CTCSS transitions by using their event macros to control logic outputs. By having the COR and CTCSS inputs trigger macros related to receiver activity, we save the general-purpose logic inputs for things such as site power fail detection.

---



---

## Assign Macros to COR Inputs

Assigns macros to COR input transitions.

- Enter the password, the two-digit root number, the four-digit event-triggered macro number, and the macro name.
- If the macro name has fewer than four digits, enter leading zeroes.
- To unassign a previously-assigned macro, omit the macro name in the command.

---



---

### Command Form:

Command	Form
Assign Macro to COR1 Hi-to-Lo Transition	(PW) 26 0115 (macro name) *
Assign Macro to COR1 Lo-to-Hi Transition	(PW) 26 0116 (macro name) *
Assign Macro to COR2 Hi-to-Lo Transition	(PW) 26 0215 (macro name) *
Assign Macro to COR2 Lo-to-Hi Transition	(PW) 26 0216 (macro name) *
Assign Macro to COR3 Hi-to-Lo Transition	(PW) 26 0315 (macro name) *
Assign Macro to COR3 Lo-to-Hi Transition	(PW) 26 0316 (macro name) *

**Acknowledgment:** Sends *OK* message

### Errors:

Error	Meaning
? err 1	wrong number of digits entered
? err 2	illegal digit entered

**Default:** No macros assigned.

### Example:

To assign macro 0050 to COR1's low-to-high transition, enter:

```
(PW) 26 0116 0050 *
```

---



---

## Assign Macros to CTCSS Inputs

Assigns macros to CTCSS input transitions.

- Enter the password, the two-digit root number, the four-digit event-triggered macro number, and the macro name.
- If the macro name has fewer than four digits, enter leading zeroes.
- To unassign a previously-assigned macro, omit the macro name in the command.

---



---

### Command Form:

Command	Form
Assign Macro to CTCSS1 Hi-to-Lo Transition	(PW) 26 0117 (macro name) *
Assign Macro to CTCSS1 Lo-to-Hi Transition	(PW) 26 0118 (macro name) *
Assign Macro to CTCSS2 Hi-to-Lo Transition	(PW) 26 0217 (macro name) *
Assign Macro to CTCSS2 Lo-to-Hi Transition	(PW) 26 0218 (macro name) *
Assign Macro to CTCSS3 Hi-to-Lo Transition	(PW) 26 0317 (macro name) *
Assign Macro to CTCSS3 Lo-to-Hi Transition	(PW) 26 0318 (macro name) *

**Acknowledgment:** Sends *OK* message

### Errors:

Error	Meaning
? err 1	wrong number of digits entered
? err 2	illegal digit entered

**Default:** No macros assigned.

### Example:

To assign macro %234+to CTCSS3 high-to-low transition, enter:

```
(PW) 26 0317 1234 *
```



## COR Pulse-Triggered Macros

Each COR input can trigger a macro when it receives one or more correctly-timed pulses (the CTCSS inputs do not have this ability).

This PTM (Pulse-Triggered Macro) feature isn't normally found in repeater controllers; it's borrowed from S-COM's aviation base station controllers. (General aviation pilots can control landing lights and other equipment at unattended airstrips by keying the microphone PTT button multiple times in succession.)

The PTM feature can be valuable because users can signal the controller without having to send any DTMF digits. For example, a user pressing his PTT button five times 1 second on and 1 second off can cause the controller to transmit an emergency tone page or activate a link so help can be summoned or change the repeater access from CTCSS to carrier for a period of time determined by the activity timer.

The controller must be able to recognize a series of intentionally-sent pulses among noise, kerchunks, and normal conversation transmissions. This is done with two programmable timers, one to measure pulse width and one to measure the time between pulses. Since humans usually aren't very good at judging whether they've held the PTT button for, say, one-half second, you may want to experiment with various pulse and gap rhythms to make sure the parameters you choose work for your users.

### The PTM Algorithm

The PTM algorithm helps ensure that valid pulses are counted and invalid pulses are ignored.

Here's how it works:

The Minimum Pulse Duration timer decides whether or not a pulse is valid. A pulse shorter than the minimum duration is invalid and is ignored regardless of whether it occurs before or during the counting process.

Counting begins with the first valid pulse. After the pulse is received, the Maximum Gap Duration timer starts. To be counted, the next valid pulse must be received before the Maximum Gap timer expires. When the timer finally expires, the algorithm assumes the operator is finished making pulses. It then triggers the macro corresponding to the number of pulses counted.

For example, let's say the Minimum Pulse Duration is  $\frac{1}{4}$  second (250 ms) and the Maximum Gap Duration is 2 seconds (2000 ms). If a user presses the mic

---

button for at least  $\frac{1}{4}$  second and sends four of these  $\frac{1}{4}$ -second pulses with each one sent within 2 seconds of the previous one, the macro assigned to a pulse count of four is triggered.

If instead the user sends a  $\frac{1}{4}$ -second pulse but waits 3 seconds before starting the second pulse, the algorithm exits with a count of 1 pulse exactly 2 seconds after the user finishes the first pulse.

Because the Minimum Pulse Duration is  $\frac{1}{4}$  second, any pulses less than  $\frac{1}{4}$  second are ignored.

The COR Pulse-Triggered Macro feature runs independently of the Path Access Mode, COR Filter, Anti-Kerchunker, Flutter Filter, etc.

---

**Note: This command has been changed slightly from the S-COM 7K Controller.** *Maximum Gap Duration* replaces the *Window Time* parameter in the 7K version. *Window Time* was the overall time allowed for all the pulses to be counted. *Maximum Gap* is the maximum time allowed between pulses. This new definition improves the reliability of pulse detection.

---

---



---

## Assign COR Pulse-Triggered Macros

Assigns macros to be executed on receipt of COR input pulses.

- Enter the password, the two-digit root number, the four-digit event-triggered macro number, and the macro name.
  - If the macro name has fewer than four digits, enter leading zeroes.
  - To unassign a previously-assigned macro, omit the macro name.
- 
- 

### Command Form:

Command	Form
Assign COR Pulse-Triggered Macro for 1 Pulse on COR1	(PW) 26 0171 (macro name) *
Assign COR Pulse-Triggered Macro for 2 Pulses on COR1	(PW) 26 0172 (macro name) *
Assign COR Pulse-Triggered Macro for 3 Pulses on COR1	(PW) 26 0173 (macro name) *
Assign COR Pulse-Triggered Macro for 4 Pulses on COR1	(PW) 26 0174 (macro name) *
Assign COR Pulse-Triggered Macro for 5 Pulses on COR1	(PW) 26 0175 (macro name) *
Assign COR Pulse-Triggered Macro for 6 Pulses on COR1	(PW) 26 0176 (macro name) *
Assign COR Pulse-Triggered Macro for 7 Pulses on COR1	(PW) 26 0177 (macro name) *
Assign COR Pulse-Triggered Macro for 8 Pulses on COR1	(PW) 26 0178 (macro name) *
Assign COR Pulse-Triggered Macro for 9 Pulses on COR1	(PW) 26 0179 (macro name) *

Command	Form
Assign COR Pulse-Triggered Macro for 1 Pulse on COR2	(PW) 26 0271 (macro name) *
Assign COR Pulse-Triggered Macro for 2 Pulses on COR2	(PW) 26 0272 (macro name) *
Assign COR Pulse-Triggered Macro for 3 Pulses on COR2	(PW) 26 0273 (macro name) *
Assign COR Pulse-Triggered Macro for 4 Pulses on COR2	(PW) 26 0274 (macro name) *
Assign COR Pulse-Triggered Macro for 5 Pulses on COR2	(PW) 26 0275 (macro name) *
Assign COR Pulse-Triggered Macro for 6 Pulses on COR2	(PW) 26 0276 (macro name) *
Assign COR Pulse-Triggered Macro for 7 Pulses on COR2	(PW) 26 0277 (macro name) *
Assign COR Pulse-Triggered Macro for 8 Pulses on COR2	(PW) 26 0278 (macro name) *
Assign COR Pulse-Triggered Macro for 9 Pulses on COR2	(PW) 26 0279 (macro name) *

<b>Command</b>	<b>Form</b>
Assign COR Pulse-Triggered Macro for 1 Pulse on COR3	(PW) 26 0371 (macro name) *
Assign COR Pulse-Triggered Macro for 2 Pulses on COR3	(PW) 26 0372 (macro name) *
Assign COR Pulse-Triggered Macro for 3 Pulses on COR3	(PW) 26 0373 (macro name) *
Assign COR Pulse-Triggered Macro for 4 Pulses on COR3	(PW) 26 0374 (macro name) *
Assign COR Pulse-Triggered Macro for 5 Pulses on COR3	(PW) 26 0375 (macro name) *
Assign COR Pulse-Triggered Macro for 6 Pulses on COR3	(PW) 26 0376 (macro name) *
Assign COR Pulse-Triggered Macro for 7 Pulses on COR3	(PW) 26 0377 (macro name) *
Assign COR Pulse-Triggered Macro for 8 Pulses on COR3	(PW) 26 0378 (macro name) *
Assign COR Pulse-Triggered Macro for 9 Pulses on COR3	(PW) 26 0379 (macro name) *

**Acknowledgment:** Sends *OK* message

**Errors:**

<b>Error</b>	<b>Meaning</b>
? err 1	wrong number of digits entered
? err 2	illegal digit entered

**Default:** No macros are assigned.

**Examples:**

To execute macro 1234 when 3 COR pulses are detected on RX2 within the defined window, enter:

(PW) 26 0273 1234 \*

---



---

## Select COR PTM Minimum Pulse Duration

Selects the minimum time a user must press the PTT for a valid pulse.

- Enter the password, the two-digit root number, the four-digit timer number, and one to five digits from 0 to 65535 to set the time to 0.00 to 655.35 seconds.

---



---

### Command Form:

Command	Form	Data Digit
Select COR1 Pulse Minimum Duration	(PW) 09 0110 xxxxx *	xxxxx = 0-65535 = 0-655.35 seconds
Select COR2 Pulse Minimum Duration	(PW) 09 0210 xxxxx *	
Select COR3 Pulse Minimum Duration	(PW) 09 0310 xxxxx *	

**Acknowledgment:** Sends *OK* message

### Errors:

Error	Meaning
? err 1	wrong number of digits entered
? err 2	illegal digit entered

**Default:** The minimum pulse duration is 0.25 seconds

### Example:

To set a minimum pulse width of 0.30 seconds for RX1 COR, enter:

```
(PW) 09 0110 30 *
```

---



---

## Select COR PTM Maximum Gap Duration

Selects the maximum time allowed between pulses.

- Enter the password, the two-digit root number, the four-digit timer number, and one to five digits from 0 to 65535 to set the time to 0.00 to 655.35 seconds.

---



---

### Command Form:

Command	Form	Data Digit
Select COR1 Maximum Gap between pulses	(PW) 09 0111 xxxxx *	xxxxx = 0-65535 = 0-655.35 seconds
Select COR2 Maximum Gap between pulses	(PW) 09 0211 xxxxx *	
Select COR3 Maximum Gap between pulses	(PW) 09 0311 xxxxx *	

**Acknowledgment:** Sends *OK* message

### Errors:

Error	Meaning
? err 1	wrong number of digits entered
? err 2	illegal digit entered

**Default:** The Maximum Gap is 2.00 seconds

### Example:

To set a maximum gap of 1.5 seconds for RX1 COR, enter:

```
(PW) 09 0111 150 *
```

## Receiver Enable/Disable

The 7330 implements multiple levels of path control to provide lots of flexibility in programming. The Receiver Enable/Disable commands follow the receiver filters and are ahead of the receiver-to-transmitter path enables and access modes defined in the Path Chapter (see page 9-1).

The Receiver Enable/Disable commands provide control of the receiver the same way that the Transmitter PTT Enable/Disable commands provide control of the transmitter. These commands together can be used to disable a port during service or troubleshooting. Flashing LEDs indicate that the receiver is disabled.

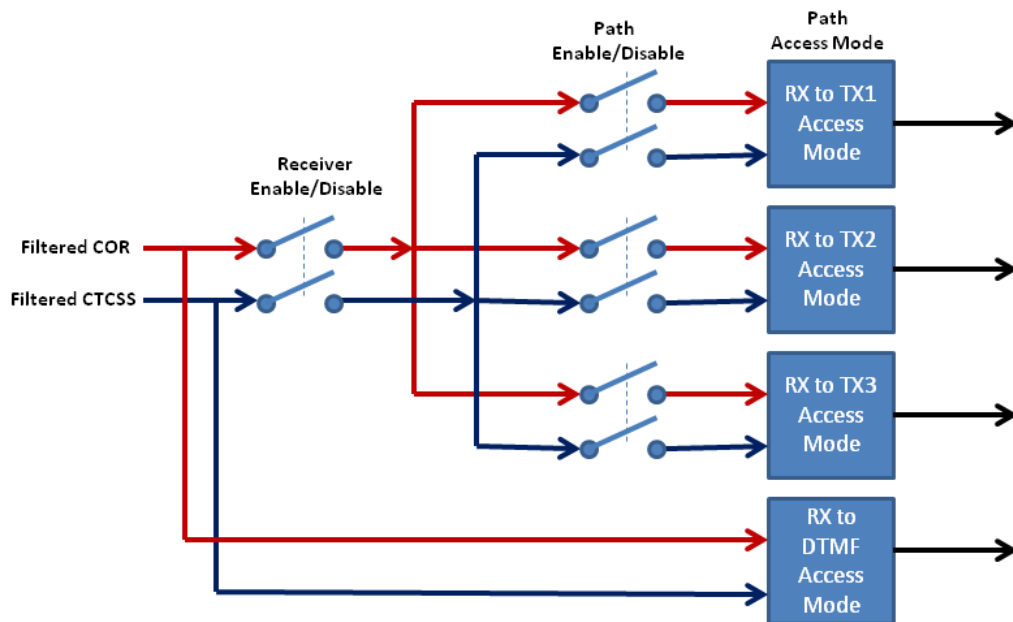

---



---

## Enable/Disable Receiver

Turns ON or OFF the connection from a receiver to all receiver-to-transmitter paths.

- Does not affect the receiver-to-DTMF path.
  - Enabling or disabling a receiver does not affect the programmed Path Enable or Path Access Mode for any of the receiver-to-transmitter paths.
  - COR and CTCSS LEDs alternately glow to indicate that the receiver is disabled.
  - Enter the password, the two-digit root number, the four-digit software switch number, and one digit (0 to disable the path, 1 to enable it).
- 
- 

### Command Form:

Command	Form	Data Digit
Enable/Disable Receiver #1	(PW) 63 0119 x *	0 = OFF (disabled) 1 = ON (enabled)
Enable/Disable Receiver #2	(PW) 63 0219 x *	
Enable/Disable Receiver #3	(PW) 63 0319 x *	

**Acknowledgment:** Sends *OK* message

### Errors:

Error	Meaning
? err 1	wrong number of digits entered
? err 2	illegal digit entered

**Default:** All Receivers are ON (enabled)

### Examples:

To disable all receiver #2-to-transmitter paths with a single command, enter:

```
(PW) 63 0219 0 *
```

To enable it again, enter:

```
(PW) 63 0219 1 *
```



---

## Chapter 11

# Transmitter Commands

---

Transmitter-related commands appear in this chapter and in Chapter 9, *Paths*.

In this chapter we'll first describe how the transmitter tail sequence works in general, then we'll describe these features in detail:

1. **Front Panel LEDs**
  2. **Transmitter Turn-On Message Delay**
  3. **Courtesy Delay** and **Courtesy Delay Violation Macro**
  4. **Dropout Delay**, **Dropout Message**, and **Dropout Macro**
  5. **Transmitter PTT Unkey Delay**
  6. **Transmitter PTT-Triggered Macro**
  7. **Transmitter End-of-Activity Counter/Timer**
  8. **Transmitter Start-of-Activity Macro** and **End-of-Activity Macro**
  9. **Enable/Disable Transmitter PTT**
  10. **Timed and Untimed Transmitter Key**
  11. **Path-to-Transmitter Macro**
  12. **Transmitter Tone Generator**
-

## Front Panel PTT LEDs

The front panel display includes an LED for each Transmitter PTT (Push-to-Talk) output.

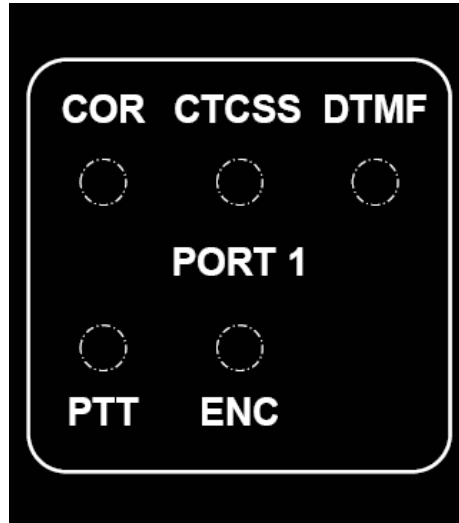

A glowing LED means the controller is activating the PTT output. A flashing LED means that the controller would activate the PTT output but the output has been disabled by the Enable/Disable Transmitter PTT command on page 11-25.

LED State	Meaning
OFF	PTT not keyed
ON	PTT keyed
Flashing	PTT would be keyed if transmitter PTT was enabled

The actual hardware output state may be either high or low, depending on whether or not the PTT inversion jumper is in place. (See Appendix B, Installation, Transmitter PTT, page B-5.)

## Transmitter Tail Sequence

The 7330 offers a number of commands that you can use to set up the transmitter tail sequence. *Figure 11-1* will help you understand them -- see *Figure 11-1* on the next page.

### Courtesy Delay and Path Courtesy Message

When a user unkeys the microphone, the *Courtesy Delay* starts. When the delay ends, the *Path Courtesy Message* is sent and the *Path Timeout Timer* is reset. (The Courtesy Message and Timeout Timer are defined by the path, not the transmitter, so you'll find their descriptions in Chapter 9, *Paths*.)

### Dropout Delay and Dropout Message

When the Courtesy Delay ends, the *Dropout Delay* starts. When the Dropout Delay ends, the *Dropout Message* is sent. (The Dropout Delay is sometimes called the Transmitter Hang Time or Carrier Delay.)

### Path Timeout Timer and Path Timeout Message

If a station transmits for a longer period than the *Path Timeout Timer* allows, the *Path Timeout Message* is sent and the path is disabled, unkeying the transmitter. (The Path Penalty Timer and Path Timeout Message are described in Chapter 9.)

### Transmitter Unkey Delay

The *Transmitter Unkey Delay* starts when the Dropout Delay ends and guarantees that the transmitter is keyed for a minimum amount of time after path activity stops.

### CTCSS Reverse Burst

The *CTCSS Reverse Burst* delay keeps the transmitter keyed for the *CTCSS Reverse Burst Time*, if enabled. See Chapter 13, *CTCSS Encoder*, to set this time.

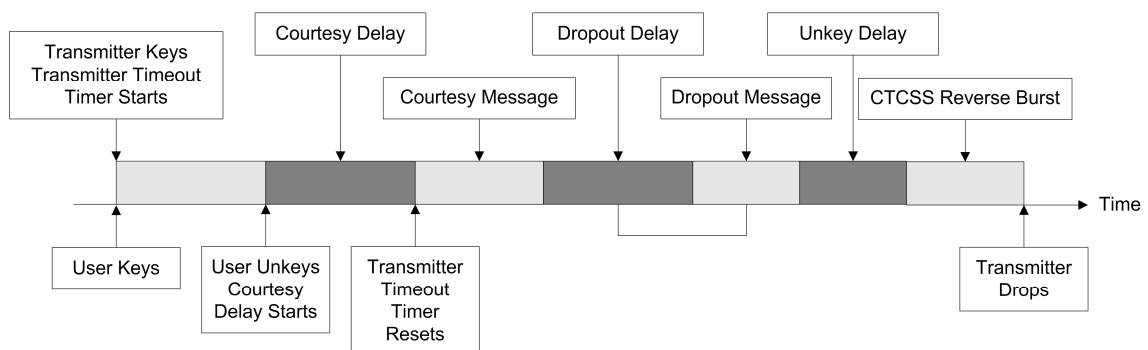

Figure 11-1 - The Transmitter Tail sequence

## Tip: Setting Transmitter Tail Timing

The delays you select for each part of the tail timing depends on personal taste and the type of use for the transmitter.

### Repeater Transmitter Tail Timing

The 7330 defaults are appropriate for a typical repeater transmitter. You can adjust the delays to match your personal tastes.

### Link/Remote Base Transmitter Tail Timing

Link and remote base transmitters are assumed to work differently and to sound different than a repeater transmitter. Typically, they drop out immediately after the user stops transmitting, and they usually don't transmit tail beeps, identifier messages, and other automated announcements.

To configure a 7330 port for typical link or remote base transmitter use, you'd want to make the following changes (example shown for transmitter 3):

```
; disable the IDer
(PW) 09 2306 0 * ; TX3

; Set Courtesy Delay to zero
(PW) 09 0300 0 * ; TX3

; Delete the Courtesy Messages
(PW) 31 0300 * ; RX1-TX3
(PW) 31 0301 * ; RX2-TX3
(PW) 31 0302 * ; RX3-TX3

; Set Dropout Delay to zero
(PW) 09 0301 0 * ; TX3

; Delete the Dropout Message
(PW) 31 0312 * ; TX3

; Set Minimum Unkey Delay to zero
(PW) 09 0302 0 * ; TX3

; Turnoff CTCSS Reverse Burst
(PW) 02 w x 0 * : TX3, Control CTCSS Encoder
```

## Transmitter Turn-On Message Delay

The *Transmitter Turn-On Message Delay* is a timer that starts when the controller initially activates a PTT output. The controller waits for it to expire before sending any messages that may be queued in the transmitter's message buffer.

The delay serves two purposes: It lets the transmitter come up to full power before starting the message and it allows time for CTCSS decoders to unmute listeners/receivers. By allowing a little time for those delays we help ensure that the message is correctly heard.

The Turn-On Message Delay only affects messages. It does not affect PTT timing or receiver-to-transmitter audio gating in any way. It's listed in this chapter because it's a transmitter-related function.

---



---

## Select Transmitter Turn-On Message Delay

Delays messages briefly when transmitter is initially keyed.

- Enter the password, the two-digit root number, four-digit timer number and one to five digits from 0 to 65535 to set the delay to 0.00 to 655.35 seconds.
  - To disable the delay, set its value to 0.
- 
- 

### Command Form:

Command	Form	Data Digit
Select TX1 Turn-On Message Delay	(PW) 09 0103 xxxxx *	xxxxx = 0-65535 = 0-655.35 seconds
Select TX2 Turn-On Message Delay	(PW) 09 0203 xxxxx *	
Select TX3 Turn-On Message Delay	(PW) 09 0303 xxxxx *	

**Acknowledgment:** Sends *OK* message

### Errors:

Error	Meaning
? err 1	wrong number of digits entered
? err 2	illegal digit entered

**Default:** Transmitter Turn-On Message Delay is 0.25 seconds.

### Example:

To set TX2's Turn-On Message Delay to 100 milliseconds (0.10 second), enter:

```
(PW) 09 0203 10 *
```

The default delay of 0.25 seconds is appropriate for solid-state transmitters and users listening with carrier squelched receivers. For use with tube-type transmitters or users using CTCSS decoders, set the delay to a longer time, maybe 1.00 seconds.

To set TX1's Turn-On Message Delay to 1000 milliseconds (1.00 second), enter:

```
(PW) 09 0103 100 *
```

## Courtesy Delay

The *Courtesy Delay* starts when a path goes inactive (such as when a user unkeys). When it ends, the *Courtesy Message* is sent and the *Path Timeout Timer* is reset. See Figure 11-1.

A modest courtesy delay can convince users to allow more time between transmissions, making it easier for other stations to break in. That's because a user who transmits without waiting for the Courtesy Message hasn't reset the timeout timer and runs the risk of timing out the repeater. (For this reason, resetting the Path Timeout Timer at the end of the Courtesy Delay is sometimes called an anti-tailgating measure. The offending station must wait out the timeout penalty time, then repeat the portion of his transmission that was lost.)

Transmitters used in half-duplex links and remote bases may need to drop as soon as the path drops, so the Courtesy Delay can be set to zero (which means the Path Timeout Timer resets immediately on path drop) and the Courtesy Message can be deleted.

---



---

## Select Courtesy Delay

Programs the Courtesy Delay time value.

- Enter the password, the two-digit root number, the four-digit timer number and one to five digits from 0 to 65535 to set the delay to 0.00 to 655.35 seconds.

---



---

### Command Form:

Command	Form	Data Digit
Select TX1 Courtesy Delay	(PW) 09 0100 xxxxx *	xxxxx = 0-65535 = 0-655.35 seconds
Select TX2 Courtesy Delay	(PW) 09 0200 xxxxx *	
Select TX3 Courtesy Delay	(PW) 09 0300 xxxxx *	

**Acknowledgment:** Sends *OK* message

### Errors:

Error	Meaning
? err 1	wrong number of digits entered
? err 2	illegal digit entered

**Default:** The Courtesy Delay is 0.50 seconds.

### Examples:

To select a 1.5-second TX3 Courtesy Delay, enter:

```
(PW) 09 0300 150 *
```

To eliminate the TX2 Courtesy Delay, enter:

```
(PW) 09 0200 0 *
```



## Courtesy Delay Violation Macro

You can assign a macro that executes if a user keys up before the Courtesy Delay expires. Use the macro to warn your users that they are keying too quickly after the preceding transmission, or tailgating.

The Courtesy Delay Violation Macro is an event-triggered macro and is executed if a path goes from inactive to active while the Courtesy Delay timer is still running.

---



---

## Assign Courtesy Delay Violation Macro

Assigns a macro to the Courtesy Delay Violation event.

- Enter the password, the two-digit root number, the four-digit event-triggered macro number, and the four-digit macro name desired. Use leading zeros if needed.
  - To unassign a previously assigned macro, enter just the password, the two-digit root number, the four-digit event-triggered macro number, and the (\*).
- 
- 

### Command Form:

Command	Form
Assign TX1 Courtesy Timer Violation Macro	(PW) 26 0119 (macro name) *
Assign TX2 Courtesy Timer Violation Macro	(PW) 26 0219 (macro name) *
Assign TX3 Courtesy Timer Violation Macro	(PW) 26 0319 (macro name) *

**Acknowledgment:** Sends *OK* message

### Errors:

Error	Meaning
? err 1	wrong number of digits entered
? err 2	illegal digit entered

**Default:** No macros assigned.

### Example:

To assign macro 0250 to TX1 to Courtesy Timer Violation event, enter:

```
(PW) 26 0119 0250 *
```

## Dropout Delay

The *Dropout Delay* starts when the *Courtesy Delay* ends. When the Dropout Delay ends the transmitter unkeys. See Figure 11-1.

Repeater owners have been using long Dropout Delays for years to extend the life of relays and tubes in tube-type transmitters. A long dropout allows users to wait for the Courtesy Message and still transmit before the repeater transmitter unkeys, resulting in fewer on and off keying cycles. With today's solid-state transmitters, Dropout Delay is mostly up to personal preference.

Transmitters used in half-duplex links and remote bases may need to drop as soon as the path drops, so the Dropout Delay can be set to zero.

---



---

## Select Dropout Delay

Programs the Dropout Delay time value.

- Enter the password, the two-digit root number, the four-digit timer number and one to five digits from 0 to 65535 to set the delay to 0.00 to 655.35 seconds.
- To disable the delay, set its value to 0.

---



---

### Command Form:

Command	Form	Data Digit
Select TX1 Dropout Delay	(PW) 09 0101 xxxxx *	xxxxx = 0-65535 = 0-655.35 seconds
Select TX2 Dropout Delay	(PW) 09 0201 xxxxx *	
Select TX3 Dropout Delay	(PW) 09 0301 xxxxx *	

**Acknowledgment:** Sends *OK* message

### Errors:

Error	Meaning
? err 1	wrong number of digits entered
? err 2	illegal digit entered

**Default:** Dropout Delay is 3.0 seconds

### Examples:

To set TX1's Dropout Delay to 2.5 seconds, enter:

```
(PW) 09 0101 250 *
```

To set TX2's Dropout Delay to 0.1 second, enter:

```
(PW) 09 0201 10 *
```

## Dropout Message

### Dropout Message Time

The Dropout Message is sent at the end of the Dropout Delay, after which the transmitter unkeys. The commands on the next page are used to program and play back the Dropout Message for each transmitter.

The Dropout Message may contain any combination of message types, including CW, beeps, page tones, digital audio files, and so on. It can be used to remind users of the status of the machine, an approaching net or meeting, or the current time. Or, it can be silenced by programming no message at all.

The Dropout Message is a convenient time during a conversation on a repeater to insert an announcement like a %grandfather clock+time announcement. But hearing the time anytime the transmitter is allowed to drop, which could be quite often, would be more annoying than most repeater users would tolerate.

To reduce the frequency of occurrence of the Dropout Message, set the Dropout Message Time to the minimum interval between times when the message is to be played.

---



---

## Select/Review Dropout Message

Programs or reviews the Dropout Message

- To program a message, enter the password, the two-digit root number, the four-digit message number, and the message.
- To delete a message, enter the command but omit the message.
- To review a message, enter the password, the two-digit root number, and the four-digit message number.

---



---

### Command Form:

Command	Form	Default
Select TX1 Dropout Message	(PW) 31 0112 (message) *	No message
Select TX2 Dropout Message	(PW) 31 0212 (message) *	
Select TX3 Dropout Message	(PW) 31 0312 (message) *	
Review TX1 Dropout Message	(PW) 34 0112 *	
Review TX2 Dropout Message	(PW) 34 0212 *	
Review TX3 Dropout Message	(PW) 34 0312 *	

**Acknowledgment:** Sends *OK* message

### Errors:

Error	Meaning
? err 1	wrong number of digits entered
? err 2	illegal digit entered

**Default:** No message

### Examples:

Assume a Skywarn net is in progress and you want TX1's Dropout Message to be %W/X+in CW. Enter:

```
(PW) 31 0112 9900 32 33 *
```

---



---

## Select Dropout Message Time

Programs the Dropout Message time.

- Enter the password, the two-digit root number, the four-digit timer number, and one to five digits, 0 to 65535 to set the message time to 0 to 65535 seconds.
  - When set to 0, the *Dropout Message* will be heard on every transmitter tail.
- 
- 

### Command Form:

Command	Form	Data Digit
Select Dropout Message Time for TX1	(PW) 09 2111 xxxxx *	xxxxx = (0-65535) = (0-65535) seconds
Select Dropout Message Time for TX2	(PW) 09 2211 xxxxx *	
Select Dropout Message Time for TX3	(PW) 09 2311 xxxxx *	

**Acknowledgment:** Sends *OK* message

### Errors:

Error	Meaning
? err 1	wrong number of digits entered
? err 2	illegal digit entered

**Default Condition:** Dropout Message Time is 0 seconds. The Dropout Message will be heard on every transmitter tail.

### Examples:

To play a message on the tail of transmitter #1 no more frequently than every 5 minutes, enter:

```
(PW) 09 2111 300 *
```

## Dropout Macro

You can assign an event-triggered macro that executes at the end of the Dropout Delay.

The Dropout Macro is executed at the same time the Dropout Message is queued.



---



---

## Assign Dropout Macro

Assigns macro to transmitter dropout event.

- Enter the password, the two-digit root number, the four-digit event-triggered macro number, and the macro name.
  - If the macro name has fewer than four digits, enter leading zeroes.
  - To unassign a previously-assigned macro, enter just the password, the two-digit root number, the four-digit event-triggered macro number, and the (\*).
- 
- 

### Command Form:

Command	Form
Assign TX1 Dropout Macro	(PW) 26 0104 (macro name) *
Assign TX2 Dropout Macro	(PW) 26 0204 (macro name) *
Assign TX3 Dropout Macro	(PW) 26 0304 (macro name) *

**Acknowledgment:** Sends *OK* message

### Errors:

Error	Meaning
? err 1	wrong number of digits entered
? err 2	illegal digit entered

**Default:** No macros assigned.

### Example:

To assign macro %25+ to the TX1 dropout event, enter:

```
(PW) 26 0104 0125 *
```

## **PTT Minimum Unkey Delay**

The *PTT Minimum Unkey Delay* is a timer that starts at the end of the *Dropout Delay*. The transmitter PTT line is released when it expires.

It is normally a very short delay that holds off releasing the PTT until it appears there are no requests to keep the transmitter keyed. The requests can come from messages, path activity, command requests, and so on, and by filtering the PTT output with this delay we prevent short key-ups that might occur.

Transmitters used in half-duplex links and remote bases may need to drop as soon as the path drops, so the PTT Unkey Delay can be set to zero.

---



---

## Select Transmitter PTT Minimum Unkey Delay

Programs the minimum amount of time for a transmitter PTT to be keyed before unkeying.

- Enter the password, the two-digit root number, the four-digit timer number, and one to five digits from 0 to 65535 to set the delay to 0.00 to 655.35 seconds.
  - To disable the delay, set the timer to zero.
- 
- 

### Command Form:

Command	Form	Data Digit
Select TX1 Minimum Unkey Delay	(PW) 09 0102 xxxxx *	xxxxx = 0-65535 = 0-655.35 seconds
Select TX2 Minimum Unkey Delay	(PW) 09 0202 xxxxx *	
Select TX3 Minimum Unkey Delay	(PW) 09 0302 xxxxx *	

**Acknowledgment:** Sends *OK* message

### Errors:

Error	Meaning
? err 1	wrong number of digits entered
? err 2	invalid timer or seconds parameter

**Default:** The *Minimum Unkey Delay* is 0.10 second.

### Example:

To set the TX2 Minimum Unkey Delay to 0.20 seconds, enter:

(PW) 09 0202 20 \*

## PTT Macros

The commands on the next page describe event-triggered macros that execute at three stages of the transmitter's PTT sequence.

The Inactive-to-Active Macro executes when the transmitter is keyed.

The Active-to-Inactive Before Unkey Delay Macro executes at the start of the PTT Unkey Delay. Since the Unkey Delay is programmable, the macro is executed a programmable amount of time before the transmitter is unkeyed.

The Active-to-Inactive After Unkey Delay Macro executes when the transmitter is unkeyed.

These macros are provided for those who need to do such things as generate a message, control a logic output, start a timer, or synchronize an external device to the PTT line.

For example, the Inactive-to-Active macro can turn on a cooling fan, and one of the Active-to-Inactive macros can activate a *User Timer* to turn it off after a delay.

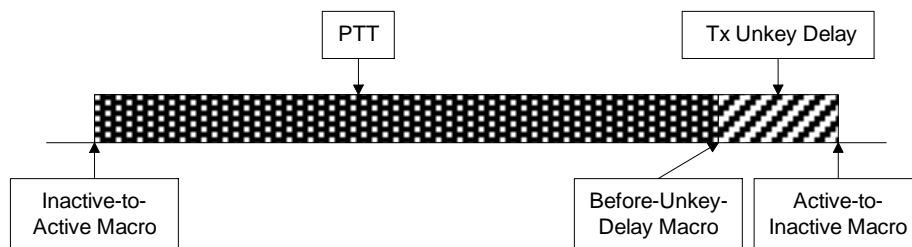

---



---

## Assign Transmitter PTT Macros

Assigns macros to PTT active and PTT inactive events.

- Enter the password, the two-digit root number, the four-digit event-triggered macro number, and the four-digit macro name desired. Use leading zeros if needed.
  - To unassign a previously assigned macro, enter just the password, the two-digit root number, the four-digit event-triggered macro number, and the (\*).
- 
- 

### Command Form:

Command	Form
Assign TX1 PTT Inactive-to-Active Macro	(PW) 26 0105 (macro name) *
Assign TX1 PTT Active-to-Inactive Before Unkey Delay Macro	(PW) 26 0106 (macro name) *
Assign TX1 PTT Active-to-Inactive After Unkey Delay Macro	(PW) 26 0107 (macro name) *
Assign TX2 PTT Inactive-to-Active Macro	(PW) 26 0205 (macro name) *
Assign TX2 PTT Active-to-Inactive Before Unkey Delay Macro	(PW) 26 0206 (macro name) *
Assign TX2 PTT Active-to-Inactive After Unkey Delay Macro	(PW) 26 0207 (macro name) *
Assign TX3 PTT Inactive-to-Active Macro	(PW) 26 0305 (macro name) *
Assign TX3 PTT Active-to-Inactive Before Unkey Delay Macro	(PW) 26 0306 (macro name) *
Assign TX3 PTT Active-to-Inactive After Unkey Delay Macro	(PW) 26 0307 (macro name) *

**Acknowledgment:** Sends OK message

### Errors:

Error	Meaning
? err 1	wrong number of digits entered
? err 2	illegal digit entered

**Default:** No macros are assigned.

### Example:

To execute macro 0019 when TX3 PTT goes active, enter:

```
(PW) 26 0305 0019 *
```

## Start-of-Activity and End-of-Activity

The Start-of-Activity and End-of-Activity Macros execute at the start and end of a conversation, respectively, and work as a pair like bookends. The Start-of-Activity Macro, once executed, won't execute again until the End-of-Activity Macro executes.

The End-of-Activity Timer and Counter let you choose how long after a conversation, and how often, you want to execute the End-of-Activity Macro.

For example, to record all repeater conversations, you could use the Start-of-Activity Macro to start the recorder. Set the counter to zero to avoid missing any repeater activity. (Setting the counter to zero means the End-of-Activity Macro will execute at each activity cycle. Setting the counter to 1 causes the macro to execute every other activity cycle, and setting it to 9 causes the macro to execute every tenth cycle.) Finally, program a short delay into the timer so the recorder doesn't stop and start when users let the repeater drop between transmissions.

Perhaps you'd like to send a recorded bulletin or club announcement occasionally. If you don't want the announcement to be heard too often, set the counter to 4, which causes the recording to be sent every fifth conversation. And, set the Timer to something like 30 seconds. That way, not only are you assured of having an audience for your message (since End of Activity means a conversation just ended), but the 30-second delay helps ensure the conversation is really over and keeps the controller from sending the announcement on top of someone.

How it works: The *Start-of-Activity Macro* is executed when a fresh key-up occurs. This action starts an activity cycle that ends a certain time after the transmitter drops, set by the End-of-Activity Timer. If new activity occurs before the timer expires, the activity cycle is simply extended.

When the timer finally expires, and if the counter allows, the End-of-Activity Macro is executed. The counter, which watches the number of activity cycles, is programmable from 0 to 65,535 events. The timer is programmable from 0 to 65,535 seconds.

Once the End-of-Activity Macro executes, the activity cycle is complete and the Start-of-Activity Macro is re-armed and ready to execute at the next key-up. This is true regardless of whether the last End-of-Activity macro actually executed (it may have been at the wrong count).

---



---

## Select Transmitter End-of-Activity Counter/Timer

Selects the count value and timer value for the End-of-Activity Macro.

- Enter the password, the two-digit root number, the four-digit counter number, and one to five digits from 0 to 65535 to set the count value.
- Enter the password, the two-digit root number, the four-digit timer number, and one to five digits from 0 to 65535 to set the delay from 0 to 65535 seconds.

---



---

### Command Form:

Command	Form	Data Digit
Select TX1 End-of-Activity Counter	(PW) 45 0100 xxxxx *	x = event count = 0. 65535
Select TX1 End-of-Activity Timer	(PW) 09 2110 xxxxx*	xxxxx = 0-65535 = 0-65535 seconds
Select TX2 End-of-Activity Counter	(PW) 45 0200 xxxxx *	x = event count = 0. 65535
Select TX2 End-of-Activity Timer	(PW) 09 2210 xxxxx*	xxxxx = 0-65535 = 0-65535 seconds
Select TX3 End-of-Activity Counter	(PW) 45 0300 xxxxx *	x = event count = 0. 65535
Select TX3 End-of-Activity Timer	(PW) 09 2310 xxxxx*	xxxxx = 0-65535 = 0-65535 seconds

**Acknowledgment:** Sends OK message

### Errors:

Error	Meaning
? err 1	wrong number of digits entered
? err 2	illegal digit entered

**Default:** Count defaults to 0; Time defaults to 60 seconds

### Examples:

To set TX1's End-of-Activity Counter to 3 (every 4 occurrences) and Timer to 30 seconds, enter:

```
(PW) 45 0100 3 *
```

```
(PW) 09 2110 30 *
```

---



---

## Assign Transmitter Start-of-Activity and Transmitter End-of-Activity Macros

Assigns macros to starting and ending activity events.

- Enter the password, the two-digit root number, the four-digit event-triggered macro number, and the four-digit macro name desired. Use leading zeros if needed.
  - To unassign a previously assigned macro, enter just the password, the two-digit root number, the four-digit event-triggered macro number, and the (\*).
- 
- 

### Command Form:

Command	Form
Assign TX1 Start-of-Activity Macro	(PW) 26 0113 (macro name) *
Assign TX1 End-of-Activity Macro	(PW) 26 0114 (macro name) *
Assign TX2 Start-of-Activity Macro	(PW) 26 0213 (macro name) *
Assign TX2 End-of-Activity Macro	(PW) 26 0214 (macro name) *
Assign TX3 Start-of-Activity Macro	(PW) 26 0313 (macro name) *
Assign TX3 End-of-Activity Macro	(PW) 26 0314 (macro name) *

**Acknowledgment:** Sends OK message

### Errors:

Error	Meaning
? err 1	wrong number of digits entered
? err 2	illegal digit entered

**Default:** No macros are assigned

### Example:

To assign macro 5280 to TX1  $\Phi$  Start-of-Activity event, enter:

```
(PW) 26 0113 5280 *
```

To assign macro 5281 to TX1  $\Phi$  End-of-Activity event, enter:

```
(PW) 26 0114 5281 *
```



## **Enable/Disable Transmitter PTT**

Disabling the transmitter PTT is like cutting the PTT wire. All other functions are unaffected, but the transmitter PTT will not be keyed.

For example, receiver audio, identifications, courtesy messages, and other audio will continue to be fed to the transmitter's audio input, and activity macros will continue to execute.

When the transmitter PTT is disabled, the front panel PTT LED blinks as a reminder.

---



---

## Enable/Disable Transmitter PTT

Enables or disables the Transmitter PTT while not affecting other functions.

- Enter the password, the two-digit root number, the four-digit software switch number, and one digit (0 to disable the PTT, 1 to enable it).
- 
- 

### Command Form:

Command	Form	Data Digit
Enable/Disable TX1 PTT	(PW) 63 0112 x *	0 = OFF (disabled) 1 = ON (enabled)
Enable/Disable TX2 PTT	(PW) 63 0212 x *	
Enable/Disable TX3 PTT	(PW) 63 0312 x *	

**Acknowledgment:** Sends *OK* message

### Errors:

Error	Meaning
? err 1	wrong number of digits entered (disable only)
? err 2	illegal digit entered (disable only)

**Default:** All Transmitter PTTs are enabled

### Example:

To disable TX2 PTT, enter:

(PW) 63 0212 \*

## **Key Transmitter, Timed**

This command keys the transmitter for a specified period of time for testing or other purposes.

Re-entering the command with a time value of zero cancels the key request.

Re-entering the command with a new time value reloads the timer with the new value.

The key request will be ignored if the transmitter has been disabled with the Enable/Disable Transmitter PTT command. Disabling the transmitter while it is keyed via this command will cancel the key request.

---



---

## Key Transmitter (Timed)

Keys transmitter for the specified timed period.

- Enter the password, the two-digit root number, the four-digit timer number, and one to five digits from 0 to 65535 to set the time period to 0 to 65535 seconds.
  - To cancel the request, enter the password, the two-digit root number, the four-digit timer number, and **0+**.
- 
- 

### Command Form:

Command	Form	Data Digit
Key TX1 (Timed)	(PW) 09 2108 xxxxx *	xxxxx = 0-65535 = 0-65535 seconds
Key TX2 (Timed)	(PW) 09 2208 xxxxx *	
Key TX3 (Timed)	(PW) 09 2308 xxxxx *	

**Acknowledgment:** Sends *OK* message

### Errors:

Error	Meaning
? err 1	wrong number of digits entered
? err 2	illegal digits entered

**Default:** No key requests

### Example:

To key TX3 for 5 minutes (300 seconds), enter:

```
(PW) 09 2308 300 *
```

To cancel the key request, enter:

```
(PW) 09 2308 0 *
```

## **Key Transmitter, Untimed**

This command is a software switch that keys the transmitter for an indefinite period until cancelled.

The transmitter will not key if it has been disabled with the Enable/Disable Transmitter PTT command.

---



---

## Key Transmitter (Untimed)

Keys the specified transmitter until canceled.

- Enter the password, the two-digit root number, the four-digit software switch number, and one digit (1 to key, 0 to cancel).

---



---

### Command Form:

Command	Form	Data Digit
Key TX1 (Untimed)	(PW) 63 0113 x *	1 = key TX 0 = cancel
Key TX2 (Untimed)	(PW) 63 0213 x *	
Key TX3 (Untimed)	(PW) 63 0313 x *	

**Acknowledgment:** Sends *OK* message

### Errors:

Error	Meaning
? err 1	wrong number of digits entered
? err 2	illegal digit entered

**Default:** Transmitters are not requested to key

### Examples:

To key TX2, enter:

```
(PW) 63 0213 1 *
```

To cancel the key request, enter:

```
(PW) 63 0213 0 *
```

## **Path-to-Transmitter Macro**

You can assign event-triggered macros that execute on path-to-transmitter activity.

One macro executes when any path to the transmitter becomes active, and the other executes when the last path to the transmitter becomes inactive.

---



---

## Assign Path-to-Transmitter Macro

Assigns macros executed on path-to-transmitter activity.

- Enter the password, the two-digit root number, the four-digit event-triggered macro number, and the four-digit macro name desired. Use leading zeros if needed.
  - To unassign a previously assigned macro, enter just the password, the two-digit root number, the four-digit event-triggered macro number, and the (\*).
- 
- 

### Command Form:

Command	Form
Assign Macro to Any-Path-Active to TX1	(PW) 26 0102 (macro name) *
Assign Macro to All-Paths-Inactive to TX1	(PW) 26 0103 (macro name) *
Assign Macro to Any-Path-Active to TX2	(PW) 26 0202 (macro name) *
Assign Macro to All-Paths-Inactive to TX2	(PW) 26 0203 (macro name) *
Assign Macro to Any-Path-Active to TX3	(PW) 26 0302 (macro name) *
Assign Macro to All-Paths-Inactive to TX3	(PW) 26 0303 (macro name) *

**Acknowledgment:** Sends *OK* message

### Errors:

Error	Meaning
? err 1	wrong number of digits entered
? err 2	illegal digit entered

**Default:** No macros assigned

### Examples:

To assign macro 1546 to Any-Path-Active to TX1, enter:

```
(PW) 26 0102 1546 *
```

To assign macro 6505 to All-Paths-Inactive to TX1, enter:

```
(PW) 26 0103 6505 *
```



## Transmitter Tone Generator

Each transmitter has a built-in tone generator. By default, the tone generator is used by the Message Handler for cw, beeps, and paging. Using the command described here, the tone generator can be used for special applications. The tone is generated out the Tx Audio output of that port's radio interface.

Each tone generator can be set in one of three modes and off which lets the Message Handler use it exclusively.

- **A tone can be generated continuously.** This mode is useful for generating a test tone or for a special continuous tone application. While generating this tone, the message handler cannot generate messages. The PTT output is **not** automatically asserted in this mode. The tone is generated with and without PTT.
- **A tone can be generated whenever the transmitter is keyed.** This mode can be used as a dispatch console keying tone or in other cases when a tone must be present while audio is being transmitted. In this mode, the message handler cannot generate messages.
- **A tone can be generated whenever the transmitter is *not* keyed.** This mode is useful with some receiver voting systems that require a tone to be present when the transmitter is not keyed. The message handler is still enabled to generate messages in this mode.

---



---

## Control Transmitter Tone Generator

### Selects the tone generator operating mode

- In mode 0, the tone generator is used exclusively by the message handler.
  - In mode 1, the tone generator generates a tone continuously with and without the PTT. This mode does not control the PTT. The message handler does not generate messages.
  - In Mode 2, the tone generator turns ON when the PTT is keyed. The message handler does not generate messages.
  - In Mode 3, the tone generator turns OFF when the PTT is keyed. The message handler does generate messages.
  - Turn off the tone generator by setting the mode to 0.
  - Select a Message Level from the Message Level Table on page A-3.
  - Select a Tone Code from the Tone Code Table on page A-31.
- 
- 

### Command Form:

Command	Form	Data Digit
Control Transmitter Tone Generator	(PW) 79 t ww xx yyyy *	t = transmitter (1-3) ww = Mode xx = Message Level yyyy = Tone Code

### Modes:

Mode	Meaning
00	Tone generation is controlled exclusively by the Message Handler
01	Tone generated continuously
02	Tone generated when transmitter PTT is keyed
03	Tone generated when transmitter PTT is not keyed

**Acknowledgment:** Sends OK message

### Errors:

Error	Meaning
? err 1	wrong number of digits entered
? err 2	illegal digit entered

**Default Condition:** Tone generator is controlled exclusively by the Message Handler (Mode 0).

---

**Example 1:**

To generate a 1000 Hz test tone continuously at full amplitude on the Transmitter Audio Output on port 2 with and without the PTT, enter:

```
(PW) 79 2 01 00 0348 *
```

**Example 2:**

To generate a 2175 Hz tone at a message level of -20 dB when transmitter 3 is keyed, enter:

```
(PW) 79 3 02 40 0383 *
```

**Example 3:**

To generate a 1950 Hz tone at full amplitude when transmitter 3 is not keyed, enter:

```
(PW) 79 3 03 00 0338 *
```

**Example 4:**

To turn off the tone generator on port 1 to allow use by the Message Handler, enter:

```
(PW) 79 1 00 *
```

**Notes:**

---

## Chapter 12

# Identifier

---

The 7330 Controller supports separate *Identifiers* (ID) for each of the three transmitters. These identifiers are triggered by incoming signals from the users and identify the transmitters as required by the programming.

---

**Note:** Due to the separate identifiers feature, many of the commands and messages are specific to a particular transmitter. In the following text, all references to commands, messages, macros, and so forth, may not include distinctions for each transmitter. For example, we might refer to an *Initial ID Message* command, when, in fact, there are three commands that are similar: *Select Initial ID Message* for Tx1, and *Select Initial ID Message* for Tx2, and *Select Initial ID Message* for Tx3. Therefore, users should be careful to choose the proper command form on the command pages.

---

The Identifier can be configured as an *on-demand* or *usage-based* ID as used in the U.S. or as a *periodic* ID as required in other countries (sometimes called a *beacon* ID). To configure a beacon ID, see the example on page 12-11. Explanation of the on-demand ID follows here.

The 7330 on-demand identifier supports two different types of ID depending upon when the ID is sent during the course of a transmission. When a transmitter is keyed up after a period of silence and a transmission is underway, the first ID to be sent is called the *initial ID*. Thereafter, in this transmission each subsequent ID is a *Normal ID*. After the transmission is over and the final ID is sent, then the ID cycle starts all over again.

The on-demand identifier also supports the concept of a *polite* ID, meaning that the ID won't interrupt a transmission underway. At a specified time before an ID timeout expires (see *ID Pending Interval* below), the ID can be set up to be sent if the signal disappears.

Lastly, the 7330 also provides two types of Macros that are triggered after an ID depending upon whether the polite or impolite ID has been triggered. These are accordingly the polite and impolite ID macros.

## Identifier Sequence (On-demand)

If the initial signal is received continuously until the identifier timer expires, the *Initial ID Message* will be sent and the *Impolite ID Macro* will be executed. Normally, following the initial keyup, the *Initial ID Message* is sent and the *Initial ID Macro* is executed for each transmitter that was keyed

During a conversation, the controller looks for the input signal to drop during the *ID Pending Interval* prior to the expiration of the *ID Message Interval* timer. If the signal drops during this period, the *Normal ID Message* is sent and the *Polite ID Macro* is executed. If the signal does not drop by the time the *ID Message Interval* time expires, the *Impolite ID Message* is sent and the *Impolite ID Macro* is executed.

Because the controller looks ahead up to the *ID Pending Interval* time for the signal to drop (as required by the polite ID feature), the identification may not happen at precisely the same interval each time. If the *ID Message Interval* is set to 10 minutes and the *ID Pending Interval* is set to 30 seconds, for example, the identification can take place from 9 minutes 30 seconds to 10 minutes after the initial signal is received. The *Select ID Message Interval* command (see page 12-3) sets the *maximum* interval between identifications. The *Select ID Pending Interval* command (see page 12-4) sets the amount of time that the controller looks ahead to insert a polite ID and *Select ID Message Interval* minus *Select ID Pending Interval* sets the minimum time between IDs on an active system.

When the conversation is finished and the ID timer expires for the last time, the *Normal ID Message* is sent and the *Polite ID Macro* is executed. The identifier always has the last word. No additional identification will be sent until a new ID cycle is begun by an incoming signal.

You may program messages into the identifier by using the *Select Identifier Messages* commands on page 12-5.

- The *Initial ID Message* may contain a greeting, club name, city, CTCSS frequency, or other such information in addition to the callsign.
- The *Normal ID Message* is usually short, containing only the callsign, since it is sent occasionally throughout a conversation between user transmissions.
- The *Impolite ID Message* should be as short and inconspicuous as possible since it is sent over a user's transmission when a *Normal ID Message* cannot be inserted between users' transmissions.

The ID messages can be deleted and the ID macros used instead. For example, the *Initial ID Macro* can pulse a logic output, starting a tape cartridge machine or digital voice recorder on which the identification and greeting are recorded.

---



---

## Select Identifier Message Interval

Programs the maximum interval at which Identifier Messages occur.

- Because of the polite nature of the identifier, an ID may be earlier if there is a recent carrier drop. (*Select Identifier Pending Interval* on page 12-4.)
  - Enter the password, the 2-digit root number, the 4-digit timer number, and 1 to 5 digits from 0 to 65535 to set the *Identifier Message Interval* to 0 to 65535 seconds.
  - Set the Message Interval to zero to disable the on-demand identifier. This disables the ID for wired ports or to configure a periodic or beacon ID.
  - Transmitters in U.S. amateur service must identify at least every 10 minutes of use.
- 
- 

### Command Form:

Command	Form	Data Digit
Select Identifier Message Interval for TX1	(PW) 09 2106 xxxxx *	xxxxx = (0-65535) = (0-65535) seconds
Select Identifier Message Interval for TX2	(PW) 09 2206 xxxxx *	xxxxx = (0-65535) = (0-65535) seconds
Select Identifier Message Interval for TX3	(PW) 09 2306 xxxxx *	xxxxx = (0-65535) = (0-65535) seconds

**Acknowledgment:** Sends *OK* message

### Errors:

Error	Meaning
? err 1	wrong number of digits entered
? err 2	illegal digit entered

**Default Condition:** Identifier Message Interval is 180 seconds (3.0 minutes)

### Examples:

To change the Identifier Message Interval for Transmitter 2 to 4.5 minutes (270 seconds), enter the following command:

```
(PW) 09 2206 270 *
```

To change the Identifier Message Interval for Transmitter 1 to 9.5 minutes (570 seconds), enter the following command:

```
(PW) 09 2106 570 *
```

---

---



---

## Select Identifier Pending Interval

Programs the amount of time the controller looks ahead to send a polite ID.

- The *Identifier Pending Interval* is the amount of time before the end of the *Identifier Message Interval* (see page 12-3) that the controller looks for the transmitter's carrier to drop to insert a polite ID.
  - A longer interval allows more time for a polite ID to occur, but can cause an ID to occur more often than required.
  - Enter the password, the 2-digit root number, the 4-digit timer number, and 1 to 5 digits from 0 to 65535 to set the *ID Pending Interval* to 0 to 65535 seconds.
- 
- 

### Command Form:

Command	Form	Data Digits
Select Identifier Pending Interval for Tx1	(PW) 09 2107 xxxxx *	xxxxx = (0-65535) = (0-65535) seconds
Select Identifier Pending Interval for Tx2	(PW) 09 2207 xxxxx *	xxxxx = (0-65535) = (0-65535) seconds
Select Identifier Pending Interval for Tx3	(PW) 09 2307 xxxxx *	xxxxx = (0-65535) = (0-65535) seconds

**Acknowledgment:** Sends OK message

### Errors:

Error	Meaning
? err 1	wrong number of digits entered
? err 2	illegal digit entered

**Default Condition:** The Identifier Pending Interval is 30 seconds.

### Example:

To select an Identifier Pending Interval for Transmitter 3 of 2 minutes (120 seconds), enter the following:

```
(PW) 09 2307 120 *
```



---



---

## Select/Review Identifier Messages

Define the Initial ID, Normal ID, and Impolite ID Messages for each transmitter.

- To change a message: enter the password, the 2-digit root number and 4-digit message number shown, followed by the desired message.
  - Any message may be a combination of message types including CW, beeps, page tones, speech, etc.
  - The maximum size of any message is 50 bytes (50 2-digit codes). You must count the control characters. Therefore, any message could have 46 CW characters, 23 synthesized speech words, etc.
  - To delete a message, enter the password, the 4-digit root number, and the (\*); do not enter any message.
  - If an *Initial ID Message* is not programmed, the *Normal ID Message* is sent.
  - If an *Impolite ID Message* is not programmed, the *Normal ID Message* is sent.
  - If the *Initial*, *Normal*, and *Impolite* messages for a transmitter are all deleted, the Identifier is disabled for that transmitter.
- 
- 

### Command Form:

Command	Form	Default
Select Initial ID Message for TX1	(PW) 31 0109 (message) *	ID in CW, 587 Hz
Select Normal ID Message for TX1	(PW) 31 0110 (message) *	ID in CW, 587 Hz
Select Impolite ID Message for TX1	(PW) 31 0111 (message) *	none
Select Initial ID Message for TX2	(PW) 31 0209 (message) *	ID in CW, 698 Hz
Select Normal ID Message for TX2	(PW) 31 0210 (message) *	ID in CW, 698 Hz
Select Impolite ID Message for TX2	(PW) 31 0211 (message) *	none
Select Initial ID Message for TX3	(PW) 31 0309 (message) *	ID in CW, 1046 Hz
Select Normal ID Message for TX3	(PW) 31 0310 (message) *	ID in CW, 1046 Hz
Select Impolite ID Message for TX3	(PW) 31 0311 (message) *	none
Review Initial ID Message for TX1	(PW) 34 0109*	none
Review Normal ID Message for TX1	(PW) 34 0110 *	none
Review Impolite ID Message for TX1	(PW) 34 0111 *	none
Review Initial ID Message for TX2	(PW) 34 0209 *	none
Review Normal ID Message for TX2	(PW) 34 0210 *	none
Review Impolite ID Message for TX2	(PW) 34 0211 *	none
Review Initial ID Message for TX3	(PW) 34 0309 *	none
Review Normal ID Message for TX3	(PW) 34 0310 *	none
Review Impolite ID Message for TX3	(PW) 34 0311 *	none

---

**Acknowledgment:** Sends *OK* message

**Errors:**

Error	Meaning
? err 1	wrong number of digits entered
? err 2	illegal digit entered

**Default Condition:** See table above.

---



---

## Select Identifier-Triggered Macros

Assigns macros to be triggered at the appropriate Identifier events.

- Enter the password, the 2-digit root number, the 4-digit event-triggered macro number, and the 4-digit macro name desired. Use leading zeros if needed.
  - If you wish to unassign a previously assigned macro, enter just the password, the 2-digit root number, the 4-digit event-triggered macro number, and the (\*).
- 
- 

### Command Form:

Command	Form
Select Initial ID Macro for TX1	(PW) 26 0108 (macro name) *
Select Polite ID Macro for TX1	(PW) 26 0109 (macro name) *
Select Impolite ID Macro for TX1	(PW) 26 0110 (macro name) *
Select Initial ID Macro for TX2	(PW) 26 0208 (macro name) *
Select Polite ID Macro for TX2	(PW) 26 0209 (macro name) *
Select Impolite ID Macro for TX2	(PW) 26 0210 (macro name) *
Select Initial ID Macro for TX3	(PW) 26 0308 (macro name) *
Select Polite ID Macro for TX3	(PW) 26 0309 (macro name) *
Select Impolite ID Macro for TX3	(PW) 26 0310 (macro name) *

**Acknowledgment:** Sends *OK* message

### Errors:

Error	Meaning
? err 1	wrong number of digits entered
? err 2	illegal digit entered

**Default Condition:** No ID-Triggered Macros are assigned

### Examples:

An *ID-Triggered Macro* is useful when some device is to be energized at ID time instead of the controller's internal message generation. For example, macro 1234 can be created to pulse a logic output. This output can be wired to the start line of a tape cartridge machine. The macro name is programmed into the Initial ID Macro for TX1, so that the taped message is played only on initial identifications. The command is:

```
(PW) 26 0108 1234 *
```

---



---

## Send Initial ID Message

Forces the identifier to send the Initial ID Message, along with any ID Tail Message that may be selected, and executes the Initial ID Macro.

- Resets the *ID Timer*, sends the *Initial ID Message* and any *ID Tail Message*. It also executes the *Initial ID Macro*.
- Enter the password, the 2-digit root number, the 4-digit timer number, and the digit %*t*.

---



---

### Command Form:

Command	Form
Send Initial ID Message for TX1	(PW) 63 0114 1 *
Send Initial ID Message for TX2	(PW) 63 0214 1 *
Send Initial ID Message for TX3	(PW) 63 0314 1 *

**Acknowledgment:** Sends *ID* message

### Errors:

Error	Meaning
? err 1	wrong number of digits entered

**Default:** None

---



---

## Send Normal ID Message

Forces the identifier to send the Normal ID Message, along with any ID Tail Message that may be selected, and executes the Polite ID Macro.

- Resets the *ID Timer*, sends the *Normal ID Message* and any *ID Tail Message*. It also executes the *Polite ID Macro*.
- Enter the password, the 2-digit root number, the 4-digit timer number, and the digit %*t*.

---



---

### Command Form:

Command	Form
Send Normal ID Message for TX1	(PW) 63 0115 1 *
Send Normal ID Message for TX2	(PW) 63 0215 1 *
Send Normal ID Message for TX3	(PW) 63 0315 1 *

**Acknowledgment:** Sends *ID* message

### Errors:

Error	Meaning
? err 1	wrong number of digits entered

**Default:** None

---



---

## Select Initial and Normal ID Tail Messages

Defines the Initial and Normal ID Tail Messages.

- *Tail Messages* are programmable messages that can be appended to an Identifier Message.
  - *User Messages* are used to define *Tail Messages*. This command accepts a message number of the *User Message* to be associated with an ID. (See *Select User Messages* command on page 6-63.)
  - Enter the command with no *Tail Number* to disable the *Tail Message*.
- 
- 

### Command Form:

Command	Form
Select Initial ID Tail Message for TX1	(PW) 50 00 xxxx *
Select Normal ID Tail Message for TX1	(PW) 50 01 xxxx *
Select Initial ID Tail Message for TX2	(PW) 50 02 xxxx *
Select Normal ID Tail Message for TX2	(PW) 50 03 xxxx *
Select Initial ID Tail Message for TX3	(PW) 50 04 xxxx *
Select Normal ID Tail Message for TX3	(PW) 50 05 xxxx *

**Acknowledgment:** Sends *OK* message

### Errors:

Error	Meaning
? err 1	wrong number of digits entered
? err 2	illegal digit entered

**Default Condition:** Both Initial and Normal ID Tail Messages default to none.

### Example:

To select User Message #1 (message number 0015) as an Initial ID Tail Message for TX1, enter the command:

```
(PW) 50 00 0015 *
```

**Example: “Periodic” or “Beacon” ID**

This example describes how to set up a Periodic or Beacon ID. This ID runs at a fixed interval independent of user activity. The example can be customized to send the ID message on any combination of the three transmitter ports.

One macro is required. The macro starts or restarts a user timer and speaks the Initial ID Message. For this example, we will create macro 2010 and use User Timer #8 to generate a periodic ID interval of 15 minutes (900 seconds).

First, disable the on-demand identifier.

```
(PW) 09 2106 0 *           ; Disable TX1 On-Demand ID
; (PW) 09 2206 0 *         ; Disable TX2 On-Demand ID
; (PW) 09 2306 0 *         ; Disable TX3 On-Demand ID
```

Set up the Initial ID Message that will be sent as the beacon ID message.

```
(PW) 31 0109 <your message> ; Set the Initial ID for TX #1
; (PW) 31 0209 <your message> ; Set the Initial ID for TX #2
; (PW) 31 0309 <your message> ; Set the Initial ID for TX #3
```

Only one timer is required for all ports that ID on the same interval. Set up multiple timers if you need multiple intervals. Setup the timer and assign the macro.

```
(PW) 49 08 03 9000 *       ; Set User Timer 900.0 seconds
(PW) 49 08 02 2010 *       ; Set User Timer Macro
```

Create the macro that is executed to start or restart the sequence. This macro starts the timer and sends the Initial ID Message.

```
(PW) 20 2010 (PW) 49 08 01 * ; Start User Timer
(PW) 29 2010 (PW) 63 0114 1 * ; Send Initial ID Message for TX #1
; (PW) 29 2010 (PW) 63 0214 1 * ; Send Initial ID Message for TX #2
; (PW) 29 2010 (PW) 63 0314 1 * ; Send Initial ID Message for TX #3
```

Set the macro to execute after a power failure to automatically start the sequence.

```
(PW) 26 0000 2010 *
```

**Notes**



## Chapter 13

# CTCSS Encoders

---

The 7330 has three built-in CTCSS encoders, one for each transmitter. These encoders are very flexible and operate independently of each other. You can select the tone frequency, the mode of operation, the timing, and the type of end-of-transmission phase reversal for each encoder using the commands in this chapter.

A push-on jumper allows you to select whether the internal CTCSS tone generator or an external tone generator (via the CTCSS logic output) is driven by the CTCSS output pin on the radio port connector. The CTCSS logic outputs are separate from the 7330's eight general-purpose logic outputs.

If you configure a CTCSS radio port output pin as a logic output and interface it properly to an external encoder, you can use the *Control CTCSS Encoder* command to control the external encoder with the same modes as would be used with the internal encoder. The external encoder that you are controlling can be a CTCSS encoder or a DCS encoder.

If you don't need a CTCSS encoder for a given transmitter, you can use the CTCSS logic output pin to control other circuitry (see *Select Logic Outputs* command, page 15-3).

---



---

## Control CTCSS Encoder

### Selects the CTCSS Encoder operating mode

- Use the push-on jumper to connect either the internal CTCSS tone generator or the CTCSS logic output to pin 8 of the radio port connector (see *Installation* chapter for details). All six modes described below control the enable of either the internal tone encoder or an external tone encoder via the logic output.
- In Mode 3, the encoder turns ON at PTT key-up and stays ON for an adjustable amount of time. It turns OFF when the timer expires.
- In Mode 4, the encoder turns ON when any path keys the transmitter and stays ON as long as the path is active. When all paths go inactive, the timer keeps the encoder ON until it expires.
- Program the Mode 3 and Mode 4 timers with the *Select CTCSS ON Time* command on page 13-7.
- Reverse Burst can be enabled in one of two phase shift angles, or disabled. A reverse burst signal can help to eliminate squelch noise when the repeater or link transmitter unkeys by causing the receiver to squelch more quickly due to the sudden change in phase. The reverse burst time period is usually short (see the *Select CTCSS Reverse Burst Time* command on page 13-8).

---



---

### Command Form:

Command	Form	Data Digit
Control CTCSS Encoder	(PW) 02 w x y *	w = transmitter (1-3) x = Mode, see table y = Reverse Burst, see table

### Modes:

Mode	Meaning
0	OFF
1	Follows transmitter PTT, but turns OFF before the Minimum Unkey Delay period
2	Follows transmitter PTT
3	Turns ON when transmitter PTT is keyed and OFF at the end of the CTCSS ON Time (ON time is programmable)
4	Turns ON when Any Path is Active to a selected transmitter, then a timer starts when All Paths are Inactive to that transmitter. When the timer expires the encoder is turned OFF (ON time is programmable).
5	Always ON

**Reverse Burst Options:**

Mode	Meaning
0	OFF
1	120-degree Reverse Burst
2	180-degree Reverse Burst

**Acknowledgment:** Sends *OK* message

**Errors:**

Error	Meaning
? err 1	wrong number of digits entered
? err 2	illegal digit entered

**Default Condition:** CTCSS encoder is OFF (disabled, Mode 0).

**Example 1:** Use Mode 1 to eliminate the annoying end-of-transmission squelch burst.

Mode 1 is similar to Mode 2 but the CTCSS encode tone is turned off shortly before the transmitter PTT unkeys, at the beginning of the *Transmitter Minimum Unkey Delay* (see Figure 2 on page 11-3). This gives the user's CTCSS decoder time to close the user's squelch before the repeater transmitter unkeys, preventing a brief noise crash. The technique is sometimes called "chicken burst" because it's simpler to implement than the phase-reversal "reverse burst"; however, the 7330 supports both methods.

To turn off the CTCSS encoder at the beginning of the *Transmitter Minimum Unkey Delay* on transmitter #2, enter:

```
(PW) 02 2 1 0 *
```

Remember to set the *Transmitter Minimum Unkey Delay* time (see page 11-10). You may want to experiment with different unkey delay values and see which best minimizes the annoying squelch burst signals.

**Example 2:** Use Mode 2 to encode at the same time as PTT.

The CTCSS encode signal is used to open and close the squelch on receivers listening to the transmitter.

In this example, we'll program the transmitter #2 CTCSS encoder to be ON whenever the transmitter #2 PTT is active. Enter:

```
(PW) 02 2 2 0 *
```

If your users' radios support reverse burst, you can enable 120-degree reverse burst by changing the command to this:

```
(PW) 02 2 2 1 *
```

**Example 3:** Allow brief monitoring of QSOs in progress.

Mode 3, the Timed ON mode, can be used if stations wish to monitor just the beginnings of QSOs to find out who's on the air and not the rest of the conversation. To put the CTCSS encoder for transmitter #1 into timed ON mode for the length of the CTCSS ON Time, enter the following:

```
(PW) 02 1 3 0 *
```

The monitoring stations would set their CTCSS decoders to the same tone frequency as generated by the controller CTCSS encoder.

**Example 4:** Encode on COR.

When a port is used as a link (sometimes to an IRLP node), it's common to turn off the CTCSS as soon as all paths to that transmitter are inactive. This prevents the Courtesy Beep, the Identifier Message, and any other messages from being heard over the link. This is also sometimes referred to as "CTCSS follows COR". Mode 4 is used for this case because the encoder follows path activity. The CTCSS ON Time is set to 0.

To turn off the CTCSS when all paths are inactive to transmitter #3, enter:

```
(PW) 02 3 4 0 *
```

Remember also to set the *CTCSS ON Time* to zero:

```
(PW) 09 0315 0 *
```

**Example 5:** Variation of example 4 to include a portion of the transmitter tail.

Some users like to hear the first half second of the tail where the Courtesy Beep is normally heard. To program the CTCSS encoder for transmitter #1 into this mode and use a 180 degree reverse burst, enter the following:

```
(PW) 02 1 4 2*
```

Remember also to set the *CTCSS ON Time* for a half second (0.50 second):

```
(PW) 09 0315 50 *
```

You may want to experiment with different CTCSS ON Time values and see which best minimizes the annoying squelch burst signals.

**Example 6:** Macro control of CTCSS encoder.

You can have complete time control of the CTCSS encoders by using macros to turn them ON and OFF (Mode 5 turns the CTCSS encoder ON and Mode 0 turns it OFF).

For example, to turn the transmitter #3 CTCSS encoder ON, enter:

```
(PW) 02 3 5 0 *
```

To turn the transmitter #3 CTCSS encoder OFF, enter:

```
(PW) 02 3 0 0 *
```

---



---

## Select Frequency of CTCSS Encoder

### Selects the tone frequency of the built-in CTCSS encoder

- Use this command to set the frequency of the CTCSS encoder for a particular transmitter.
  - Enter “1”, “2”, or “3” to specify the transmitter number.
  - In the *CTCSS Tone Numbers Table* which follows, the decimal numbers 0–63 represent the 64 possible tone frequencies. Enter a 1- or 2-digit tone number to select the frequency.
  - Use the *Control CTCSS Encoder* command to choose the mode of operation of the encoder.
- 
- 

#### Command Form:

Command	Form	Data Digit
Select Frequency of CTCSS Encoder	(PW) 03 x yy *	x = transmitter = (1-3) yy = tone number (see CTCSS Tone Numbers Table)

**Acknowledgment:** Sends *OK* message

#### Errors:

Error	Meaning
? err 1	wrong number of digits entered
? err 2	illegal digit entered

**Default:** 100 Hz

CTCSS Tone Numbers					
Tone #	Freq Hz	EIA Code	Tone #	Freq Hz	EIA Code
0	33.0	*	32	123.0	3Z
1	35.4	*	33	127.3	3A
2	36.6	*	34	131.8	3B
3	37.9	*	35	136.5	4Z
4	39.6	*	36	141.3	4A
5	44.4	*	37	146.2	4B
6	47.5	*	38	151.4	5Z
7	49.2	*	39	156.7	5A
8	51.2	*	40	159.8	*
9	53.0	*	41	162.2	5B
10	54.9	*	42	165.5	*
11	56.8	*	43	167.9	6Z
12	58.8	*	44	171.3	*
13	63.0	*	45	173.8	6A
14	67.0	XZ	46	177.3	*
15	69.4	*	47	179.9	6B
16	71.9	XA	48	183.5	*
17	74.4	WA	49	186.2	7Z
18	77.0	XB	50	189.9	*
19	79.7	SP	51	192.8	7A
20	82.5	YZ	52	196.6	*
21	85.4	YA	53	199.5	*
22	88.5	YB	54	203.5	M1
23	91.5	ZZ	55	206.5	8Z
24	94.8	ZA	56	210.7	M2
25	97.4	ZB	57	218.1	M3
26	100.0	1Z	58	225.7	M4
27	103.5	1A	59	229.1	9Z
28	107.2	1B	60	233.6	M5
29	110.9	2Z	61	241.8	M6
30	114.8	2A	62	250.3	M7
31	118.8	2B	63	254.1	0Z
			64	150.0	*

\* = not a standard code  
150.0 Hz Used by NATO Military radios

---



---

## Select CTCSS ON Time

### Programs the CTCSS Encoder ON Time

- Program the CTCSS Encode ON Time for use with one of the CTCSS Control Timed Modes.
  - Enter the the 2-digit root number, the 4-digit timer number, and the delay time.
  - For the time, enter 1-5 digits, 0 thru 65535, representing 0.00 to 655.35 seconds.
  - Entering a time of 0 will disable the timer.
- 
- 

#### Command Form:

Command	Form	Data Digit
Select CTCSS Encoder ON Time for TX1	(PW) 09 0115 xxxxx*	xxxxx = (0-65535) = (0-655.35) seconds
Select CTCSS Encoder ON Time for TX2	(PW) 09 0215 xxxxx*	xxxxx = (0-65535) = (0-655.35) seconds
Select CTCSS Encoder ON Time for TX3	(PW) 09 0315 xxxxx*	xxxxx = (0-65535) = (0-655.35) seconds

**Acknowledgment:** Sends *OK* message

#### Errors:

Error	Meaning
? err 1	wrong number of digits entered
? err 2	illegal digit entered

**Default Condition:** 1.00 second.

#### Examples:

To set the CTCSS Encode ON Time to 6.00 seconds for transmitter #1, enter the following command:

```
(PW) 09 0115 600 *
```

---



---

## Select CTCSS Reverse Burst Time

### Programs the CTCSS Reverse Burst Timer

- Programs the CTCSS Reverse Burst Timer used when Reverse Burst is enabled in the *Control CTCSS Encoder* command.
  - The timer starts at PTT drop time and holds PTT active until it expires.
  - The industry standard EIA/TIA-603 lists two formats for CTCSS Reverse Burst: The format used by Motorola is 120 degree phase shift for 180 milliseconds, while the format used by all other manufacturers as well as by aftermarket tone equipment makers is 180 degree phase shift for 150 milliseconds.
  - Enter the 2-digit root number, the 4-digit timer number and the reverse burst time.
  - Enter 1-5 digits, 0 thru 65535, representing 0.00 to 655.35 seconds.
- 
- 

#### Command Form:

Command	Form	Data Digit
Select CTCSS Reverse Burst Time for TX1	(PW) 09 0116 xxxxx*	xxxxx = (0-65535) = (0-655.35) seconds
Select CTCSS Reverse Burst Time for TX2	(PW) 09 0216 xxxxx*	xxxxx = (0-65535) = (0-655.35) seconds
Select CTCSS Reverse Burst Time for TX3	(PW) 09 0316 xxxxx*	xxxxx = (0-65535) = (0-655.35) seconds

**Acknowledgment:** Sends *OK* message

#### Errors:

Error	Meaning
? err 1	wrong number of digits entered
? err 2	illegal digit entered

**Default Condition:** 0.15 seconds

#### Examples:

To set the CTCSS Reverse Burst Time to 0.18 seconds for transmitter #2, enter the following command:

```
(PW) 09 0216 18 *
```



# Select CTCSS Encoder-Triggered Macros

**Assigns macros to be triggered when the CTCSS encoder turns ON and OFF**

- Enter the password, the 2-digit root number, the 4-digit event-triggered macro number, and the 4-digit macro name desired. Use leading zeros if needed.
- To un-assign a macro that was previously assigned, enter the command but omit the macro name.

**Command Form:**

Command	Form
Select CTCSS Encoder Inactive-to-Active Macro for TX1	(PW) 26 0111 (macro name) *
Select CTCSS Encoder Active-to-Inactive Macro for TX1	(PW) 26 0112 (macro name) *
Select CTCSS Encoder Inactive-to-Active Macro for TX2	(PW) 26 0211 (macro name) *
Select CTCSS Encoder Active-to-Inactive Macro for TX2	(PW) 26 0212 (macro name) *
Select CTCSS Encoder Inactive-to-Active Macro for TX3	(PW) 26 0311 (macro name) *
Select CTCSS Encoder Active-to-Inactive Macro for TX3	(PW) 26 0312 (macro name) *

**Acknowledgment:** Sends *OK* message

**Errors:**

Error	Meaning
? err 1	wrong number of digits entered
? err 2	illegal digit entered

**Default Condition:** No CTCSS Encoder Triggered Macros are assigned

---



---

## Enable/Disable CTCSS Encoder Controls CTCSS Logic Output

Separates the operation of the CTCSS Logic Output from the CTCSS Encoder.

- Most applications either use the CTCSS Logic Output for control of an external CTCSS Encoder or use the 7330 CTCSS Encoder wired to the radio port. A special application might want to use these CTCSS Logic Output signals separately within the controller. This command enables that ability.
- See chapter 15 for the commands to use these logic outputs.
- Enter the password, the 2-digit root number, the 4-digit software switch number, and one digit, 0 for OFF (disabled), 1 for ON (enabled).

---



---

### Command Form:

Command	Form	Data Digit
Enable/Disable CTCSS Encoder #1 Controls CTCSS Logic Output #1	(PW) 63 0117 x *	0 = OFF (disabled) 1 = ON (enabled)
Enable/Disable CTCSS Encoder #2 Controls CTCSS Logic Output #2	(PW) 63 0217 x *	0 = OFF (disabled) 1 = ON (enabled)
Enable/Disable CTCSS Encoder #3 Controls CTCSS Logic Output #3	(PW) 63 0317 x *	0 = OFF (disabled) 1 = ON (enabled)

**Acknowledgment:** Sends *OK* message

### Errors:

Error	Meaning
? err 1	wrong number of digits entered (disable only)
? err 2	illegal digit entered (disable only)

**Default Condition:** All CTCSS Logic Outputs are controlled by CTCSS Encoders (ON, enabled)

---



---

## Enable/Disable CTCSS Encoder In Anti-Kerchunker No-Hangtime Mode

Controls how the CTCSS Encoder operates during the Anti-Kerchunker Key-Up Delay.

- When enabled, the CTCSS Encoder is operating in a mode other than zero (Off), and the Anti-Kerchunker is enabled and operating in No-Hangtime Mode, CTCSS will be generated during the Key-Up Delay.
- See the Anti-Kerchunker description and commands starting on page 10-7.
- Enter the password, the 2-digit root number, the 4-digit software switch number, and one digit, 0 for OFF (disabled), 1 for ON (enabled).

---



---

### Command Form:

Command	Form	Data Digit
Enable/Disable CTCSS Encoder #1 In Anti-Kerchunker No-Hangtime Mode	(PW) 63 0120 x *	0 = OFF (disabled) 1 = ON (enabled)
Enable/Disable CTCSS Encoder #2 In Anti-Kerchunker No-Hangtime Mode	(PW) 63 0220 x *	0 = OFF (disabled) 1 = ON (enabled)
Enable/Disable CTCSS Encoder #3 In Anti-Kerchunker No-Hangtime Mode	(PW) 63 0320 x *	0 = OFF (disabled) 1 = ON (enabled)

**Acknowledgment:** Sends *OK* message

### Errors:

Error	Meaning
? err 1	wrong number of digits entered (disable only)
? err 2	illegal digit entered (disable only)

**Default Condition:** OFF, disabled

**Notes**

---

## Chapter 14

# Logic Inputs

---

The *7330 Controller* supports four uncommitted *Logic Inputs* for detecting changes in conditions from sensors at the repeater site. In addition, the three COR inputs and the three CTCSS inputs are capable of acting as logic inputs in addition to their normal duties or when they are not otherwise required as receiver inputs.

Logic inputs are scanned for a transition from the High state to the Low state, and from the Low state to the High state. When one of these transitions is detected, the appropriate macro is executed.

Logic inputs can be used for alarms or indicators of such conditions as burglary, high water, high SWR, overtemperature, and so on. The inputs may be held high with pullup resistors and must be pulled down by the input device. (See the *Installation Appendix* for details on the hardware configuration.)

Booleans can be used to test a logic input from a macro (see the *If-Then-Else* command on page 5-21). Booleans can also be used to read the current value of a logic input (see the *Readback* command on page 3-20).

---



---

## Assign Macro To Logic Input

Assigns a macro to be executed by the transition shown.

- Enter the password, the 2-digit root number, the 4-digit event-triggered macro number, and the 4-digit macro name desired. Use leading zeros if needed.
- If you wish to unassign a previously assigned macro, enter just the password, the 2-digit root number, the 4-digit event-triggered macro number, and the (\*).

---



---

### Command Form:

Command	Form
Assign Macro to Logic Input 1 Hi-to-Lo	(PW) 26 0061 (macro name) *
Assign Macro to Logic Input 1 Lo-to-Hi	(PW) 26 0062 (macro name) *
Assign Macro to Logic Input 2 Hi-to-Lo	(PW) 26 0063 (macro name) *
Assign Macro to Logic Input 2 Lo-to-Hi	(PW) 26 0064 (macro name) *
Assign Macro to Logic Input 3 Hi-to-Lo	(PW) 26 0065 (macro name) *
Assign Macro to Logic Input 3 Lo-to-Hi	(PW) 26 0066 (macro name) *
Assign Macro to Logic Input 4 Hi-to-Lo	(PW) 26 0067 (macro name) *
Assign Macro to Logic Input 4 Lo-to-Hi	(PW) 26 0068 (macro name) *
Assign Macro to COR Input 1 Hi-to-Lo	(PW) 26 0115 (macro name) *
Assign Macro to COR Input 1 Lo-to-Hi	(PW) 26 0116 (macro name) *
Assign Macro to COR Input 2 Hi-to-Lo	(PW) 26 0215 (macro name) *
Assign Macro to COR Input 2 Lo-to-Hi	(PW) 26 0216 (macro name) *
Assign Macro to COR Input 3 Hi-to-Lo	(PW) 26 0315 (macro name) *
Assign Macro to COR Input 3 Lo-to-Hi	(PW) 26 0316 (macro name) *
Assign Macro to CTCSS Input 1 Hi-to-Lo	(PW) 26 0117 (macro name) *
Assign Macro to CTCSS Input 1 Lo-to-Hi	(PW) 26 0118 (macro name) *
Assign Macro to CTCSS Input 2 Hi-to-Lo	(PW) 26 0217 (macro name) *
Assign Macro to CTCSS Input 2 Lo-to-Hi	(PW) 26 0218 (macro name) *
Assign Macro to CTCSS Input 3 Hi-to-Lo	(PW) 26 0317 (macro name) *
Assign Macro to CTCSS Input 3 Lo-to-Hi	(PW) 26 0318 (macro name) *

**Acknowledgment:** Sends OK

### Errors:

Error	Meaning
? err 1	wrong number of digits entered
? err 2	illegal digit entered

**Default Condition:** No Macros assigned

---

**Examples:**

Let's assume that *Logic Input 1* has been wired to an intrusion switch. The opened switch contacts are in series between the logic input and ground. When the switch is tripped, the logic input sees a high level. We want this transition to cause the CW pitch to change. To accomplish this, you must create a macro that changes the CW pitch to the desired value. Let's assume that a macro already exists to do this, and its name is 0050.

Now, you must enter the command to assign this macro to logic input 1's low-to-high transition. The command is:

```
(PW) 26 0062 0050 *
```

---

**Note:** This is now a *latched* condition. That is, once the switch is tripped and the CW pitch is changed, the pitch will stay at the new value until commanded back to normal. This may be desirable, since the switch could have been tripped late at night. You would need to keep the CW pitch changed until acknowledged, not changed back to normal when the switch goes back to its original state.

---

Other applications require that the condition not be latched. For example: A relay could be wired with its coil to the mains power line line at the repeater site. If it has a SPST contact available, the contact could be wired in series between a logic input and ground. When the relay is energized and the contact is closed, the repeater is operating from AC power.

When the relay is de-energized and the contact is open, the logic input is pulled high by its own internal pullup resistor indicating the repeater is operating from battery power. Optionally, a message could announce %Main power off at (time)+

The contact provides this information to the controller, which could append *BAT* in CW (or a similar message) to the repeater tail message. Users would know that they should limit transmissions when they hear the *BAT* message. When AC power is restored, the controller would automatically turn OFF the *BAT* message. Optionally, a message could announce %Main power on at (time)+

To program the above scenario requires two macros: one to program *BAT* into the dropout message, and one to program (nothing) into the dropout message.

Assume that two such macros already exist, and they are: 0700 programs *BAT* and optionally announces %Main power off at (time)+, and 0701 removes *BAT* and optionally announces %Main power on at (time)+.

To assign these macros to logic input 1, enter the following commands:

```
(PW) 26 0062 0701 * (removes message)
```

```
(PW) 26 0061 0700 * (programs message)
```



---

## Chapter 15

# Logic Outputs

---

The controller has eight *Logic Outputs* that are available for your use in operating auxiliary devices at the repeater site (the three transmitter PTT outputs are not included in the eight logic outputs). In addition, when the *CTCSS Encoder* is not being used, the *CTCSS Logic Output* to each radio port can be controlled. (See *Installation* appendix for configuration details.) These outputs can be latched ON or OFF, or can be momentarily pulsed ON or OFF. LEDs on the Front Panel are lit when the output is in the ON state and off when the output is in the OFF state.

The sense of each logic output can be configured using the *Select Logic Output Inversion* command.

When *Normal*, “ON” refers to the state of an output when it is sinking current to ground; “OFF” refers to the state of an output when it is open (floating).

When *Inverted*, “ON” refers to the state of an output when it is open (floating); “OFF” refers to the state of an output when it is sinking current to ground.

Booleans can be used to test a logic output from a macro (see the *If-Then-Else* command on page 5-21). Booleans can also be used to read the current value of a logic output (see the *Readback* command on page 3-20).

The Momentary commands behave as follows:

ON Delay: If the Logic Output is OFF when a Momentary-OFF command is entered, the output will remain OFF for the duration of the timer and then go ON when it expires.

OFF Delay: If the Logic Output is ON when a Momentary-ON command is entered, the output will remain ON for the duration of the timer and then go OFF when it expires.

ON Interval: If the Logic Output is OFF when a Momentary-ON command is entered, the output will go ON, wait for the timer to expire, then go OFF.

OFF Interval: If the Logic Output is ON when a Momentary-OFF command is entered, the output will go OFF, wait for the timer to expire, then go ON.

The Momentary timers are retriggerable, which means that entering a Momentary ON command while a Momentary-ON timer is running restarts the timer. Likewise, entering a Momentary-OFF command while a Momentary-OFF timer is running restarts the timer.

If you enter a Momentary-ON command while a Momentary-OFF timer is running, the Momentary-OFF function will stop and the Momentary-ON function will start. If you enter a Momentary-OFF command while a Momentary-ON timer is running, the Momentary-ON function will stop and the Momentary-OFF function will start.

A Momentary timer can be canceled by entering an ON or OFF command, which causes the output to latch.

To sum up, the Logic Outputs always obey the last command entered.

The *Logic Output Momentary Timer* can be set for each logic output.

---



---

## Select Logic Outputs

Controls the specified Logic Outputs.

- List the outputs to be controlled by entering one or more pairs of digits describing the outputs to be controlled.

---



---

### Command Form:

Command	Form
Select Logic Outputs Latched ON	(PW) 70 (list the outputs) *
Select Logic Outputs Latched OFF	(PW) 71 (list the outputs) *
Select Logic Outputs Momentary ON	(PW) 72 (list the outputs) *
Select Logic Outputs Momentary OFF	(PW) 73 (list the outputs) *

**Acknowledgment:** Sends OK message

### Outputs:

Command	Form
Logic Output #1	01
Logic Output #2	02
Logic Output #3	03
Logic Output #4	04
Logic Output #5	05
Logic Output #6	06
Logic Output #7	07
Logic Output #8	08
Port #1 CTCSS Logic Output	09
Port #2 CTCSS Logic Output	10
Port #3 CTCSS Logic Output	11

Note: The CTCSS Logic outputs must be specifically enabled for use, see *Installation Appendix* for details.

### Errors:

Error	Meaning
? err 2	illegal digit entered

**Default Condition:** All Logic Outputs are OFF (disabled)

**Examples:**

There are several examples for logic outputs. To turn ON logic output 1, enter:

```
(PW) 70 01 *
```

To turn ON logic output 2, enter:

```
(PW) 70 02 * (Logic output 1 is still ON.)
```

To turn OFF both logic outputs, enter:

```
(PW) 71 01 02 *
```

To momentarily turn ON logic output 1, enter:

```
(PW) 72 01 *
```

To momentarily turn ON both logic outputs, enter:

```
(PW) 72 01 02 *
```

If logic output 2 is ON, you may momentarily turn it OFF by entering:

```
(PW) 73 02 *
```

---



---

## Select Logic Output Momentary Timer

Programs the momentary time for each logic output.

- Enter the password, the 2-digit root number, the 4-digit timer number, and 1 to 5 digits from 0 to 65535 to set the momentary timer to 0 to 655.35 seconds.

---



---

### Command Form:

Command	Form	Data Digit
Select Logic Output #1 Momentary Timer	(PW) 09 0000 xxxxx *	xxxxx = (0-65535) = (0-655.35) seconds
Select Logic Output #2 Momentary Timer	(PW) 09 0001 xxxxx *	xxxxx = (0-65535) = (0-655.35) seconds
Select Logic Output #3 Momentary Timer	(PW) 09 0002 xxxxx *	xxxxx = (0-65535) = (0-655.35) seconds
Select Logic Output #4 Momentary Timer	(PW) 09 0003 xxxxx *	xxxxx = (0-65535) = (0-655.35) seconds
Select Logic Output #5 Momentary Timer	(PW) 09 0004 xxxxx *	xxxxx = (0-65535) = (0-655.35) seconds
Select Logic Output #6 Momentary Timer	(PW) 09 0005 xxxxx *	xxxxx = (0-65535) = (0-655.35) seconds
Select Logic Output #7 Momentary Timer	(PW) 09 0006 xxxxx *	xxxxx = (0-65535) = (0-655.35) seconds
Select Logic Output #8 Momentary Timer	(PW) 09 0007 xxxxx *	xxxxx = (0-65535) = (0-655.35) seconds
Select Port #1 CTCSS Logic Output Momentary Timer	(PW) 09 0008 xxxxx *	xxxxx = (0-65535) = (0-655.35) seconds
Select Port #2 CTCSS Logic Output Momentary Timer	(PW) 09 0009 xxxxx *	xxxxx = (0-65535) = (0-655.35) seconds
Select Port #3 CTCSS Logic Output Momentary Timer	(PW) 09 0010 xxxxx *	xxxxx = (0-65535) = (0-655.35) seconds

**Acknowledgment:** Sends OK message

### Errors:

Error	Meaning
? err 1	wrong number of digits entered
? err 2	illegal digit entered

**Default Condition:** Momentary Timer is 0.50 seconds

---



---

## Select Logic Output Inversion

Controls the inversion of the Logic Outputs.

- When Normal (the default), ON refers to the state of the output when it is sinking current to ground; OFF refers to the state of the output when it is open (floating).
- When Inverted, ON refers to the state of the output when it is open (floating); OFF refers to the state of the output when it is sinking current to ground.
- Enter the password, the 2-digit root number, the 4-digit software switch number, and one digit, 0 for Normal, 1 for Inverted.

---



---

### Command Form:

Command	Form	Data Digit
Logic Output #1	(PW) 63 0011 x *	0 = Normal 1 = Inverted
Logic Output #2	(PW) 63 0012 x *	0 = Normal 1 = Inverted
Logic Output #3	(PW) 63 0013 x *	0 = Normal 1 = Inverted
Logic Output #4	(PW) 63 0014 x *	0 = Normal 1 = Inverted
Logic Output #5	(PW) 63 0015 x *	0 = Normal 1 = Inverted
Logic Output #6	(PW) 63 0016 x *	0 = Normal 1 = Inverted
Logic Output #7	(PW) 63 0017 x *	0 = Normal 1 = Inverted
Logic Output #8	(PW) 63 0018 x *	0 = Normal 1 = Inverted
Port #1 CTCSS Logic Output	(PW) 63 0019 x *	0 = Normal 1 = Inverted
Port #2 CTCSS Logic Output	(PW) 63 0020 x *	0 = Normal 1 = Inverted
Port #3 CTCSS Logic Output	(PW) 63 0021 x *	0 = Normal 1 = Inverted

**Acknowledgment:** Sends OK message

**Errors:**

<b>Error</b>	<b>Meaning</b>
? err 1	wrong number of digits entered (disable only)
? err 2	illegal digit entered (disable only)

**Default Condition:** All Logic Outputs are Normal (no inversion).

**Notes:**



---

## Chapter 16

# A-to-D Converter

---

The *7330 Controller* includes three *Analog Inputs* for reading DC voltages using the built-in 3-channel 8-bit analog-to-digital converter. Each analog input channel is read several times a second.

Analog inputs can be used to monitor the voltage of a backup battery, the strength of a signal into a receiver, temperature or any other voltage within the input voltage ranges. (See the *Installation Appendix* for details on the hardware configuration.)

---

**Definition:** the term analog-to-digital converter can be abbreviated a number of different ways. We try to be consistent in the manual and use A-to-D converter. In some cases you may find ADC or A2D.

---

---

**Note:** features of the A-to-D converter are being developed and delivered in successive firmware releases. Upcoming features include the storage of minimum/maximum values, alarm thresholds, averaging, scaling, speech and console readback, and additional meter faces.

---

## Analog Input Numbering

All Analog Input commands accept an Analog Input Number. The format of the Analog Input Number is:

xx

Where:

- xx is an analog input number. There are 3 analog inputs on the 7330 numbered 01, 02, and 03.

For example, analog input number 02 has the following meaning:

- ~~%02+~~. this is the specific analog input.

## Analog Input Range Selection

Analog inputs are very handy for the monitoring of voltages by the controller. Examples include measuring the voltage of a battery, the strength of a signal into a receiver, or a temperature. Each type of signal connected to an analog input channel may have different voltage range requirements.

The 7330 controller hardware provides two jumper-selectable fixed voltage ranges for each A-to-D input channel. The corresponding software switch setting must match the jumper position in order for the input voltage to be converted properly.

The two available ranges are 0 to 5 volts and 0 to 25 volts. See the Installation chapter, page B-17, for details of setting the jumper. The command to set the software switch is described on the next page.

---



---

## Select Analog Input Range

Select the range of an analog input to match the hardware jumper setting.

- This switch setting must match the corresponding jumper setting for the controller to provide valid voltage readings.
- Enter the password, the two-digit root number, the four-digit software switch number, and one digit (0 for the 0-to-25 volt range, 1 for the 0-to-5 volt range).

---



---

### Command Form:

Command	Form	Data Digit
Select Analog Input 1 Range	(PW) 63 0041 x *	0 = 0-to-25 volts 1 = 0-to-5 volts
Select Analog Input 2 Range	(PW) 63 0042 x *	
Select Analog Input 3 Range	(PW) 63 0043 x *	

**Acknowledgment:** Sends *OK* message

### Errors:

Error	Meaning
? err 1	wrong number of digits entered
? err 2	illegal digit entered

**Default:** All inputs set to 0-to-25 volt range.

### Examples:

To set the voltage range to 0-to-25 volts for analog input 1, enter:

```
(PW) 63 0041 0 *
```

To set the voltage range to 0-to-5 volts for analog input 2, enter:

```
(PW) 63 0042 1 *
```

## Averaging, Scaling, and Meter Faces

### **Current release.**

*Averaging*: each analog input is read as a raw value and displayed without averaging.

*Scaling*: each analog input is scaled only in hardware as selected by the hardware jumper and range selection command.

*Meter Face*: only unscaled voltage readings are currently available.

### **Coming soon.**

The firmware will contain commands to configure averaging, scaling, and the meter face for each analog input.

## Reading the Values

### **Current release.**

The reading for each analog input is available on the serial console remote front panel. (See page 8-14.)

Readback of the converted analog input is available using speech or on the serial console. (See page 3-20.)

### **Coming soon.**

Readback of the converted analog input will be available on the serial console.

Minimum and maximum values will be stored, available for readback, and can be cleared using a new command.

## Alarm Thresholds

### **Current release.**

Alarm thresholds are not available in the current release.

### **Coming soon.**

Alarm thresholds will allow an analog input to be used as an additional logic input. Alarm thresholds will also support event-triggered macros on high-to-low and low-to-high transitions of each analog input.

---

## *Chapter 17*

# Software Switches

---

### Overview

*Software Switches* are one of the basic *datatypes* used within the 7330 controller.

The description of software switches has been moved to page 3-9.

**Notes:**



---

## *Chapter 18*

# Counters

---

### **Overview**

Counters are one of the basic *datatypes* used within the 7330 controller.

The description of counters has been moved to page 3-13.

**Notes:**

---

## *Chapter 19*

# Timers

---

### **Overview**

Timers are one of the basic *datatypes* used within the 7330 controller.

The description of timers has been moved to page 3-15.

**Notes:**

---

## Chapter 20

# User Timers

---

The Controller features twenty *User Timers*. These timers can be used to implement timed operations not otherwise implemented by the controller.

The *User Timers* can be set in 0.1-second increments to 6553.5 seconds (slightly over 109 minutes). When a timer times out, an event macro is executed to perform a user-defined operation.

The *User Timers* can be operated as “one-shot” timers or as “retriggerable” timers.

- *One-shot timers* are timers that are started and will time to completion. Even if the start command is executed again, the duration of the timer will be measured from the first start request:

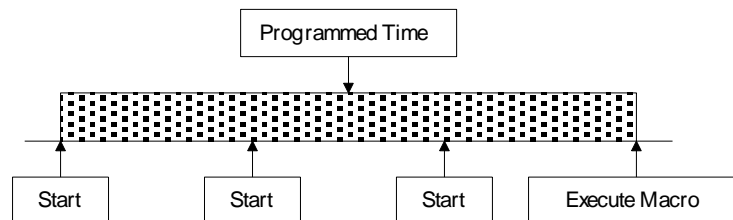

- *Retriggerable* timers are timers that are started and can be restarted during their programmed time. When retriggerable timers do time out, the time period will be the full programmed time from the last restart command:

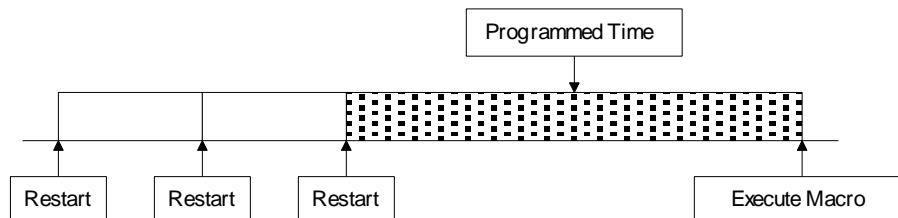

---



---

## Select Timeout Value

Programs the duration of a *User Timer*.

- The range of a one-shot or a retriggerable timer is from 0.1 second to 6553.5 seconds.
- Enter the 2-digit number to select a timer. Use a leading zero if required.
- Enter the timeout value as 1, 2, 3, 4 or 5 digits, leading zeroes are not required.
- If the timer is running when this command is executed, the timer continues to run until this new timeout value is reached. But, if the new timeout value is less than the time already expired on the timer the new timeout value is set, the timer is stopped, and the macro assigned to the timer is executed.

*Note: the maximum value was extended from 655.3 to 6553.5 in version 3.3.*

*Note: the number of timers was extended from 10 to 20 in version 3.4.*

---



---

### Command Form:

Command	Form	Data Digit
Select Timer Timeout Value	(PW) 49 (timer) 03 (delay) *	from table below

Data Digit	Explanation
Timer, 00-19	select one of 20 timers, 2 digits are required
Delay, 1-65535	Tenth-seconds in 0.1 second increments from 0.1 to 6553.5 seconds as 1, 2, 3, 4 or 5 digits

**Acknowledgment:** Sends OK

### Errors:

Error	Meaning
? err 1	wrong number of digits entered
? err 2	invalid timer or seconds parameter

**Default Condition:** 1.0 second.

### Example:

To set the timeout duration of timer 00 to 27.0 seconds, enter the command:

```
(PW) 49 00 03 270 *
```

To set the timeout duration of timer 07 to 8 minutes (480 seconds), enter the command:

```
(PW) 49 07 03 4800 *
```

---



---

## Select Timer Event Macro

Assigns the macro to be triggered when the one-shot or retriggerable timer times out.

- Enter the 2-digit timer number and 4-digit macro name to be called upon timeout of the timer. Use leading zeros if required.
- To remove the assignment to the macro, enter the command with no macro name.
- If the timer is running when this command is executed, the timer will continue to run. The last macro entered by this command will be executed at the end of the timer period.

---



---

### Command Form:

Command	Form	Data Digit
Assign Timer Event Macro	(PW) 49 (timer) 02 (macro name) *	from table below
Unassign Timer Event Macro	(PW) 49 (timer) 02 *	from table below

Data Digit	Explanation
timer, 00-19	select one of 20 timers, 2 digits are required
macro name	the name of the macro to be triggered

**Acknowledgment:** Sends OK

### Errors:

Error	Meaning
? err 1	wrong number of digits entered
? err 2	illegal digit entered

**Default Condition:** No macro assigned.

### Example:

To assign macro 9101 to timer 00, enter the command:

```
(PW) 49 00 02 9101 *
```

To assign macro 9 to timer 04, enter the command:

```
(PW) 49 04 02 0009 *
```

---

---

## Stop Timer

Stops the one-shot or retriggerable timer.

- Enter the 2-digit timer number. Use a leading zero if required.
  - If the timer is running, it is stopped without triggering the macro.
  - If the timer is stopped or has timed out, this command has no effect.
- 
- 

### Command Form:

Command	Form	Data Digit
Stop Timer	(PW) 49 (timer) 00 *	from table below

Data Digit	Explanation
timer, 00-19	select one of 20 timers, 2 digits are required

**Acknowledgment:** Sends OK

### Errors:

Error	Meaning
? err 1	wrong number of digits entered
? err 2	illegal digit entered

**Default Condition:** None.

### Example:

To stop timer 00, enter the command:

```
(PW) 49 00 00 *
```

To stop timer 09, enter the command:

```
(PW) 49 09 00 *
```



---



---

## Start Timer (Retriggerable)

Starts the selected timer as a retriggerable timer.

- Enter the 2-digit timer number. Use a leading zero if required.
  - If the timer is stopped, the timer is reset to zero time expired and started.
  - If the timer is running, the timer is reset to zero time expired and continues.
- 
- 

### Command Form:

Command	Form	Data Digit
Start/Restart Timer (Retriggerable)	(PW) 49 (timer) 01 *	from table below

Data Digit	Explanation
timer, 00-19	select one of 20 timers, 2 digits are required

**Acknowledgment:** Sends OK

### Errors:

Error	Meaning
? err 1	wrong number of digits entered
? err 2	illegal digit entered

**Default Condition:** None.

### Example:

To start retriggerable timer 00 or retrigger it, enter the command:

```
(PW) 49 00 01 *
```

To start retriggerable timer 02 or retrigger it, enter the command:

```
(PW) 49 02 01 *
```

---



---

## Start Timer (One-Shot)

Starts the selected timer as a one-shot timer.

- Enter the 2-digit timer number. Use a leading zero if required.
  - If the timer is stopped, the timer is set to zero time expired and started.
  - If the timer is running, the command is ignored.
- 
- 

### Command Form:

Command	Form	Data Digit
Start Timer (One-Shot)	(PW) 49 (timer) 04 *	from table below

Data Digit	Explanation
timer, 00-19	select one of 20 timers, 2 digits are required

**Acknowledgment:** Sends OK

### Errors:

Error	Meaning
? err 1	wrong number of digits entered
? err 2	illegal digit entered

**Default Condition:** None.

### Example:

To start one-shot timer 00, enter the command:

```
(PW) 49 00 04 *
```

To start one-shot timer 08, enter the command:

```
(PW) 49 08 04 *
```

### Example: Fan Control

Installing a fan to cool a repeater or link transmitter is always a good idea. It can extend the life of the transmitter significantly. But, leaving the fan running all the time will shorten the life of the fan.

To extend the life of the fan, the fan can be operated whenever the transmitter is keyed and for a couple of minutes after. A User Timer can be used to control the amount of time the fan stays on after the transmitter unkeys.

Three macros will be required to implement the fan control: one is triggered when the transmitter is keyed, a second is triggered when the transmitter is unkeyed, and a third is triggered when the timer times out. To control the fan, a *Logic Output* will be used to power the fan through a switching device, e.g. a relay or HexFET.

For this example, we'll create macros 8701, 8702, and 8703. We'll use timer #9 and logic output #1.

First, setup the timer and assign the macros.

```
; Setup
(PW) 49 09 03 3000 *      ; Set Timer 300.0 seconds
(PW) 49 09 02 8703 *      ; Set Timer Macro
(PW) 26 0105 8701 *       ; Set Tx1 Active Macro
(PW) 26 0107 8702 *       ; Set Tx1 Inactive Macro
```

Enter the macro that is triggered when the transmitter is keyed. This macro stops the timer and enables the logic output to activate the fan for the entire time that the transmitter is keyed.

```
; Macro: Tx1 Active: Stop Timer, Logic Out On
(PW) 20 8701 (PW) 49 09 00 * ; stop timer
(PW) 29 8701 (PW) 70 01 * ; Logic Out 1 ON
```

Enter the macro that is triggered when the transmitter is unkeyed. This macro starts the timer and leaves the fan on.

```
; Macro: Tx1 Inactive
(PW) 20 8702 (PW) 49 09 01 * ; start timer
```

Enter the macro that is triggered when the timer times out. This macro turns off the fan.

```
; Macro: Timer Timeout
(PW) 20 8703 (PW) 71 01 * ; Logic Out 1 OFF
```

**Example: An Activity Timer**

Each repeater and each receiver-to-transmitter path has an activity timer available to cause a macro to be triggered after activity on the repeater has ceased. But, sometimes one activity timer is not enough. A Retriggerable User Timer can be used to implement one or more additional activity timers.

Three macros will be required to implement the activity timer: one is triggered when the repeater is activated by a receiver, a second is triggered when all receivers are inactive, and a third is triggered when the timer times out. Our example triggers a macro that speaks a message, but any commands can be executed at that time.

For this example, we'll create macros 8711, 8712, and 8713. We'll use timer #8.

First, setup the timer and assign the macros.

```
; Setup
(PW) 49 08 03 3000 *           ; Set Timer 300.0 seconds
(PW) 49 08 02 8713 *           ; Set Timer Macro
(PW) 26 0102 8711 *            ; Set Tx1 Any-Path-Active Macro
(PW) 26 0103 8712 *            ; Set Tx1 All-Path-Inactive Macro
```

Enter the macro that is triggered when any receiver is active. This macro stops the timer.

```
; Macro: Any-Rx-Active: Stop Timer
(PW) 20 8711 (PW) 49 08 00 *   ; stop timer
```

Enter the macro that is triggered when all receivers are inactive. This macro starts the timer.

```
; Macro: All-Rx-Inactive
(PW) 20 8712 (PW) 49 08 01 *   ; start timer
```

Enter the macro that is triggered when the timer times out. This macro can perform any operation, but in our example it speaks a message.

```
; Macro: Timer Timeout, 1-second-pause + speak "Net"
(PW) 20 8713 (PW) 15 999310 9960 0307 *
```

### Example: Time-Spaced Macros

This example describes how to execute a macro, delay for some amount of time, then execute another macro. This is an example of a One-Shot User Timer. You might use this example to cycle the reset of external hardware like an AC outlet that an IRLP or EchoLink computer is plugged into by powering off the mains power outlet, waiting for a specific amount of time, then switching the mains power back on. The macro will also announce when the reset starts and when it ends.

Two macros are required to implement this example. The first macro asserts a logic output, starts a user timer, and speaks a message. The second macro deasserts a logic output and speaks another message.

For this example, we'll create macros 2010, and 2011. We'll use timer #8.

First, setup the timer and assign the macro.

```
; Setup
(PW) 49 08 03 300 *           ; Set Timer 30.0 seconds
(PW) 49 08 02 2011 *         ; Set Timer Macro
```

Create the macro that is executed to start the reset sequence. This macro starts the timer, asserts the logic output and speaks a message to ports 1 and 2.

```
; Macro: Start Sequence
(PW) 20 2010 (PW) 49 08 01 * ; Start Timer
(PW) 29 2010 (PW) 70 04*     ; Assert Logic Output
(PW) 29 2010 (PW) 15 9712 9960 0348 * ; Speak "Start"
```

Create the macro that is triggered when the timer times out. This macro can perform any operation, but in our example it deasserts the logic output and speaks another message.

```
; Macro: Timer Timeout End Sequence
(PW) 20 2011 (PW) 71 04 *    ; Deassert Logic Output
(PW) 29 2011 (PW) 15 9712 9960 0741 * ; Speak "End"
```

Notice that there's no need to stop the timer. When it times out, it will not restart without another start command.

You can use additional timers, or reprogram the same timer to sequence multiple macros spaced as you need for your application.

**Example: Timed Disable of DTMF Mute**

This example describes how to execute a macro, delay for some amount of time, then execute another macro. This is an example of a One-Shot User Timer. Using this example, a user can enter a DTMF command that will disable DTMF mute on one or more paths for a fixed period of time.

Two macros are required to implement this example. The first macro disables the DTMF mute on path RX1 to TX2, starts a user timer for 60 seconds, and speaks the message "Go ahead". The second macro enables the DTMF mute on path RX1 to TX2.

For this example we'll create macros 2010, and A032. We'll use timer #8.

First, setup the timer and assign the macro.

```
; Setup
(PW) 49 08 03 600 *           ; Set Timer 60.0 seconds
(PW) 49 08 02 A032 *         ; Set Timer Macro
```

Create the macro that is executed to start the sequence. This macro starts the timer, disables DTMF mute on a path and speaks a message to ports 1 and 2.

```
; Macro: Start Sequence
(PW) 20 2010 (PW) 49 08 01 *   ; Start Timer
(PW) 29 2010 (PW) 63 0251 0 * ; Disable DTMF mute
(PW) 29 2010 (PW) 15 9712 9960 0270 0409 * ; Speak "Go Ahead"
```

Create the macro that is triggered when the timer times out. This macro can perform any operation, but in our example it enables the DTMF mute.

```
; Macro: Timer Timeout End Sequence
(PW) 20 A032 (PW) 63 0251 1* ; Enable DTMF mute
```

Notice that there's no need to stop the timer. When it times out, it will not restart without another start command.

---

## *Chapter 21*

# Clock and Calendar

---

The *Controller* features a hardware real-time clock and calendar circuit with a lithium power source. Accurate time keeping is maintained during loss of main power.

To announce the time or date, you place special codes called *Message Run-Time Variables* into messages. (See page 6-55 for more information.) The clock is also used with the scheduler to execute macros based on the calendar and time. Please see chapter 22, *Scheduler*, for more information on this powerful capability.

The clock and calendar circuit is accurate to  $\pm 1$  minute per year. For improved accuracy, commands are provided to manually or automatically adjust the clock to compensate for drift.

Leap years are automatically adjusted.

---



---

## Set Clock and Calendar

Sets the clock and calendar.

- Enter all parameters shown below each time that you set the *Clock and Calendar*. Seconds are optional.
- All parameters consist of two digits except the day-of-week, which is one digit.
- The year parameter is needed for leap year correction.
- The clock and calendar is set when you release the (\*) button.
- Seconds are automatically set to 00 if not entered.

---



---

### Command Form:

Command	Form	Data Digit
Set Clock and Calendar	(PW) 25 (year, month, day-of-month, day-of-week, hour, minute, second)*	from table below

Data Digit	Explanation
00-99	year
01-12 (January is 01)	month
01-31	day-of-month
0-6 (Sunday is 0)	day-of-week
00-23 (24-hour format)	hour
00-59	minute
00-59	second (optional)

**Acknowledgment:** Sends OK

### Errors:

Error	Meaning
? err 1	wrong number of digits entered
? err 2	illegal parameter: any lettered key; month = 00 or greater than 12; day-of-month = 0 or greater than 31; day-of-week greater than 6; hour greater than 23; minute or second greater than 59.

**Default Condition:** 00:00:00 on Sunday, January 1, 2006. Note that the clock and calendar are only initialized if not running during a *Cold Start*.



**Example:**

Let's set the clock to 6:02 PM (18:02) on Monday, October 22, 2012.

The year is 12, the month is 10, the day-of-month is 22, the day-of-week is 1, the hour is 18, and the minute is 02. The seconds default to 00 and are not specified in the example. The entire example command is:

```
(PW) 25 12 10 22 1 18 02 *
```

---



---

## Adjust Daylight Saving Time

**Forces the clock to add, or subtract, 1-hour.**

- For the United States Daylight Saving Time program, see the *Enable/Disable Automatic Daylight Saving Time Adjustment* command on page 21-9.
- This command simplifies the semi-annual job of resetting the clock for customers affected by Daylight Saving Time. Instead of resetting the entire clock and calendar, use this command to add or subtract one hour.
- Don't use the "fall back" command between midnight and 12:59 AM (00:59). Otherwise, the hour will change to 23 (11:xx PM, 23:xx), but the day won't roll back. You will gain another day at midnight.
- Don't use the "spring ahead" command between 11:00 PM (23:00) and midnight. Otherwise, the hour will change to 00, but the day won't roll forward. You will lose a day.
- If you are using the Scheduler to automatically "fall back", use the version of the "fall back" command with the inhibit. This prevents the scheduler from executing the command more than once.

---



---

### Command Form:

Command	Form	Data Digit
Adjust Daylight Saving Time	(PW) 48 x *	0 = "fall back" (subtract 1 from hours) 1 = "spring ahead" (add 1 to hours) 2 = "fall back" prevented from being executed a second time for 61 minutes.

**Acknowledgment:** Sends OK

### Errors:

Error	Meaning
? err 1	wrong number of digits entered
? err 2	illegal digit entered

**Default Condition:** None

**Example:**

To manually set the clock 1-hour ahead, enter the command:

```
(PW) 48 1 *
```

To automatically set the clock 1-hour ahead on the second Sunday of March at 2 AM (02:00) using the *Scheduler*, create a macro (9000 for this example) and a *Scheduler* setpoint (00 for this example):

```
(PW) 20 9000 MPW 48 1 *  
(PW) 28 00 9000 03 48 02 00 *
```

To manually set the clock 1-hour behind, enter the command:

```
(PW) 48 0 *
```

To automatically set the clock 1-hour behind on the first Sunday in November at 2 AM (02:00) using the *Scheduler*, create a macro (9001 for this example) and a *Scheduler* setpoint (01 for this example):

```
(PW) 20 9001 MPW 48 2 *  
(PW) 28 01 9001 11 41 02 00 *
```

---

**Note:** See Chapter 22, *Scheduler*, for more information on setting a *Scheduler* setpoint.

---

---



---

## Reset Clock Seconds

**Forces the clock to set the seconds to zero.**

- This command simplifies the periodic synchronization of the clock to a time reference, either manually or automatically.
- If the seconds of the clock are ahead of the time reference by 1 to 29 seconds, the seconds will be reset to zero.
- If the seconds of the clock are behind the time reference by 1 to 30 seconds, the seconds will be reset to zero and the minute and hour will be incremented, if required.
- Don't use this command between 11:59 PM (23:59) and 12:01 AM (00:01). Otherwise, the time will be adjusted, but the day will be wrong.

---



---

### Command Form:

Command	Form	Data Digit
Reset Clock Seconds	(PW) 48 3 *	

**Acknowledgment:** Sends OK

### Errors:

Error	Meaning
? err 1	wrong number of digits entered

**Default Condition:** None

### Example:

To manually reset the seconds of the clock, enter the command:

```
(PW) 48 3 *
```

When entering the command, press and hold the star (\*) at the end of the command. Release the star when your time reference signals its zero mark. This will zero the seconds of the clock in synchronization with your time reference.

To automatically reset the seconds of the clock from external hardware, connect the hardware to a *Logic Input*. Create a macro (9000 in this example) and assign it to a *Logic Input* (the Hi-To-Low transition of #1 in this example):

```
(PW) 20 9000 (PW) 48 3 *
(PW) 26 20 9000 *
```

---

**Note:** See Chapter 14, *Logic Inputs*, for more information on using *Logic Inputs*.

---

---



---

## Adjust Clock Seconds

### Forces the clock to add or subtract seconds.

- This command simplifies the periodic synchronization of the clock without a time reference.
- This command is usually used with the *Scheduler* to allow the controller to adjust its own time.
- Don't use this command between 11:59 PM (23:59) and 12:01 AM (00:01). Otherwise, the time will be adjusted, but the day will be wrong.
- Use the *Message Run-Time Variable* 9816, "Seconds, CW", or 9832 "Seconds, male voice" to check the amount of correction required.
- If you are using the *Scheduler* to automatically subtract seconds from the clock, use the version of the *Subtract Clock Seconds* command with the inhibit. This prevents the scheduler from executing the command more than once.

---



---

### Command Form:

Command	Form	Data Digit
Add Clock Seconds	(PW) 48 4 (seconds) *	01-30 seconds
Subtract Clock Seconds	(PW) 48 5 (seconds)	01-30 seconds
Subtract Clock Seconds, Inhibited For 2 Minutes	(PW) 48 6 (seconds)	01-30 seconds

**Acknowledgment:** Sends OK

### Errors:

Error	Meaning
? err 1	wrong number of digits entered
? err 2	illegal digit entered

**Default Condition:** None

### Example:

Using the *Scheduler*, the accuracy of the clock over long periods of time can be improved. To know how much adjustment will be required, use the *Reset Clock Seconds* command to manually synchronize the clock to a time reference. A week later, enter the command to speak the seconds, for example:

```
(PW) 15 9832 *
```

When entering the command, press and hold the star (\*) at the end of the command. Release the star when your time reference signals its zero mark. This will cause the controller to speak the seconds reading on the clock at that time.

Note the amount that the clock is off from the reference. This is the amount of drift in the clock over a week. Take these readings each week at approximately the same time to understand the amount of drift.

Since the adjustment commands will only adjust the clock up to 29 seconds ahead or 30 seconds behind, you will need to set a *Scheduler* setpoint that occurs when the drift is less than that. Once-a-week or once-a-month may be appropriate depending on your situation.

To automatically adjust the seconds of the clock (subtract 7 seconds for this example) on the first Monday of every month at 2:00 AM (02:00) using the *Scheduler*, create a macro (9000 for this example) and a *Scheduler* setpoint (00 for this example):

```
(PW) 20 9000 MPW 48 6 07 *  
(PW) 28 00 9000 99 42 02 00 *
```

Note that the ambient temperature that the controller is subjected to may change the amount, and direction, of the clock drift. You may need to change the adjustment at different times of the year.

---

**Note:** See Chapter 22, *Scheduler*, for more information on setting a *Scheduler* setpoint.

---

---



---

## Select Automatic Daylight Saving Time Adjustment

Enable this option to automatically adjust the clock for Daylight Saving Time in the United States.

- The clock is set forward 1 hour at 2 AM (02:00) on the second Sunday in March.
- The clock is set back 1 hour at 2 AM (02:00) on the first Sunday in November.
- For other Daylight Saving Time adjustment dates, see the *Adjust Daylight Saving Time* command on page 21-4 and the example on page 21-5.
- Enter the password, the 2-digit root number, the 4-digit software switch number, and one digit, 0 for OFF (disabled), 1 for ON (enabled).

---



---

### Command Form:

Command	Form	Data Digit
Enable/Disable Automatic Daylight Saving Time Adjustment	(PW) 63 0002 x *	0 = OFF (disabled) 1 = ON (enabled)

**Acknowledgment:** None

### Errors:

Error	Meaning
? err 1	wrong number of digits entered (disable only)
? err 2	illegal digit entered (disable only)

**Default Condition:** OFF (disabled).

**Notes:**



---

## Chapter 22

# Scheduler

---

The *7330 Controller* features a powerful *Scheduler* program which accepts up to 100 time/date *Setpoints*. Each setpoint can be programmed to execute a macro based on the month, day-of-month, day-of-week, hour, and minute of the real-time clock and calendar, eg. midnight, December 31st. *Wildcards* can be used to program recurring setpoints, eg. 9:00 AM (09:00) on the first Saturday of each month.

The setpoints are compared to the real-time clock/calendar at the start of each new minute. If a match is found, the setpoint's accompanying *Macro* command is executed.

Setpoints may be individually enabled and disabled.

Since the real-time clock has a lithium power source, time-keeping is not affected by loss of main power.

Leap years are automatically adjusted by the Clock and Calendar (see chapter 21).

---



---

## Enable/Disable Scheduler

Allows the Scheduler to process scheduled events (setpoints).

- Enter this command to control if the Scheduler is allowed to process the programmed scheduled events (setpoints).
- Enter one digit, 0 for OFF (disabled), 1 for ON (enabled).

---



---

### Command Form:

Command	Form	Data Digits
Enable/Disable Scheduler	(PW) 63 0001 x *	0 = OFF (disabled) 1 = ON (enabled)

**Acknowledgment:** Sends OK

### Errors:

Error	Meaning
? err 1	wrong number of digits entered
? err 2	illegal digit entered

**Default Condition:** Enabled.

### Example:

To disable the scheduler, enter the following:

```
(PW) 63 0001 0 *
```

To enable the scheduler, enter the following:

```
(PW) 63 0001 1 *
```

---



---

## Create a Setpoint

Loads a setpoint into the Scheduler program.

- You must enter all parameters required by this command. You may force the scheduler to ignore the month, day, hour, or minute by entering the *wildcard* code, 99, for that particular parameter.
  - The Scheduler supports 100 setpoints numbered 00 through 99. You may create up to 10 setpoints which execute at the same minute. If more than one setpoint executes at the same minute, the setpoints will be executed with the lowest numbered setpoint first, the next higher setpoint second, and so on.
  - If the controller loses main power, time-keeping will continue, however, setpoints will not be executed, since the microprocessor will be down. Setpoints missed during the power failure will not be executed when power returns.
  - When you create a new setpoint, it is enabled by default.
  - Setpoints can be individually enabled and disabled. (See the *Enable/Disable Scheduler Setpoint* command on page 22-7.)
- 
- 

### Command Form:

Command	Form	Data Digit
Create setpoint	(PW) 28 (setpoint number, macro, month, day, hour, minute) *	from table below. (Use Day Code Table for <i>day</i> parameter.)

Data Digits	Explanation
00-99	setpoint number, 2 digits
xxxx	macro, 4 digits
01-12 or 99	month, 2 digits or <i>wildcard</i>
01-82 or 99	day, 2 digits (see Day Code Table, page 22-4.)
00-23 or 99	hour, 2 digits or <i>wildcard</i>
00-59 or 99	minute, 2 digits or <i>wildcard</i>

---

Scheduler Day Code Table			
Day Code	Explanation	Day Code	Explanation
01-31	calendar day-of-month	58	3rd Wednesday of month
32	weekdays (Mon-Fri)	59	3rd Thursday of month
33	weekends (Sat-Sun)	60	3rd Friday of month
34	Sundays	61	3rd Saturday of month
35	Mondays	62	4th Sunday of month
36	Tuesdays	63	4th Monday of month
37	Wednesdays	64	4th Tuesday of month
38	Thursdays	65	4th Wednesday of month
39	Fridays	66	4th Thursday of month
40	Saturdays	67	4th Friday of month
41	1st Sunday of month	68	4th Saturday of month
42	1st Monday of month	69	5th Sunday of month
43	1st Tuesday of month	70	5th Monday of month
44	1st Wednesday of month	71	5th Tuesday of month
45	1st Thursday of month	72	5th Wednesday of month
46	1st Friday of month	73	5th Thursday of month
47	1st Saturday of month	74	5th Friday of month
48	2nd Sunday of month	75	5th Saturday of month
49	2nd Monday of month	76	Last Sunday of month
50	2nd Tuesday of month	77	Last Monday of month
51	2nd Wednesday of month	78	Last Tuesday of month
52	2nd Thursday of month	79	Last Wednesday of month
53	2nd Friday of month	80	Last Thursday of month
54	2nd Saturday of month	81	Last Friday of month
55	3rd Sunday of month	82	Last Saturday of month
56	3rd Monday of month	99	every day ( <i>wild card</i> )
57	3rd Tuesday of month		

**Note:** Don't confuse the 99 used here as a Scheduler Day Code Wildcard with the 99 used as the default Master Password. The controller will not confuse them.

**Note:** If your Day Code is occurring on the wrong day of the week, you may need to set your clock. Set your clock being careful to specify the correct day-of-week.

**Note:** You cannot expect the N-th Monday of the month to be the day before the N-th Tuesday since it depends on when the month starts.

**Example #1, Creating Setpoints:**

To execute macro 1234 every hour, on the hour, every day, every month, enter the following:

```
(PW) 28 00 1234 99 99 99 00 * ; Setpoint 00
```

---

**Note:** The 99's in the parameters of this command are used as a wildcard for the month, day and hour. The controller will not confuse the parameters with the default Master Password.

---

To execute macro 1234 every day at 6:15 AM (06:15), every month, enter the following:

```
(PW) 28 01 1234 99 99 06 15 * ; Setpoint 01
```

To execute macro 1234 at 10:30 AM (10:30) on the weekend (Saturday and Sunday), every month, enter the following:

```
(PW) 28 02 1234 99 33 10 30 * ; Setpoint 02
```

To execute macro 1234 at midnight (00:00) every Saturday in June, enter the following:

```
(PW) 28 03 1234 06 40 00 00 * ; Setpoint 03
```

To execute macro 1234 at noon (12:00) on April 15th, enter the following:

```
(PW) 28 04 1234 04 15 12 00 * ; Setpoint 04
```

To execute macro 1234 at 5:00 PM (17:00) on the first Thursday of every month, enter the following:

```
(PW) 28 05 1234 99 45 17 00 * ; Setpoint 05
```

To execute macro 1234 at 2:00 AM (02:00) on the last Sunday of October, enter the following:

```
(PW) 28 17 1234 10 76 02 00 * ; Setpoint 17
```

It is not necessary to fill in each setpoint starting from 00. Unprogrammed setpoints that cause gaps in the sequence will be ignored by the Scheduler.

You can minimize the number of programmed setpoints with creative programming. For example, you may wish to execute a macro at 10:00 PM (22:00) each day of the week *except* Sundays. Instead of creating six setpoints for Monday through Saturday, create just two: one for Saturday, and one for weekdays.

---

**Note:** When using *wildcards*, be sure of their function. For example, if you create a setpoint where Month = 01, Day = 01, Hour = 00, and Minute = 00, the macro will execute at midnight, January 1st. If you accidentally set Month = 01, Day = 01, Hour = 99, and Minute = 99, assuming the macro will execute at the start of January 1st, the unexpected will happen: the macro will execute every minute of every hour for as long as it is January 1st (that is, from 00:00 January 1st until and including 11:59 PM (23:59) January 1st).

---

### Example #2, Play A Top-Of-The-Hour Message:

To send a message at the top of the hour from 8 AM to 8 PM (08:00 to 20:00) every day, create three macros and define three setpoints.

Here's how it works:

- Scheduler setpoints 0 and 1 define the time period during which setpoint 2 will be enabled, 7:59 AM (07:59) thru 8:01 PM (20:01). When setpoint 0 is matched, macro 4100 is executed enabling setpoint 2; when setpoint 1 is matched, macro 4101 is executed disabling setpoint 2.
- Scheduler setpoint 2 defines how often to play the message. With the wildcards (99) in the month, day, and hour parameters of the setpoint and the minute parameter set to 00, macro 4102 is executed every hour on the hour when setpoint 2 is enabled.

```
(PW) 20 4100 (PW) 28 02 1 *           ; enable setpoint 2
(PW) 20 4101 (PW) 28 02 0 *           ; disable setpoint 2
(PW) 20 4102 (PW) 15 <message contents> * ; play message

(PW) 28 00 4100 99 99 07 59 *         ; setpoint 0 at 7:59 am (07:59)
(PW) 28 01 4101 99 99 20 01 *         ; setpoint 1 at 8:01 pm (20:01)
(PW) 28 02 4102 99 99 99 00 *         ; setpoint 2 play message
                                        ; every hour on the hour
                                        ; when enabled
```

### Other Uses:

Other suggested uses for the Scheduler include:

- Enable and disable a feature based on time of day (weekends could be different from weekdays).
- Change from standard time to daylight saving time in areas not supported by the built-in U.S. daylight saving time algorithm.
- Switch on and off external hardware using a logic output.
- Change from your normal repeater mode to net mode.
- At night, change the ports that are linked together.

---



---

## Enable/Disable One or More Setpoints

Enables or disables a single setpoint or a range of setpoints for the Scheduler program.

- To enable or disable a single setpoint, enter the setpoint number and the one-digit enable/disable value.
  - To enable or disable a range of setpoints, enter the first and last setpoint number and the one-digit enable/disable value.
  - Enter the two-digit setpoint number and the one-digit enable/disable value. Use a leading zero for the setpoint number, if required.
  - When a new setpoint is created, it is enabled by default.
- 
- 

### Command Form:

Command	Form	Data Digit
Enable/Disable One Setpoint	(PW) 28 (setpoint) x *	00-99, setpoint number x = 0/1 0 = OFF (disabled) 1 = ON (enabled)
Enable/Disable Range of Setpoints	(PW) 28 (first setpoint) (last setpoint) x *	

**Acknowledgment:** Sends OK

### Errors:

Error	Meaning
? err 1	wrong number of digits entered
? err 2	illegal digit entered

**Default Condition:** Setpoints are enabled.

### Example:

To disable setpoints 4 through 26, enter the following:

```
(PW) 28 04 26 0 *
```

To enable a single setpoint, 14, enter the following:

```
(PW) 28 14 1 *
```

---



---

## Delete One or More Setpoints

Deletes a single setpoint or a range of setpoints from the Scheduler program.

- To delete a single setpoint, enter just the setpoint number.
  - To delete a range of setpoints, enter the first and last setpoint number to be deleted.
  - Enter the 2-digit setpoints 00-99. Use a leading zero, if required.
- 
- 

### Command Form:

Command	Form	Data Digit
Delete One Setpoint	(PW) 28 (setpoint) *	00-99, setpoint number
Delete Range of Setpoints	(PW) 28 (first setpoint) (last setpoint) *	00-99, setpoint number

**Acknowledgment:** Sends OK

### Errors:

Error	Meaning
? err 1	wrong number of digits entered
? err 2	illegal digit entered

**Default Condition:** No setpoints exist.

### Example:

To delete setpoints 4 through 26, enter the following:

(PW) 28 04 26 \*

To delete a single setpoint, 14, enter the following:

(PW) 28 14 \*



---

## Chapter 23

# Custom Audio Library

---

The 7330 and associated support software supports the capability for you to develop your own custom audio words and messages. These can be used in addition to what is already available in the standard Speech Vocabulary Tables. You can create and add individually playable words up to a total maximum length of 13 minutes of audio, consisting of sounds, words, phrases, and announcements. You are only limited by your imagination and by any regulatory restrictions appropriate for your use of the repeater.

Information on using both custom audio words as well as the predefined words can be found in chapter 6 in the topic *Speech Messages*. This includes information on the new controller capability to route audio to different transmitter ports. The pre-defined words already supported in the controller can be found in the *Standard Speech Vocabulary Table* found in Appendix A.

A custom library is organized into words or phrases each accessed by a unique word code. This is the same scheme as is used for the 1600+ words available in the standard vocabulary. The controller enables you to extend the existing vocabulary with up to 2000 additional customized words or phrases that you can record and add to the repeater. While for convenience we are using the term “words”, each word really represents any sound ranging from a single 1/8000 second sample up to 13 minutes of audio.

The process of generating custom audio involves generating and/or gathering separate audio files in any format that can then be converted into the  $\mu$ -law format using SoX, Audacity® or other audio format conversion software. Then, S-COM's PC-based application is run that converts the directory of audio files into a Custom Audio Library file (`CustomAudioLib.bin`). Like managing other files in the controller, the SBOOT utility is used to load or erase the Custom Audio Library file. These last steps are very similar to how a replacement standard speech library is loaded into the controller.

The bulk of this chapter describes using audio file format conversion software (SoX and Audacity® are shown) for generating S-COM controller custom audio formatted files. For recording, we describe the Audacity® software application. These are Open Source programs available for download that run on the Windows, MacOS X, and Linux operating systems. However, the SCOM utility to convert the SCOM controller-compatible audio files into a download-able custom speech library is currently only available for the PC.

## Audio File Format Conversion

There are a large number of audio file formats that have been used to store audio, though only a few are in common use. You are probably most familiar with Microsoft .WAV files. To use this audio in your controller, you will need to convert these audio files to the format required by the S-COM tools.

### File Formats and Recording Settings

The following format is required by the S-COM controller for loading and playing custom audio files:

- 8000 Hertz sampling rate
- Single channel (mono) audio
- $\mu$ -law encoding
- Raw headerless file

The  $\mu$ -law encoding algorithm is used to reduce the dynamic range of the audio signal which increases the signal to noise ratio and allows us to store more audio in the controller. More specific information can be found at:

[http://en.wikipedia.org/wiki/%CE%9C-law\\_algorithm](http://en.wikipedia.org/wiki/%CE%9C-law_algorithm)

This data encoding format is commonly supported in audio conversion tools.

The raw file format is used with many encodings of audio data and has no header, just the 8-bit audio information. More information on audio file formats is available at:

[http://en.wikipedia.org/wiki/Audio\\_file\\_format](http://en.wikipedia.org/wiki/Audio_file_format)

The controller speech algorithms are capable of taking audio recordings as a playable “word” file that can vary in length from 1 sample (1/8000 of a second) up to the maximum available storage capability (just over 13 minutes).

### Tools

There are many tools available for converting file formats. The only requirement is that it be able to produce the format defined above.

In this chapter, we describe two such tools. One, *SoX*, is a command line tool. The other, *Audacity*<sup>®</sup>, is a GUI tool. Both are available on multiple operating systems.

## Getting Started

We are going to work in a single directory on your computer. The instructions that follow will have you create a directory, collect some sample files, and get the latest copy of the S-COM utility that builds your custom audio library.

### Create a Working Directory

Start by creating a directory on your computer to store your original audio files, the converted files, and the tools needed to build your custom audio library. Our examples in this chapter will use Windows and the directory:

```
C:\SCOMFiles
```

Create this directory on your computer.

### Get the Latest S-COM Release

We included a CD with your controller that included all the firmware and utilities that were available at that time. But, it is always best to use the latest version that is available in the latest firmware release. Check for the latest firmware release at:

<http://www.scomcontrollers.com/>

Click on *Firmware Upgrades*. If there's a newer release than the one you have already installed, download it. Once downloaded, extract the files from the archive file into a temporary directory. We will be copying files from there to build your custom audio library.

## Sample Files

In the release, we have included sample files to use for demonstration. Copy these from your CD or the latest release to `C:\SCOMFiles`.

- `DemoAudioLib.bin` – this pre-built demonstration library contains the three speech words described below as word codes 4000, 4001, and 4002. You can load this file directly into the controller.
- `4000.raw` – this is a demo file that describes the 7330, 136 seconds.
- `4001.raw` – this is a swept 300 to 3000 Hz sine wave, 3 seconds.
- `4002.raw` – this is a 440 Hz sine wave, 3 seconds.

The sine wave words can be included in your custom audio library for testing your controller.

## BuildSpeechLib.exe

The S-COM utility `BuildSpeechLib.exe` is used to build your custom audio library from your converted audio files. Copy `BuildSpeechLib.exe` from your CD or the latest release to `C:\SCOMFiles`. We will use it later when we build our library.

## Filenames

Your original audio files can have any name and be in any format accepted by the audio file format converter. You will provide this name to the file converter to generate the files that the S-COM utility requires.

Converted files that are to be combined into a custom audio library are named with the word code number. You can number these files from 3000 thru 4999, the supported custom audio library word codes. These filenames must always end with `.raw`. Here some examples of acceptable filenames:

```
3000.raw
3001.raw
3192.raw
4000.raw
4999.raw
```

The custom audio library output file of the BuildSpeechLib.exe utility will always be named:

```
CustomAudioLib.bin
```

You can rename this file to be anything you want. You will select this file when load your custom audio library into the controller.

## **Taking Care of Your Files**

There are a few best practices to consider when working with custom audio library files:

1. Keep a cross-reference handy that displays word codes and the corresponding message kept at that word code.
2. Back up the folder containing the custom audio files. Later when you want to edit by adding or removing words, this backup file can be a good starting point.
3. Back up the folder containing the original audio files before they are converted into .raw files.
4. When a modification needs to be made to the existing set of words, make sure to check which macros and messages refer to the custom audio library word codes. It's easy to accidentally remove a word code from the custom audio library file and still have macros programmed into the repeater that refer to that code.

## Building a Custom Audio Library

The S-COM utility `BuildSpeechLib.exe` file takes a directory of custom audio files and builds a `CustomAudioLib.bin` file that can be downloaded to the controller. This file contains all of the custom words that you have defined in your directory, and will be used by messages defined in the controller whenever a word code in the range 3000 through 4999 is used in a speech message.

The following sample screen shot shows a collection of 20 word files stored in folder `C:\MyWords` that have been converted to `.raw` using Audacity®.

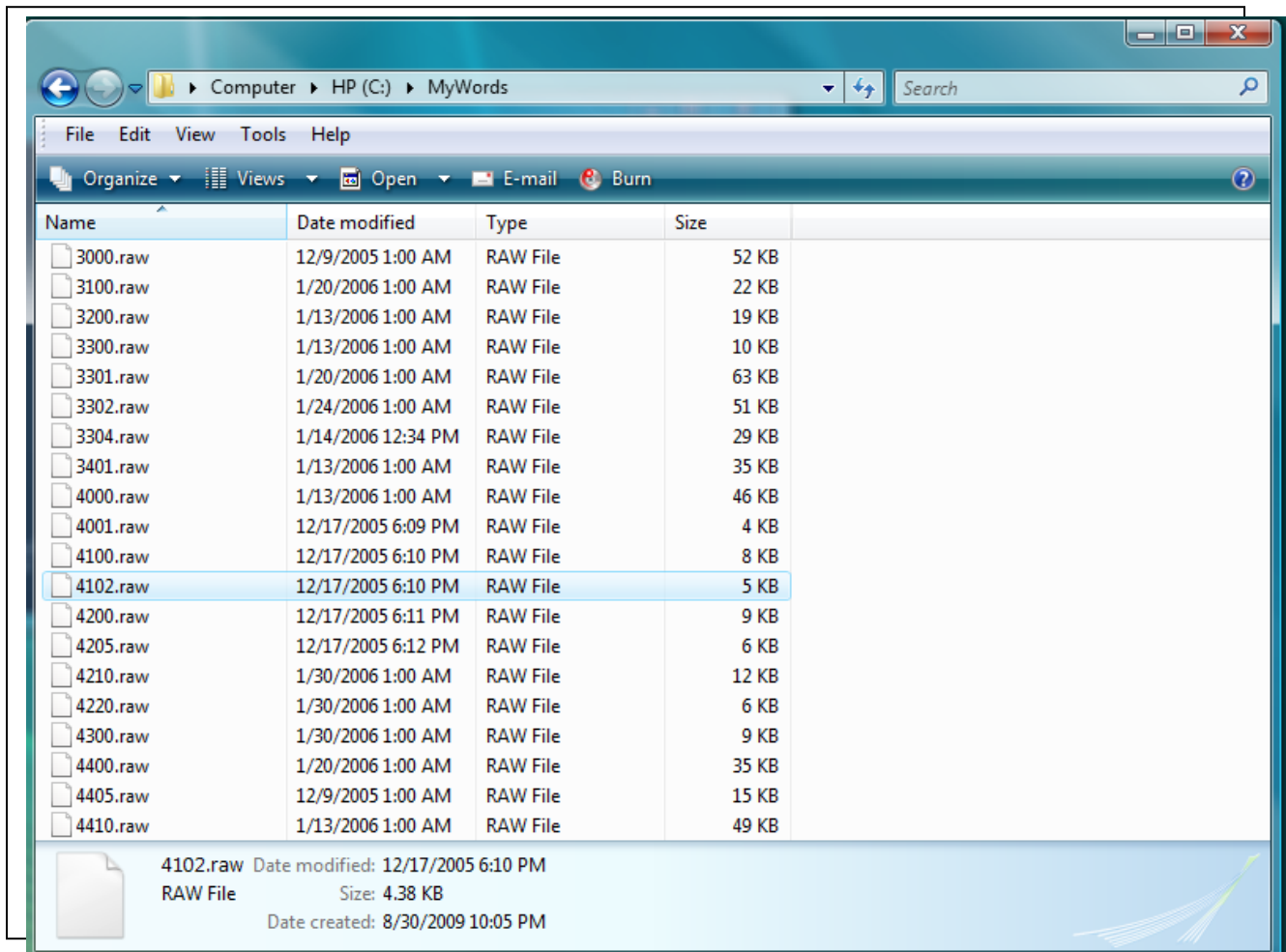

To build your custom audio library, execute `BuildSpeechLib.exe` at a Windows Command prompt in the folder containing your `.raw` files:

```
C:\SCOMFiles\BuildSpeechLib.exe <folder location of
custom audio words>
```

For example, if you have saved your custom words in the folder `C:\MyWords`, then you would type in:

```
C:\SCOMFiles\BuildSpeechLib.exe C:\MyWords
```

Or, if your raw files are in the same directory, then you would type in:

```
C:\SCOMFiles\BuildSpeechLib.exe .
```

Don't forget the period at the end of the command line!

## What the Utility Does

The utility will first check to make sure that the files are all named appropriately and that the total required recording time is less than the maximum time allowed (13 minutes). It will either output an error message or it will generate the `CustomAudioLib.bin` file in the same folder where the `BuildSpeechLib.exe` file is located.

This program takes less than 3 minutes to run to populate up to 13 minutes of custom audio files.

---

**Note:** If you don't specify a folder, the `BuildSpeechLib.exe` program will assume you have used the folder:

```
CustomAudioFiles
```

located in the same folder as `BuildSpeechLib.exe`.

---



---

## Utility Output Example, Successful

```
S-COM Build Speech Lib Utility, V1.0.0
Copyright S-COM, LLC. www.scomcontrollers.com All rights reserved,
2009

Pass 1: Create file list
Done
    Number Files referenced in input file=12

Pass 2: getImageSize from all files...Done
    Number of Bytes to Store Word Data=130116 (0x1FC44, Does not include
index and fileheader)
    Number of SpeechLib Index Entries Required=3012 (0xBC4)

Pass 3: Build headers and Speech Library file...
    Total File Size = 0x22E44
    Flash Sectors Required to Store This File = 3 (0x3)
Done

Pass 7: Verify .bin output file...
Starting Verify...
    Verify Pass: ffs_imageHeader.isz (Size of Speech Library File)
=0x22E44
    Verify Pass: ffs_imageHeader.itype=0x3
    Verify Pass: sl_header.si_oBas (Offset to Basic Word Index) =0x200
    Verify Pass: sl_header.si_nBas (Number of Basic Index Entries) =3012
(0xbc4, max was MAX_WORDCODE_INDEX)
    Verify Pass: sl_header.si_sBas (Number of Entries * 4 Rounded up to
256 Boundary) =0x3000
    Verify Pass: sl_header.si_lBas (First Free Address in Speech File)
=0x22e44
    Verify Pass: Found 12 entries pointing to samples.
    Verify Complete.
Done
```

## Utility Output Example, Cannot Find Input Files

```
S-COM Build Speech Lib Utility, V1.0.0
Copyright S-COM, LLC. www.scomcontrollers.com All rights reserved,
2009

Pass 1: Create file list

Error: no entries were found in directory: CustomAudioFiles
with the format xxxx.raw. Please correct the directory name
or verify that entries are in the directory in the range
3000.raw through 4999.raw.
```

## Loading Your Custom Audio Library into the Controller

The loading process for a Custom Audio Library is the same as the process for all other files. See the “Updating the Custom Audio Library” topic in the Firmware Update document for the latest S-COM 7330 firmware release.

## Using Your Custom Audio Library

Once you have succeeded in loading the `CustomAudioLib.bin` file into the controller, any macro or message string can now access the custom words you have created. For example, a simple command that will play the first three recorded words in the library shown in the screenshot on page 23-7 might look like the following:

```
(PW) 15 9960 3000 3100 3200*
```

For more information on creating speech messages, see Chapter 6, Messages, page 6-55, Speech Messages.

## Using SoX

SoX is an open source audio file format converter for Windows™, MAC OS X, GNU/Linux and other operating systems. It is a command line utility. It allows you to easily convert from one audio file format to another.

### Downloading SoX

Like most open source applications, SoX is available directly from SourceForge. Go to the following web page and download the executable for your operating system.

```
http://sox.sourceforge.net/
```

Documentation for SoX comes in the download as a .pdf. To read it on-line, you can visit the SoX man page:

```
http://sox.sourceforge.net/Docs/Documentation
```

### Installing SoX

As of SoX version 14.3.0, SoX for Windows is distributed in a .zip file instead of using an application installer. Extract the files to a `sox-14.3.0` directory. Be sure to read `README.win32.txt`. There are additional instructions for a Windows installation.

Copy `sox.exe` to `C:\SCOMFiles`. This makes it easy to use. Or if you're comfortable setting the `PATH` variable, leave `sox.exe` in its original location and setup the `PATH` to it.

### Converting Files Using SoX

SoX has been optimized to perform file conversion tasks. For .wav files, SoX reads the .wav file header to determine the format of the audio in the file. The output format used by the SCOM utility is specified in the following command with the `-t ul` option.

To convert a .wav file named `MessageTone.wav` to word code 3345, enter the following command:

```
sox MessageTone.wav -r 8k -t ul 3345.raw
```

## Generating Audio Test Files Using SoX

SoX has an option called `synth`. Using this option, test tones in different formats and at different levels can be generated as custom audio files to load into the controller. The sample files that are included in the release were generated using this SoX feature.

To generate a 3 second swept sine wave of 300-3000Hz as word code 4001, enter the following command:

```
sox -r 8000 -t ul -n 4001.raw synth 3 sine 300-3300
```

To generate a 3 second sine wave at 440Hz as word code 4002, enter the following command:

```
sox -r 8000 -t ul -n 4002.raw synth 3 sine 440
```

## Using Audacity®

*Audacity®* is an open source free audio editor for Windows™, MAC OS X, GNU/Linux and other operating systems. It allows you to record live audio that can then be converted into custom words, announcements, or sound effects for use with the controller. It also allows you to convert existing audio files in a variety of different formats into the format used in the controller. While preparing a file, you can perform a whole variety of different special effects on the audio including cutting/copying/mixing/ and splicing of sounds together.

## Downloading Audacity®

Audacity® is available as a download from the official Audacity® site located at:

<http://Audacity.sourceforge.net>

There is also a wealth of information available in the wiki associated with Audacity® at:

[http://wiki.Audacityteam.org/index.php?title=Audacity\\_Wiki\\_Home\\_Page](http://wiki.Audacityteam.org/index.php?title=Audacity_Wiki_Home_Page)

This manual assumes that you will be using Audacity® version 2.05 or later on a PC. The operations are similar with other operating systems and versions.

This manual only covers the basics needed to either record a new audio file or to convert audio files not already in the `.raw` format.

## Installation of Audacity® 2.0.5 and Similar Versions

The process to download and install Audacity® follows the standard protocol used by most open source programs. You navigate to the website and click the links to download and install the program. The streamlined steps are as follows.

1. Navigate to:

`http://sourceforge.net/projects/audacity/`

2. When prompted to run or save the downloaded file, save the file in a desired location on your PC. For example, you might save it at:

`C:\Downloads\Audacity-win-2.0.5.exe`

3. Run the program from where you saved it.

Click on the `Audacity.exe` program at this desired location. You may need to navigate through security settings. You will be asked to choose a language for Audacity® to use. Then you should see the application which looks like the following.

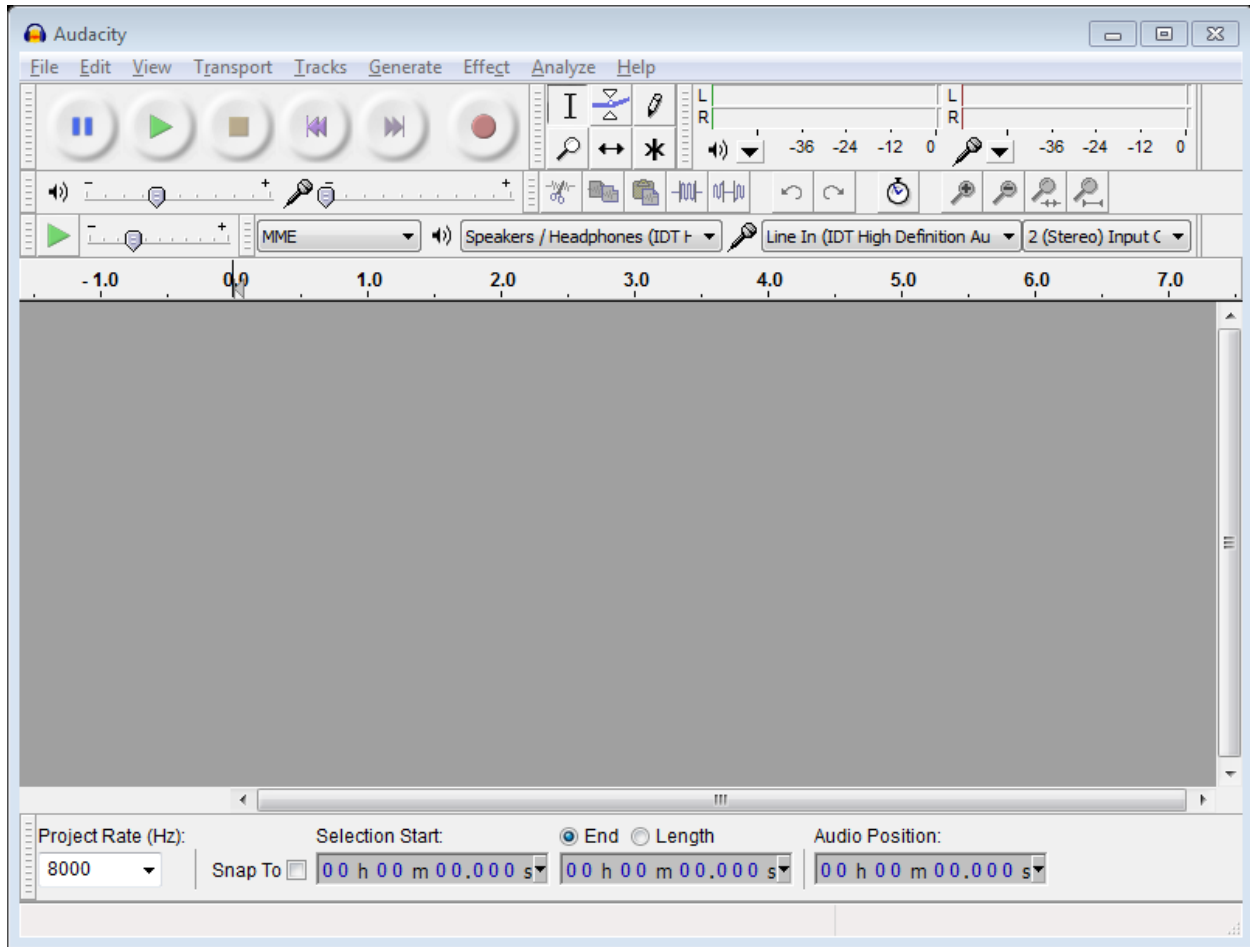

4. Now, set the project defaults for use with the controller. Go to the edit menu and click on Preferences.

Select the Quality section and set the Default Sample Rate to be “8000 Hz”, the Default Sample Format to be “16-bit”, the Real-time Conversion Sample Rate Converter to be “High-quality” and the High-quality Conversion Sample Rate Converter to be “High-quality”. These will be the best settings to use for generating and converting files for the 7330 Controller.

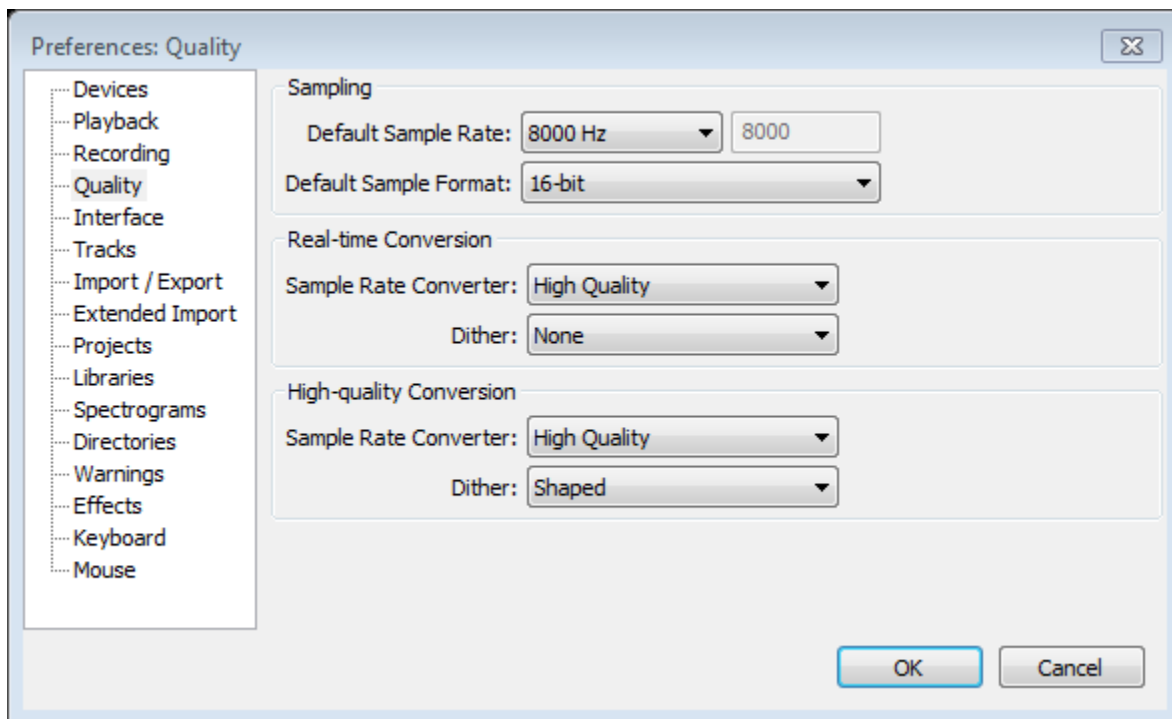

- Click on the Devices section and select the Playback and Recording devices you are using with your PC. They may differ from the ones shown in the example below. If you can play a .wav file, the Playback device is already set correctly. You only need to set the Recording device if you are recording live audio. Click on the OK button when you have made your selections.

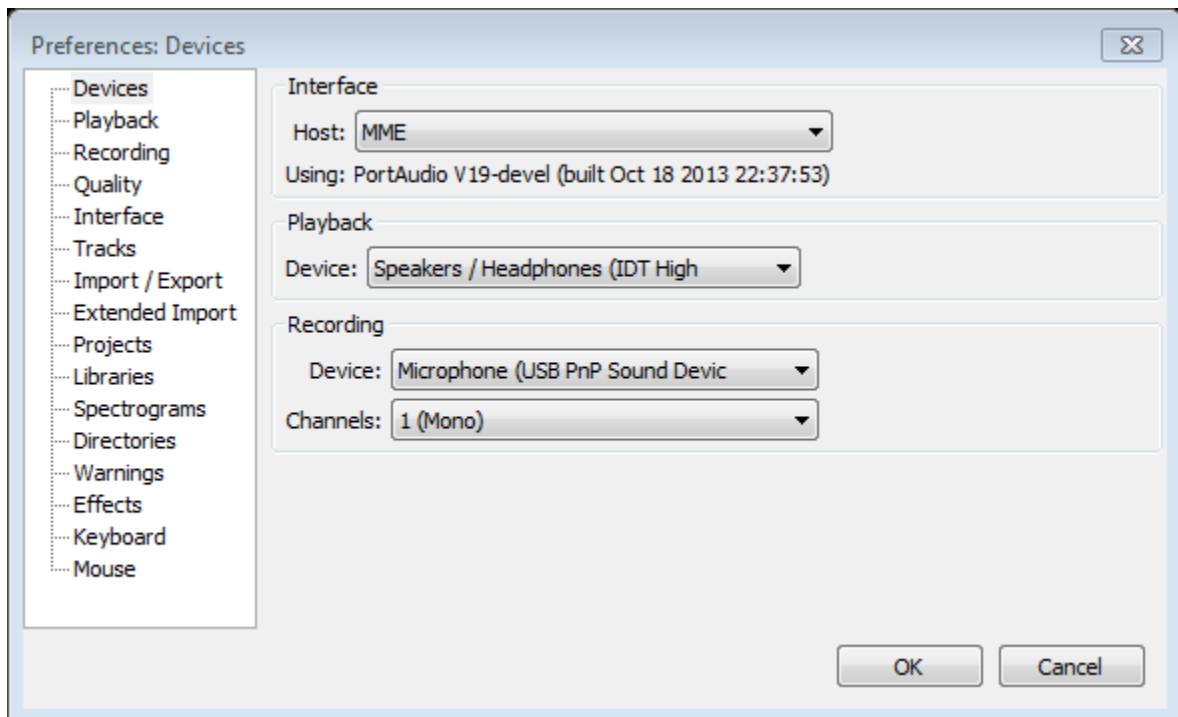

- This completes the setup of Audacity® for generating files for use with the 7330.



## Example 1: Converting an existing .wav file into an S-COM Custom Audio file

One very common task that you might want to do is to take an existing .mp3 or .wav file and convert it into a word file in SCOM custom audio format. Then, this word can later be assembled with other words into a complete custom audio library. Here are the steps to make that conversion using Audacity®:

1. Start Audacity® and click on the Project menu. Click on the Import Audio menu selection. Select the desired file to import. After importing you will see a display that looks like the following. Notice that in this case the file was imported at a project sample rate of 11025 Hz, and is in 16 bit audio (the file was initially a .wav file).
2. Change the project rate to be 8000 Hz by clicking on it and selecting 8000 Hz.

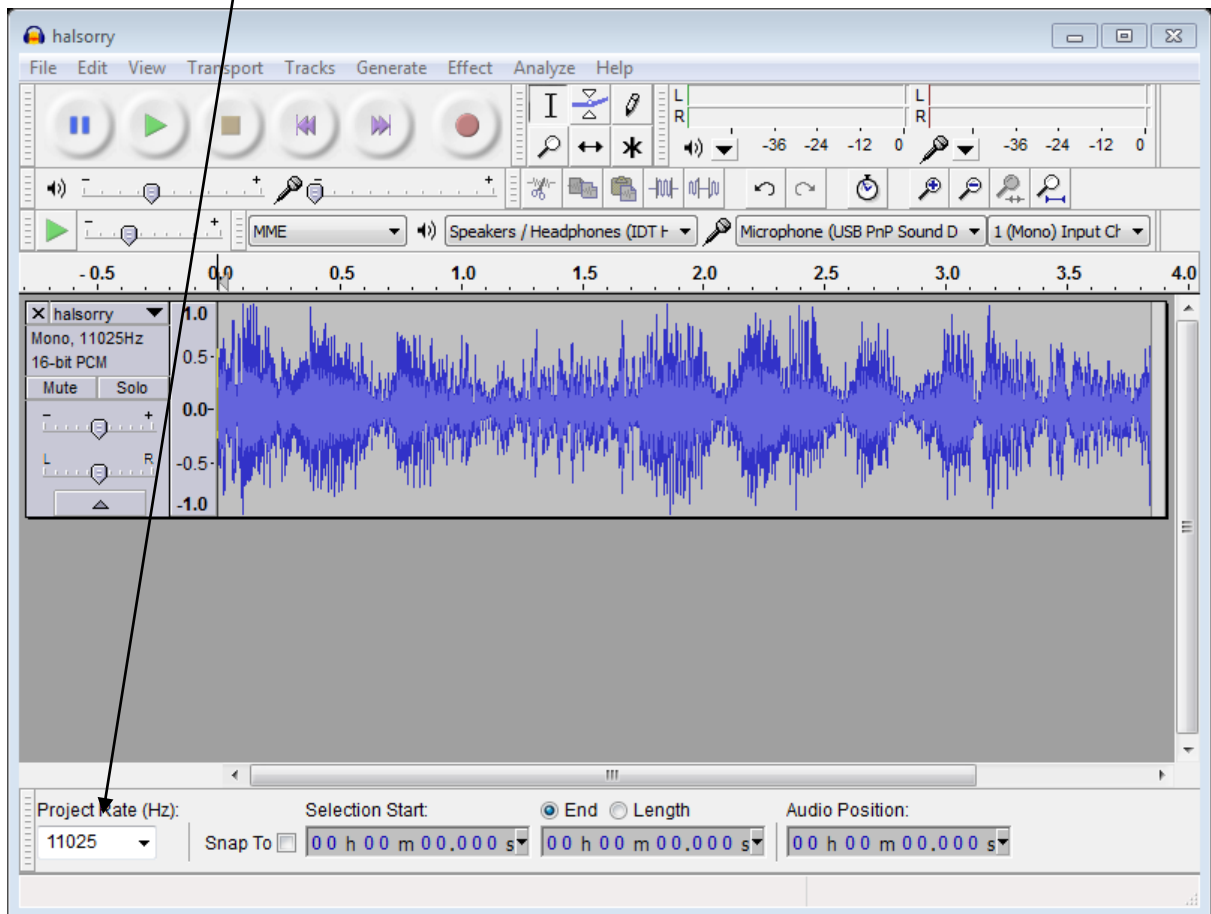

3. Select Tracks, then Resample. Enter a New sample rate of “8000”.

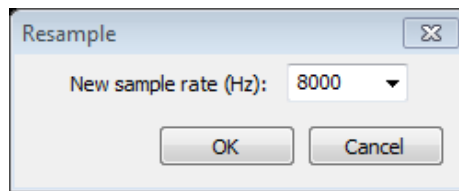

4. This step is optional. Some sound files have differing audio levels. The controller will play whatever audio levels you provide. If you are going to intermix your recordings with the built-in speech library, adjusting the audio levels of your custom records will improve the sound of the played messages.

Select Effect, then Amplify.

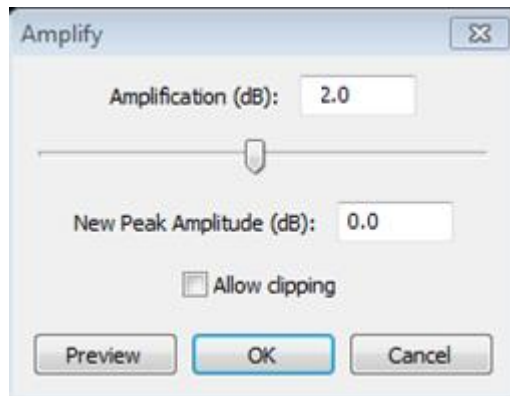

Set the New Peak Amplitude field to 2.0. Check the Allow Clipping box, then click OK. The result will be adjusted audio that has levels similar to the built-in speech library. In some cases, you will have to increase the audio even more.

5. Select File, then Export. In the Save As Type field, select “Other uncompressed files”.
6. Select Options to display the Set Uncompressed Options Dialog. Set the Header field to “RAW (header-less)”. Set the Encoding field to “U-Law”. Click OK.

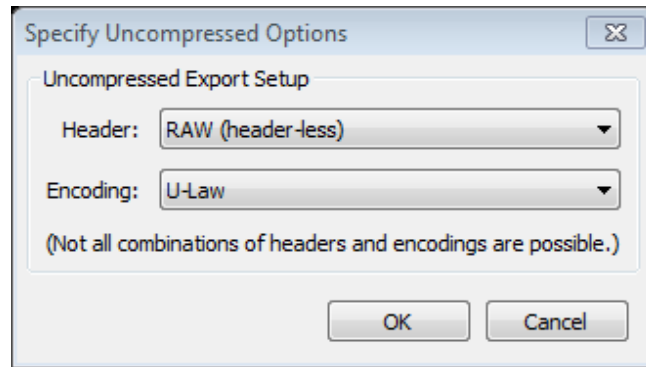

- 6.7. Select as a unique filename a word number between 3000 and 4999. Save the file (in this example, it is saved as 3022.raw). Note that this will be the word code you will use to refer to this audio recording later when defining a speech message. In the Edit Metadata dialog, just click OK.

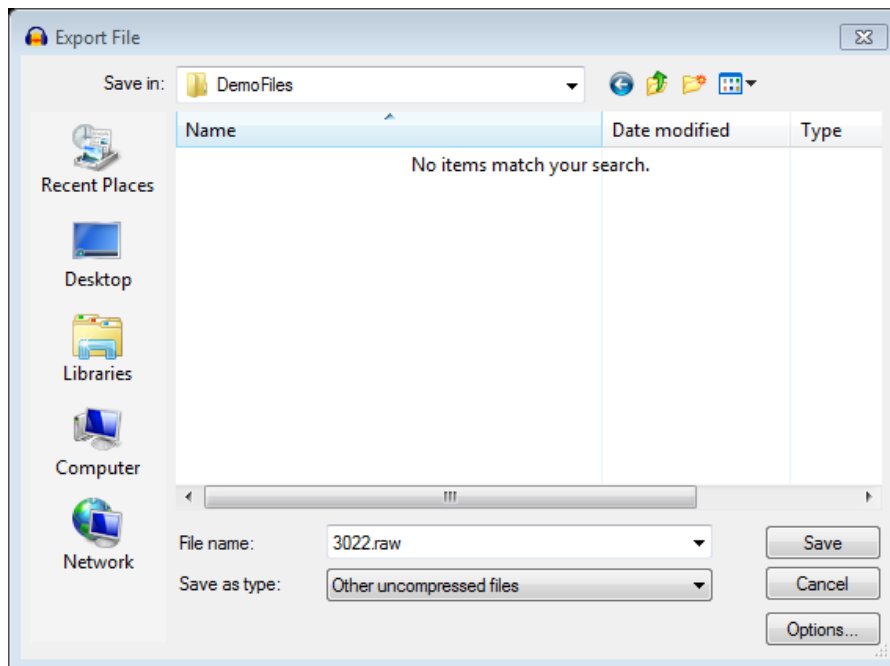

- 7.8. Repeat the above process for each audio file you wish to convert. Make sure to save each with the unique filename ranging between 3000.raw and 4999.raw.

## Verify the File

You can verify that the settings are correct for this file by re-importing this raw file format and playing the audio file. Click on the File menu and select Import, then Raw Data from the list of choices.

On the Import Raw Data dialog, make sure to select “U-Law” as the format, Byte order as “No endianness”, Channels as “1 Channel (Mono)”, Start offset as “0”, Amount to import as “100%”, and a Sample rate of “8000 Hz”.

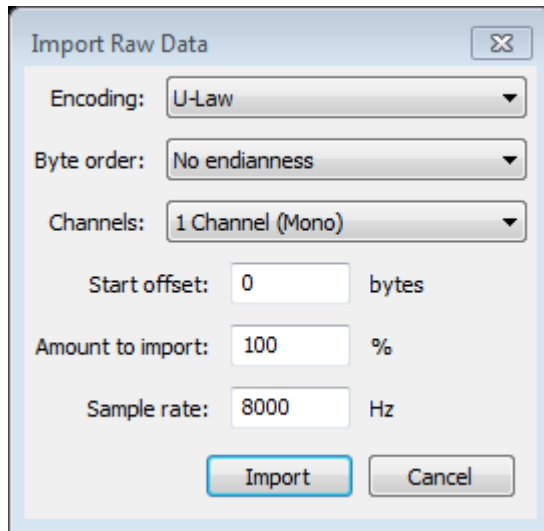

Play back the audio file by clicking the green play arrow to confirm that it is playing back the way you want to hear it on the 7330.

## **Example 2: Recording Audio and Saving as an S-COM Custom Audio File**

1. Make sure you have a microphone set up to do recording. There are quite a number of different possible setups, but commonly a headphone/microphone setup can be plugged into your PC's microphone input. Make sure that Audacity® is set up to read audio from this channel. You may need to go into your control panel to set up the audio channel correctly.
2. Recording is straightforward—simply click the red “record” button and record the sample. You can play back the recording by clicking the Green playback arrow as well as use the Audacity® editing tools to get the audio file to be what you desire. There is much more information and a set of tutorials available to cover these functions at the Audacity® web site.
3. Consider using the same “voice” for generating all of the repeater’s custom audio words for a given message. You may also want to generate words that are already available in the standard speech library vocabulary, but recorded in the new voice. That way any speech message constructed using these custom words will sound as if the same person has spoken the words.

**Notes:**

---

## *Appendix A*

# Programming Tables

---

The tables in this section are used to program the controller. Additionally, the *Command Quick Reference* on page A-53 contains a summary of each command.

---

<b>Programming Tables .....</b>	<b>A-1</b>
Message Levels .....	A-3
Message Control Characters .....	A-4
CW Character Set Tables .....	A-5
Single-Tone Beep Character Set Tables .....	A-7
Dual-Tone Beep Character Set Tables .....	A-10
DTMF Character Set Tables .....	A-12
SELCAL Character Set Table .....	A-15
Speech Character Set Tables .....	A-16
Speech Message Level Change .....	A-16
Speech Intra-Message Delay .....	A-16
Speech Vocabulary Tables .....	A-17
Numbers .....	A-17
Letters .....	A-17
Calendar .....	A-18
Measurements .....	A-18
All Words Alphabetic Listing .....	A-19
Message Run-Time Variables .....	A-29
Scheduler Day Code Table .....	A-30
Tone Code Table .....	A-31
Plectron Tone Code Table .....	A-33
Root Numbers (Commands) by Number .....	A-34
Event Macros by Number .....	A-36
Messages by Number .....	A-39
10 Millisecond Timers by Number .....	A-41
100 Millisecond Timers by Number .....	A-43
1 Second Timers by Number .....	A-44
Path Access Mode by Number .....	A-45
Software Switches by Number .....	A-46
Counters by Number .....	A-49
Booleans by Number .....	A-50
CTCSS Tone Numbers .....	A-52
Command Quick Reference .....	A-53



## Message Level Table

<b>Message Levels</b>									
(PW) 10 <message type> <level> * (see page 6-10)									
Level	Value dB	Level	Value dB	Level	Value dB	Level	Value dB	Level	Value dB
00	0.0	20	-10.0	40	-20.0	60	-30.0	80	-40.0
01	-0.5	21	-10.5	41	-20.5	61	-30.5	81	-40.5
02	-1.0	22	-11.0	42	-21.0	62	-31.0	82	-41.0
03	-1.5	23	-11.5	43	-21.5	63	-31.5	83	-41.5
04	-2.0	24	-12.0	44	-22.0	64	-32.0	84	-42.0
05	-2.5	25	-12.5	45	-22.5	65	-32.5	85	-42.5
06	-3.0	26	-13.0	46	-23.0	66	-33.0	86	-43.0
07	-3.5	27	-13.5	47	-23.5	67	-33.5	87	-43.5
08	-4.0	28	-14.0	48	-24.0	68	-34.0	88	-44.0
09	-4.5	29	-14.5	49	-24.5	69	-34.5	89	-44.5
10	-5.0	30	-15.0	50	-25.0	70	-35.0	90	-45.0
11	-5.5	31	-15.5	51	-25.5	71	-35.5	91	-45.5
12	-6.0	32	-16.0	52	-26.0	72	-36.0	92	-46.0
13	-6.5	33	-16.5	53	-26.5	73	-36.5	93	-46.5
14	-7.0	34	-17.0	54	-27.0	74	-37.0	94	-47.0
15	-7.5	35	-17.5	55	-27.5	75	-37.5	95	-47.5
16	-8.0	36	-18.0	56	-28.0	76	-38.0	96	-48.0
17	-8.5	37	-18.5	57	-28.5	77	-38.5	97	-48.5
18	-9.0	38	-19.0	58	-29.0	78	-39.0	98	-49.0
19	-9.5	39	-19.5	59	-29.5	79	-39.5		

## Message Control Characters

Message Control Characters		
Control Character	Definition	Page
97xx	Message Routing port numbers follow	6-4
9900	CW characters follow	6-13
9901	CW Primary characters follow	6-13
9902	CW Secondary characters follow	6-13
9903	CW Speed Change characters follow	6-15
9904	CW Frequency Change characters follow	6-15
9905	CW Message Level characters follow	6-14
9910	Single-Tone Beep characters follow	6-21
9911	Single-Tone Beep Primary characters follow	6-21
9912	Single-Tone Beep Secondary characters follow	6-21
9913	Single-Tone Beep Message Level characters follow	6-22
9915	Dual-Tone Beep characters follow	6-31
9916	Dual-Tone Beep Primary characters follow	6-31
9917	Dual-Tone Beep Secondary characters follow	6-31
9918	Dual-Tone Beep Message Level characters follow	6-32
9920	Single-Tone Page follows	6-39
9930	Two-Tone Sequential Page follows	6-41
9940	5/6-tone Page follows	6-43
9950	DTMF Page follows	6-45
9955	SELCAL Page follow	6-53
9960	Speech characters follow	6-55
9961	Speech Primary characters follow	6-55
9962	Speech Secondary characters follow	6-55
9963	Speech Message Level characters follow	6-56
9991	Mixed Audio Allowed	6-6
9992	Non-Mixed Audio Only	6-6
9993	Pause characters follow	6-7
9999	Queue the macro that follows for execution	6-8

## CW Character Set Tables

<b>CW Alphanumeric Characters</b>			
Control Character 9900/9901/9902			
Character	Code	Character	Code
0	00	I	18
1	01	J	19
2	02	K	20
3	03	L	21
4	04	M	22
5	05	N	23
6	06	O	24
7	07	P	25
8	08	Q	26
9	09	R	27
A	10	S	28
B	11	T	29
C	12	U	30
D	13	V	31
E	14	W	32
F	15	X	33
G	16	Y	34
H	17	Z	35

<b>CW Speed Change</b>	
Control Character 9900/9901/9902	
Change	Code
Speed to 5 WPM	60
Speed to 7 WPM	61
Speed to 10 WPM	62
Speed to 13 WPM	63
Speed to 15 WPM	64
Speed to 17 WPM	65
Speed to 20 WPM (default)	66
Speed to 24 WPM	67
Speed to 30 WPM	68
Speed to 40 WPM	69

## CW Punctuation and Related Characters

Control Character 9900/9901/9902

Character/Parameter	Symbol	Code
period	.	36
comma	,	37
fraction	/	38
Question	?	39
word space	space	40
end-of-message	(AR)	41
wait	(AS)	42
break	(BK)	43
double dash	(BT)	44
end-of-work	(SK)	45
hyphen	-	46
colon	:	47
semicolon	;	48
parenthesis	( )	49
apostrophe	q	50
exclamation	!	51
quotation	+	52
understood	(SN)	53
at-symbol	@	54

## CW Frequency Change

Control Character 9900/9901/9902

Change	Code
Frequency	59xxxx ( <i>xxxx = tone code</i> )

## CW Message Level Change

Control Character 9905

Change	Code
Message Level	9905xx ( <i>xx = Msg Level</i> )

## Single-Tone Beep Character Set Tables

Factory-Fixed Frequency Beeps								
Control Character 9910/9911/9912								
Freq	Note	Beep	Freq	Note	Beep	Freq	Note	Beep
262Hz	C3	00	659Hz	E4	16	1661Hz	G#5	32
277Hz	C#3	01	698Hz	F4	17	1760Hz	A5	33
294Hz	D3	02	740Hz	F#4	18	1865Hz	A#5	34
311Hz	D#3	03	784Hz	G4	19	1976Hz	B5	35
330Hz	E3	04	831Hz	G#4	20	2093Hz	C6	36
349Hz	F3	05	880Hz	A4	21	2217Hz	C#6	37
370Hz	F#3	06	932Hz	A#4	22	2349Hz	D6	38
392Hz	G3	07	988Hz	B4	23	2489Hz	D#6	39
415Hz	G#3	08	1046Hz	C5	24	2637Hz	E6	40
440Hz	A3	09	1109Hz	C#5	25	2794Hz	F6	41
466Hz	A#3	10	1175Hz	D5	26	2960Hz	F#6	42
494Hz	B3	11	1244Hz	D#5	27	3136Hz	G6	43
523Hz	C4	12	1319Hz	E5	28	3322Hz	G#6	44
554Hz	C#4	13	1397Hz	F5	29	3520Hz	A6	45
587Hz	D4	14	1480Hz	F#5	30	3729Hz	A#6	46
622Hz	D#4	15	1568Hz	G5	31	3951Hz	B6	47

Owner-Fixed Frequency Beeps		
Control Character 9910/9911/9912		
Beep	Owner-Fixed Frequency (Fill-In)	Default Condition
48		500Hz
49		750Hz
50		1000Hz
51		1250Hz
52		1500Hz
53		1750Hz

<b>Single-Tone Beep Message Level Change</b>	
<b>Change</b>	<b>Code</b>
Message Level	9913xx ( <i>xx = Msg Level</i> )

<b>Single-Tone Beep Gap Change Characters</b>	
Control Character 9910/9911/9912	
<b>Beep Gap Change</b>	<b>Code</b>
10mS	60
20mS (default)	61
30mS	62
40mS	63
60mS	64
80mS	65
120mS	66
160mS	67
240mS	68
320mS	69

<b>Single-Tone Beep Duration Change Characters</b>	
Control Character 9910/9911/9912	
<b>Beep Duration Change</b>	<b>Code</b>
10mS	70
20mS	71
30mS	72
40mS	73
60mS (default)	74
80mS	75
120mS	76
160mS	77
240mS	78
320mS	79

<b>Single-Tone Beep Parameters (General)</b>	
Control Character 9910/9911/9912	
<b>Beep Parameter</b>	<b>Code</b>
custom beep	57xxxxyy
custom beep delay	58xx
automatic beep gap OFF (default)	55
automatic beep gap ON	56

## Dual-Tone Beep Character Set Tables

Factory-Fixed Frequency Beeps								
Control Character 9915/9916/9917								
Freq	Note	Beep	Freq	Note	Beep	Freq	Note	Beep
262Hz	C3	00	659Hz	E4	16	1661Hz	G#5	32
277Hz	C#3	01	698Hz	F4	17	1760Hz	A5	33
294Hz	D3	02	740Hz	F#4	18	1865Hz	A#5	34
311Hz	D#3	03	784Hz	G4	19	1976Hz	B5	35
330Hz	E3	04	831Hz	G#4	20	2093Hz	C6	36
349Hz	F3	05	880Hz	A4	21	2217Hz	C#6	37
370Hz	F#3	06	932Hz	A#4	22	2349Hz	D6	38
392Hz	G3	07	988Hz	B4	23	2489Hz	D#6	39
415Hz	G#3	08	1046Hz	C5	24	2637Hz	E6	40
440Hz	A3	09	1109Hz	C#5	25	2794Hz	F6	41
466Hz	A#3	10	1175Hz	D5	26	2960Hz	F#6	42
494Hz	B3	11	1244Hz	D#5	27	3136Hz	G6	43
523Hz	C4	12	1319Hz	E5	28	3322Hz	G#6	44
554Hz	C#4	13	1397Hz	F5	29	3520Hz	A6	45
587Hz	D4	14	1480Hz	F#5	30	3729Hz	A#6	46
622Hz	D#4	15	1568Hz	G5	31	3951Hz	B6	47

Dual-Tone Beep Parameters	
Control Character 9915/9916/9917	
Beep Parameter	Code
custom dual-tone beep	57xxxxyyyyzz
custom beep delay	58xx
automatic beep gap OFF (default)	55
automatic beep gap ON	56



<b>Dual-Tone Beep Gap Change Characters</b>	
Control Character 9915/9916/9917	
<b>Beep Gap Change</b>	<b>Code</b>
10mS	60
20mS (default)	61
30mS	62
40mS	63
60mS	64
80mS	65
120mS	66
160mS	67
240mS	68
320mS	69

<b>Dual-Tone Beep Duration Change Characters</b>	
Control Character 9915/9916/9917	
<b>Beep Duration Change</b>	<b>Code</b>
10mS	70
20mS	71
30mS	72
40mS	73
60mS (default)	74
80mS	75
120mS	76
160mS	77
240mS	78
320mS	79

<b>Dual-Tone Beep Message Level Change</b>	
<b>Change</b>	<b>Code</b>
Message Level	9918xx ( <i>xx = Msg Level</i> )

## DTMF Character Set Tables

<b>DTMF Characters</b>			
Control Character 9950			
<b>DTMF Character</b>	<b>Code</b>	<b>DTMF Character</b>	<b>Code</b>
0	00	8	08
1	01	9	09
2	02	A	10
3	03	B	11
4	04	C	12
5	05	D	13
6	06	*	14
7	07	#	15

<b>DTMF Duration Change Characters</b>	
Control Character 9950	
<b>DTMF Duration Change</b>	<b>Code</b>
30mS	20
40mS	21
50mS	22
60mS	23
70mS	24
80mS	25
90mS	26
100mS (default)	27
150mS	28
200mS	29

<b>DTMF Gap Change Characters</b>	
Control Character 9950	
<b>DTMF Gap Change</b>	<b>Code</b>
20mS	30
30mS	31
40mS	32
50mS	33
60mS	34
70mS	35
80mS	36
90mS	37
100mS (default)	38
150mS	39

<b>DTMF Pause Characters</b>	
Control Character 9950	
<b>DTMF Pause</b>	<b>Code</b>
100mS	40
200mS	41
300mS	42
400mS	43
500mS	44
600mS	45
700mS	46
800mS	47
900mS	48
1000mS	49

<b>DTMF Custom Changes (Duration Gap Pause)</b>		
Control Character 9950		
<b>DTMF Custom Change</b>	<b>Code</b>	<b>Data Digit</b>
custom DTMF duration change (10-990mS)	50xx	0199 x 10mS
custom DTMF duration change (100-9900mS)	51xx	0199 x 100mS
custom DTMF gap change (10-990mS)	52xx	0199 x 10mS
custom DTMF gap change (100-9900mS)	53xx	0199 x 100mS
custom DTMF pause (10-990mS)	54xx	0199 x 10mS
custom DTMF pause (100-9900mS)	55xx	0199 x 100mS
to ignore each custom DTMF change code		enter 00 for xx in any of above codes

## SELCAL Character Set Tables

<b>SELCAL Characters</b>		
<b>Designation</b>	<b>Frequency Hz</b>	<b>Digit Code</b>
Red A	312.6	00
Red B	346.7	01
Red C	384.6	02
Red D	426.6	03
Red E	473.2	04
Red F	524.8	05
Red G	582.1	06
Red H	645.7	07
Red J	716.1	08
Red K	794.3	09
Red L	881	10
Red M	977.2	11
Red P	1083.9	12
Red Q	1202.3	13
Red R	1333.5	14
Red S	1479.1	15

## Speech Character Set Tables

<b>Speech Message Level Change</b>	
<b>Change</b>	<b>Code</b>
Message Level	9963xx ( <i>xx = Msg Level</i> )

<b>Speech Intra-Message Delay</b>		
<b>Delay</b>	<b>Code</b>	<b>Data Digits</b>
Speech Intra-Message Delay (10-990mS)	70xx	00-99 x 10mS
Speech Intra-Message Delay (100-9900mS)	71xx	00-99 x 100mS

<b>Speech Vocabulary Tables</b>							
Control Character 9960/9961/9962							
<b>Numbers</b>							
Word	Code	Word	Code	Word	Code	Word	Code
zero	0000	sixth	0012	twelve	0023	twentieth	0034
one	0001	seven	0013	thirteenth	0024	thirty	0035
first	0002	eighth	0014	fourteen	0025	forty	0036
two	0003	ninth	0015	fifteen	0026	fifty	0037
second	0004	ten	0016	sixteen	0027	sixty	0038
three	0005	eleven	0017	seventeen	0028	seventy	0039
third	0006	twelve	0018	eighteen	0029	eighty	0040
four	0007	thirteen	0019	nineteen	0030	ninety	0041
fourth	0008	fourteen	0020	twenty	0031	hundred	0042
five	0009	fifteen	0021		0032	thousand	0043
fifth	0010	sixteen	0022		0033	million	0044
six	0011						

<b>Speech Vocabulary Tables</b>							
Control Character 9960/9961/9962							
<b>Letters</b>							
Word	Code	Word	Code	Word	Code	Word	Code
A	0045	H	0052	O	0059	U	0065
B	0046	I	0053	P	0060	V	0066
C	0047	J	0054	Q	0061	W	0067
D	0048	K	0055	R	0062	X	0068
E	0049	L	0056	S	0063	Y	0069
F	0050	M	0057	T	0064	Z	0070
G	0051	N	0058				

<b>Speech Vocabulary Tables</b>							
Control Character 9960/9961/9962							
<b>Calendar</b>							
<b>Word</b>	<b>Code</b>	<b>Word</b>	<b>Code</b>	<b>Word</b>	<b>Code</b>	<b>Word</b>	<b>Code</b>
January	0071	Sunday	0083	day	0096	today	0109
February	0072	Monday	0084	days	0097	tomorrow	0110
March	0073	Tuesday	0085	hour	0098	tonight	0111
April	0074	Wednesday	0086	hours	0099	yesterday	0112
May	0075	Thursday	0087	minute	0100	weekday	0113
June	0076	Friday	0088	minutes	0101	weekend	0114
July	0077	Saturday	0089	second	0102	weekly	0115
August	0078	date	0090	seconds	0103	AM	0116
September	0079	time	0091	week	0104	PM	0117
October	0080	year	0092	morning	0105	noon	0118
November	0081	yearly	0093	afternoon	0106	oclock	0119
December	0082	month	0094	evening	0107	zulu	0120
		monthly	0095	night	0108		

<b>Speech Vocabulary Tables</b>							
Control Character 9960/9961/9962							
<b>Measurements</b>							
<b>Word</b>	<b>Code</b>	<b>Word</b>	<b>Code</b>	<b>Word</b>	<b>Code</b>	<b>Word</b>	<b>Code</b>
feet	0121	micro	0129	point	0137	Hertz	0145
meter	0122	milli	0130	Amps	0138	ohm	0146
meters	0123	kilo	0131	byte	0139	percent	0147
inch	0124	mega	0132	Celsius	0140	power	0148
mile	0125	minus	0133	current	0141	voltage	0149
miles	0126	plus	0134	degree	0142	volts	0150
pico	0127	decimal	0135	degrees	0143	watt	0151
nano	0128	dot	0136	Fahrenheit	0144	watts	0152



All Words Alphabetic Listing							
Word	Code	Word	Code	Word	Code	Word	Code
<b>A</b>	0045	alert	0205	Arizona	0448	band	0223
abeam	0386	all	0206	Arkansas	0449	Bangor	0480
Abington	0388	Allenton	0421	armed	0450	bank	0481
Able	0387	Allentown	0422	army	0451	Barbara	0482
able	0389	aloft	0423	arrival	0452	barometric	0483
abnormal	0390	alpha	0424	as	0215	bars	0484
abort	0391	alternate	0425	ask	0217	base	0224
about	0392	altimeter	0426	Aspen	0453	bath	0485
above	0393	altitude	0427	assign	0454	Baton Rouge	0486
accelerate	0394	always	0428	assistance	0455	battery	0225
accelerated	0395	AM	0116	association	0218	baud	0487
access	0396	amateur	0207	astro	0456	Bavarian	0488
acknowledge	0397	amateurs	0208	at	0219	bay	0489
action	0398	amber	0429	Atlanta	0457	beacon	0490
activated	0201	ambulance	0430	Atlantic	0458	beam	0491
activating	0202	America	0431	attempt	0459	bearing	0492
active	0203	American	0432	attention	0460	beautiful	0493
activity	0399	Amp	0433	ATV	0461	Beaverton	0494
Adam	0400	amplifier	0209	audio	0220	beer	0226
address	0401	Amps	0138	August	0078	bell	0495
adjust	0402	an	0210	Augusta	0462	below	0496
advise	0403	analog	0211	aural	0463	Bernadino	0497
advisory	0404	Anchorage	0434	Austin	0464	between	0498
aerial	0405	and	0212	authorized	0465	big	0499
affirmative	0406	Angeles	0435	auto	0221	Billings	0500
aft	0407	anger	0436	automatic	0466	Birmingham	0501
afternoon	0106	angle	0437	autopatch	0222	Bismarck	0502
again	0408	Annapolis	0438	autopilot	0467	black	0503
ahead	0409	announcement	0439	auxiliary	0468	Bloomsburg	0504
air	0410	answer	0440	available	0469	blowing	0505
aircraft	0411	antenna	0213	ave	0470	blue	0506
airforce	0412	Appalachian	0441	avenue	0471	bluff	0507
airport	0413	apple	0442	average	0472	Boeing	0508
airspeed	0414	Appleton	0443	<b>B</b>	0046	Boise	0509
Alabama	0415	approach	0444	back	0473	bolt	0510
alarm	0204	approaches	0445	backbone	0474	boost	0511
alarmed	0416	April	0074	backhaul	0475	booster	0512
Alaska	0417	APU	0446	backup	0476	Boston	0513
Albany	0418	are	0214	bad	0477	bound	0514
Alberta	0419	area	0447	Baker	0478	box	0515
Albuquerque	0420	Ares	0216	Baltimore	0479	Bozo	0516

All Words Alphabetic Listing							
Word	Code	Word	Code	Word	Code	Word	Code
Bradford	0517	cancel	0231	circuit	0589	condition	0624
brake	0518	capacitance	0552	circus	0591	configuration	0625
braking	0519	capacitor	0553	cities	0592	conflicts	0626
branch	0520	Cape May	0554	city	0593	conifer	0154
Bravo	0521	car	0555	class	0594	connect	0627
break	0522	Carbondale	0556	Claude	0595	Connecticut	0628
breaker	0523	cargo	0557	clear	0596	connector	0629
brew	0227	Carlos	0558	clearance	0597	constant	0630
bridge	0524	carmel	0559	climb	0598	consumption	0631
Bridgeport	0525	Carolina	0560	clinch	0599	contact	0240
Bristol	0526	carriage	0561	clock	0234	contactor	0632
British	0527	carrier	0562	close	0600	control	0241
broadcast	0528	Carson City	0563	close2	0601	controller	0242
broaden	0529	case	0564	closed	0235	converging	0633
Broadway	0530	cast	0565	closure	0602	converter	0634
broken	0531	cat	0566	clown	0603	cool	0635
Bronx	0532	cathode	0567	club	0236	cooling	0636
Brookfield	0533	caution	0568	coast	0604	copper	0637
brown	0534	Cedar Rapids	0569	coax	0605	correct	0638
Brynmarwr	0535	Cedarburg	0570	code	0237	county	0639
bucks	0536	ceiling	0571	coil	0606	course	0640
Buffalo	0537	Celsius	0140	cold	0607	coverage	0641
building	0538	center	0572	college	0608	cowl	0642
Burlington	0539	centi	0573	Colorado	0153	craft	0643
busy	0228	Centigrade	0574	Columbia	0609	crane	0644
button	0540	central	0575	Columbus	0610	crescent	0645
by	0541	cerro	0576	com	0238	cross	0646
byte	0139	Chambersburg	0577	combiner	0611	crosswind	0647
<b>C</b>	0047	change	0232	come	0612	crystal	0649
cabin	0542	changeover	0578	command	0613	Crystal Lake	0648
calibrate	0543	channel	0579	common	0614	CTCSS	0243
calibration	0544	charge	0580	communication	0615	culvert	0650
California	0545	Charleston	0581	communications	0616	current	0141
call	0229	Charlie	0582	compact	0618	CW	0651
calling	0230	Charlotte	0583	compact flash	0617	cycle	0652
callsign	0546	check	0233	complete	0239	cylinder	0653
calm	0547	Chester	0584	complex	0619	<b>D</b>	0048
Cambridge	0548	Cheyenne	0585	compressor	0620	damage	0654
camelback	0549	Chicago	0586	computer	0621	danger	0656
Canada	0550	Chippewa Falls	0587	Concord	0622	danger whoop	0655
Canadian	0551	choice	0588	Concorde	0623	dark	0657

All Words Alphabetic Listing							
Word	Code	Word	Code	Word	Code	Word	Code
data	0658	digital	0688	<b>E</b>	0049	error	0261
date	0090	dinner	0689	Eagles Peak	0721	escape	0749
davenport	0659	dip	0690	Earth	0722	estimated	0750
day	0096	direct	0691	East	0723	ETA	0751
days	0097	direction	0692	easy	0724	evacuate	0752
Dayton	0660	directory	0693	Eau Claire	0725	evacuation	0753
December	0082	disable	0247	echo	0726	evening	0107
decimal	0135	disabled	0248	Eckley	0727	event	0754
decrease	0244	disarm	0694	Edison	0728	every	0755
decreasing	0245	discharge	0695	Edmonton	0729	evil	0756
default	0661	disconnect	0696	efficiency	0730	exciter	0757
deflector	0662	dish	0697	Egg Harbor	0731	exclusion	0758
degree	0142	dismal	0698	EHF	0732	exist	0759
degrees	0143	dispatcher	0699	eight	0015	existing	0760
dehydrator	0663	display	0700	eighteen	0031	exit	0262
deice	0664	divide	0701	eighth	0016	expect	0761
Delaware	0665	divided	0702	eighty	0040	exterior	0762
delay	0666	do	0703	electric	0733	external	0763
delete	0667	dog	0704	electrician	0734	extreme	0764
Delray	0668	Doh	0705	electricity	0735	<b>F</b>	0050
delta	0669	door	0249	elevation	0736	fade	0765
deluxe	0670	doors	0250	eleven	0022	fail	0766
Denver	0155	dot	0136	Elizabeth	0737	failed	0767
department	0671	double	0706	email	0257	failure	0263
departure	0672	Dover	0707	emergency	0738	Fairport	0768
depleted	0673	down	0251	empty	0739	false	0769
depth	0674	downlink	0708	EMS	0740	fan	0770
Des Moines	0675	downwind	0709	enable	0254	Fancy Hill	0771
desert	0676	drive	0710	enabled	0255	Farad	0772
detect	0677	driver	0711	end	0741	Fahrenheit	0144
detected	0678	drizzle	0712	endless	0742	Fargo	0773
detector	0679	DTMF	0252	energy	0743	farm	0774
Detroit	0680	Dubois	0713	engage	0744	fast	0775
deviation	0681	Dubuque	0714	engine	0745	faster	0776
device	0682	duhhh	0253	engineering	0746	fat	0777
dial	0683	Duluth	0715	enter	0256	fault	0778
dialed	0684	dump	0716	equal	0258	February	0072
dialing	0246	duplexer	0717	equipment	0747	federal	0779
did	0685	dust	0718	erase	0259	feedline	0780
Diego	0686	DVR	0719	erased	0260	feet	0121
diesel	0687	dynamic	0720	Erie	0748	female	0781

All Words Alphabetic Listing							
Word	Code	Word	Code	Word	Code	Word	Code
femto	0782	forward	0816	George	0848	happy holidays	0883
Fernando	0783	four	0007	Georgia	0849	hard	0884
fest	0784	fourteen	0026	Germantown	0850	hardline	0885
festival	0785	fourth	0008	get	0269	Harrisburg	0886
field	0786	fox	0817	Gilbert	0851	Harry	0887
fifteen	0027	foxtrot	0818	Glendale Heights	0852	Hartford	0888
fifth	0010	Francisco	0819	glide	0853	has	0889
fifty	0037	Frankenmuth	0820	go	0270	have	0274
filament	0787	Frankfort	0821	gold	0854	Hawaii	0890
file	0788	Franklin	0822	golf	0855	haze	0891
filed	0789	Fredericton	0823	good	0860	head	0892
final	0790	free	0824	good afternoon	0856	heading	0893
fire	0791	freedom	0825	good bye	0271	heat	0894
first	0002	Freeport	0826	good evening	0857	heating	0895
fish	0792	freeze	0827	good morning	0858	heavy	0896
five	0009	freezing	0828	good night	0859	Helena	0897
flag	0793	French	0829	grain	0861	Heliac	0898
flair	0794	frequency	0265	Grand Rapids	0862	hello	0275
flame	0795	Fresno	0830	gray	0863	help	0276
flameout	0796	Friday	0088	greater	0865	Henry	0899
flaps	0797	friendly	0831	greater than	0864	here	0900
flash	0798	from	0266	green	0867	Hertz	0145
flat	0799	front	0832	Green Bay	0866	HF	0901
flight	0800	fuel	0833	Greenwich	0868	Hicks	0902
flightwatch	0801	full	0267	grid	0869	high	0277
flood	0802	fun	0834	ground	0870	higher	0903
flooded	0803	function	0835	group	0871	highway	0904
floor	0804	fuse	0836	gun	0872	hill	0905
Florence	0805	<b>G</b>	0051	Gundish	0873	hold	0278
Florida	0806	galley	0837	gust	0874	home	0906
flow	0807	gallons	0838	gusting to	0875	Honolulu	0907
FM	0808	gap	0839	<b>H</b>	0052	horizontal	0908
fog	0809	garden	0840	hail	0876	hospital	0909
Fond Du Lac	0810	gas	0841	half	0877	hot	0910
for	0264	gate	0268	Halifax	0878	hotel	0911
forest	0811	gateway	0842	ham	0272	hour	0098
forever	0812	gauge	0843	Hamburg	0879	hours	0099
fork	0813	gear	0844	hamfest	0273	Houston	0912
Forkston	0814	generate	0845	hamvention	0880	how	0913
fort	0815	generator	0846	Hancock	0881	http www	0279
forty	0036	Geneva	0847	hang	0882	hundred	0042

All Words Alphabetic Listing							
Word	Code	Word	Code	Word	Code	Word	Code
hunt	0914	instrument	0946	Kenley	0980	lights	0292
hurricane	0915	instruments	0947	Kenosha	0981	Lima	1016
<b>I</b>	0053	intakes	0948	Kentucky	0982	limit	1017
ice	0916	interface	0949	kerchunk	0983	Lincoln	1018
icing	0917	internet	0950	Kewaunee	0984	line	0293
Ida	0918	interrupt	0951	key	0289	link	0294
Idaho	0919	interstate	0952	keyboard	0985	list	0295
identification	0920	interval	0953	kicks	0986	listen	1019
identifier	0280	intranet	0954	kill	0987	little	1021
identity	0921	intruder	0955	killer	0988	Little Rock	1020
idle	0281	invalid	0956	kilo	0131	load	1022
if	0282	Iowa	0957	king	0989	localizer	1023
ignite	0922	IRLP	0958	knob	0990	lock	1024
ignition	0923	iron	0959	knots	0991	locked	1025
Illinois	0924	is	0287	<b>L</b>	0056	log	1026
immediate	0925	island	0960	Labrador	0992	logic	1027
immediately	0926	isolation	0961	Lacrosse	0993	Loma Prieta	1028
in	0283	it	0288	Lafayette	0994	long	1029
inactive	0927	item	0962	lake	0995	loop	1030
inbound	0928	its	0963	lambs	0996	Los	1032
inch	0124	<b>J</b>	0054	land	0997	Los Angeles	1031
increase	0284	Jackson	0964	landing	0998	Louis	1033
increasing	0285	Jacksonville	0965	Lansing	0999	Louisiana	1034
India	0929	Janesville	0966	large	1000	love	1035
Indiana	0930	January	0071	Las Vegas	1001	low	0296
Indianapolis	0931	Jefferson	0967	last	1002	lower	0297
indicate	0932	jig	0968	Lauderdale	1003	Lycoming	1036
indicated	0933	Joaquin	0969	launch	1004	Lynch	1037
indicator	0934	John	0970	league	1005	Lynchburg	1038
indigo	0935	join	0971	leak	1006	<b>M</b>	0057
indoor	0936	joint	0972	lean	1007	machine	0298
inductor	0937	Juliet	0973	leave	1008	Macon	1039
industries	0938	July	0077	left	1009	macro	1040
inflight	0939	junction	0974	leg	1010	Madison	1041
information	0286	June	0076	less than	0290	magneto	1042
inner	0940	Juneau	0975	let	1011	mail	1043
input	0941	just	0976	level	1012	main	1044
inside	0942	<b>K</b>	0055	Lexington	1013	maintain	1045
inspect	0943	KA9FUR	0977	lick	1014	make	1046
inspector	0944	Kansas	0978	lid	1015	man	0299
instruction	0945	Kellysville	0979	light	0291	Manchester	1047

All Words Alphabetic Listing							
Word	Code	Word	Code	Word	Code	Word	Code
Manhattan	1048	middle	1079	moron	1109	nine	0017
Manitoba	1049	midpoint	1080	moron alert	1107	niner	0018
Manitowoc	1050	Mike	1081	moron whoop	1108	nineteen	0032
manual	0300	mile	0125	Morse	1110	ninety	0041
many	1051	miles	0126	motor	1111	ninth	0019
March	0073	military	1082	mount	1112	no	0310
marine	1052	mill	1083	mountain	1113	nominal	1141
marines	1053	milli	0130	mouse	1114	none	1142
mark	1054	million	0044	move	1115	noon	0118
marker	1055	Milwaukee	1084	moving	1116	Norfolk	1143
Marquette	1056	min	1085	much	1117	normal	1144
Maryland	1057	mini	1086	my	1118	Noroeste	1145
Massachusetts	1058	Minneapolis	1087	<b>N</b>	0058	North	1149
mast	1059	Minnesota	1088	N3KZ	1119	North Carolina	1146
master	1060	minus	0133	N3KZed	1120	North Dakota	1147
May	0075	minute	0100	nan	1121	North Prarie	1148
Mayberry	1061	minutes	0101	Nancy	1122	Northeast	1150
mayday	1062	Mississippi	1089	nano	0128	Northwest	1151
me	1063	Missouri	1090	Naperville	1123	Norton	1152
mean	1064	mist	1091	narrows	1124	not	0311
measure	1065	mixture	1092	Nashville	1125	notice	1153
medical	1066	mobile	0304	national	1126	Nova Scotia	1154
medium	1067	mode	1093	navy	1127	November	0081
meet	0301	modem	1094	near	1128	now	1155
meeting	0302	moderate	1095	Nebraska	1129	number	0312
mega	0132	modify	1096	negative	0306	numbers	1156
Memphis	1068	modulation	1097	net	0307	Nunavut	1157
Menomonee Falls	1069	module	1098	network	1130	<b>O</b>	0059
Mercury	1070	Moline	1099	neutral	1131	oak	1158
message	1071	Monday	0084	Nevada	1132	Obispo	1159
messages	0303	monitor	1100	new	0308	oboe	1160
meter	0122	mono	1101	New Hampshire	1133	obscured	1161
metering	1072	Monroe	1102	New Jersey	1134	ocean	1162
meters	0123	Montana	1103	New Mexico	1135	oclock	0119
Mexico	1073	Montgomery	1104	New Orleans	1136	October	0080
Michigan	1074	month	0094	New York	1137	of	0313
micro	0129	monthly	0095	Newark	1138	off	0314
microphone	1075	Montpelier	1105	Newfoundland	1139	oh	1163
microwave	1076	more	1106	Newtown	1140	Ohio	1164
mid	1078	more than	0305	next	0309	ohm	0146
mid Wisconsin	1077	morning	0105	night	0108	ohms	1165



All Words Alphabetic Listing							
Word	Code	Word	Code	Word	Code	Word	Code
oil	1166	<b>P</b>	0060	plan	1228	<b>Q</b>	0061
okay	1167	Pacific	1198	plant	1229	quad	1261
Oklahoma	1168	pad	1199	plate	1230	quarter	1262
old	1169	page	0323	play	1231	Quebec	1263
Olympia	1170	pair	1200	please	0331	Quebec2	1264
Omaha	1171	pallets	1201	PLL	1232	Queen	1265
omni	1172	panther	1202	plus	0134	question	1266
on	0315	papa	1203	PM	0117	<b>R</b>	0062
one	0001	parade	1204	point	0137	Races	1267
only	1173	parallel	1205	polar	1233	Racine	1268
Ontario	1174	parking	1206	polarization	1234	radar	1269
Opaca	1175	partially	0324	polarized	1235	radial	1270
open	0316	pass	0325	police	0332	radio	0335
operate	1176	passed	0326	pond	1236	radios	0336
operational	1177	password	1207	poor	1237	rail	1271
operator	0317	patch	0327	port	1238	rain	1272
optical	1178	path	0328	portable	1239	raise	1273
or	1179	Paul	1208	Portland	1240	Raleigh	1274
orange	1180	peak	1209	position	1241	range	1275
Ord	1181	pearl	1210	pots	1242	rate	1276
order	1182	pen	1211	pound	0333	reading	1277
Oregon	1183	pending	1212	power	0148	ready	0337
originate	1184	Pennsylvania	1213	powerhouse	1243	rear	1278
Oscar	1185	Penobscot	1214	preamplifier	1244	receive	0338
Oshkosh	1186	Peoria	1215	press	1245	receiver	0339
other	0318	per	0329	pressure	1246	recorded	1279
Ottawa	1187	percent	0147	Prince Edward	1247	recorder	1280
ouch	0319	period	1216	Princeton	1248	red	1281
our	0320	Perry	1217	priority	0334	Redding	1282
out	0321	Peter	1218	probe	1249	reflected	1283
outdoor	1188	phase	1219	program	1250	refueling	1284
outer	1189	Philadelphia	1220	propane	1251	regenerate	1285
output	1190	Phoenix	1221	props	1252	relay	1286
outside	1191	phone	0330	Providence	1253	release	1287
over	0322	pick	1222	Provo	1254	remark	1288
overcast	1192	pico	0127	pull	1255	remote	0340
overload	1193	Pierre	1223	pulse	1256	repair	1289
overlook	1194	pilot	1224	pumps	1257	repeat	0341
overspeed	1195	pine	1225	purple	1258	repeater	0342
Owego	1196	pink	1226	push	1259	report	1290
Oxford	1197	PL	1227	put	1260	request	1291

All Words Alphabetic Listing							
Word	Code	Word	Code	Word	Code	Word	Code
rescue	1292	Salem	1331	serial	1367	snow	1397
reset	1293	Salinas	1332	service	0345	solar	1398
resistance	1294	Salt Lake City	1333	set	0346	sound	1399
resistor	1295	San	1335	seven	0013	South	1403
response	1296	San Louis Obispo	1334	seventeen	0030	South Carolina	1400
return	1297	sand	1336	seventh	0014	South Dakota	1401
reverse	1298	Sandy	1337	seventy	0039	South Mountain	1402
RF	1299	Santa Fe	1338	severe	1368	Southeast	1404
Rhode Island	1300	Santiago	1339	sewage	1369	southern	1405
rich	1301	Saskatchewan	1340	Seymour	1370	Southwest	1406
Richfield	1302	Saturday	0089	Sheboygan	1371	space	1407
Richland	1303	Savanna	1341	SHF	1372	spare	1408
Richmond	1304	save	1342	shoals	1373	speak	1409
ridge	1305	scale	1343	short	1374	speaker	1410
rig	1306	scatter	1344	shortwave	1375	special	1411
right	1307	scattered	1345	showers	1376	speed	1412
ring	1308	Schaumburg	1346	shut	1377	spill	1413
river	1309	schedule	1347	shuttle	1378	spirit	1414
road	0343	scheduled	1348	side	1379	spoil	1415
Roanoke	1310	scheduler	1349	Sierra	1380	spoilers	1416
Rochester	1311	school	1350	sighting	1381	spray	1417
Rockford	1312	science	1351	Sigmat	1382	Springfield	1418
rocky	1314	SCOM	1352	sign	1383	square	1419
Rocky Ridge	1313	Scranton	1353	signal	1384	squawk	1420
Rodman	1315	screen	1354	silver	1385	squawking	1421
Roger	1316	sea	1355	simulcast	1386	squelch	1422
rollout	1317	search	1356	single	1387	SSB	1423
Romeo	1318	Seattle	1357	Sioux Falls	1388	stabilize	1424
room	1319	second	0004	site	1389	stabilizer	1425
route	1320	seconds	0103	six	0011	stable	1426
Roxboro	1321	security	1358	sixteen	0028	stall	1427
RPU	1322	select	0344	sixteenth	0029	standby	1428
RS232	1323	selected	1359	sixth	0012	star	0347
run	1324	selector	1360	sixty	0038	starboard	1429
running	1325	self destruct	1361	Skokie	1390	start	0348
runway	1326	semaphore	1362	sky warn	1391	state	1430
<b>S</b>	0063	send	1363	sleet	1392	station	1431
S meter	1327	sensor	1364	slope	1393	stationary	1432
Sacramento	1328	sent	1365	slower	1394	status	1433
safe	1329	September	0079	small	1395	stereo	1434
Saint Paul	1330	sequence	1366	smoke	1396	stern	1435



All Words Alphabetic Listing							
Word	Code	Word	Code	Word	Code	Word	Code
STL	1436	terminal	1467	tool	0363	two	0003
stop	0349	terminate	1468	Topeka	1490	type	1523
storm	1437	terminated	1469	tornado	1491	<b>U</b>	0065
street	1438	territories	1470	Toronto	1492	UHF	1524
strength	1439	territory	1471	total	1493	uncle	1525
strobe	1440	test	0355	touch	1494	under	0366
structure	1441	Texas	1472	touchdown	1495	unicom	1526
studio	1442	than	1473	Towanda	1496	uniform	1527
sugar	1443	Thank You	1474	tower	1497	union	1528
Summerfest	1444	that	1475	town	1498	unit	1529
Sunday	0083	thaw	1476	track	1499	United States	1530
sunset	1445	the	0356	tracking	1500	university	1531
superior	1446	the2	0357	trade	1501	unlimited	1532
supply	1447	then	1477	traffic	1502	unlock	1533
Sussex	1448	there	1478	transfer	1503	until	0367
swapfest	1449	thermal	1479	transformer	1504	up	0368
switch	0350	thin	1480	transition	1505	uplink	1534
switched	1450	thinly	1481	transmit	0364	UPS	1535
switching	1451	thir	1482	transmitter	0365	use	0369
sword	1452	third	0006	treatment	1506	use2	0370
SWR	1453	thirteen	0025	Trenton	1507	used	1536
synced	1454	thirtieth	1483	trigger	1508	Utah	1537
sysop	1455	thirty	0035	trim	1509	utility	1538
system	0351	this	0358	trip	1510	<b>V</b>	0066
<b>T</b>	0064	this is	0359	tripped	1511	vaca	1539
Tahoe	1456	this is the	1484	TRL	1512	vacuum	1540
tall	1457	Thompson	1485	true	1513	valley	1542
Tallahassee	1458	thousand	0043	trunk	1514	Valley Forge	1541
tango	1459	three	0005	try	1515	valve	1543
tank	1460	thunder	1486	TSL	1516	variable	1544
target	1461	Thursday	0087	tube	1517	VCO	1545
Tassajera	1462	time	0091	Tuesday	0085	vector	1546
taxi	1463	timeout	1487	tug	1518	vectors	1547
tear	1464	timer	0360	tunnel	1519	vera	1548
teen	0352	times	0361	turbulence	1520	verify	0371
telemetry	1465	today	0109	turn	1521	Vermont	1549
telephone	0353	Tollsville	1488	turquoise	1522	version	1550
temperature	0354	tomorrow	0110	twelfth	0024	vertical	1551
ten	0020	tone	1489	twelve	0023	very	1552
Tennessee	1466	tonight	0111	twentieth	0034	VFR	1553
tenth	0021	too	0362	twenty	0033	VHE	1554

All Words Alphabetic Listing							
Word	Code	Word	Code	Word	Code	Word	Code
VHF	1555	watt	0151	Williamsport	1593	<b>Y</b>	0069
Victor	1556	watts	0152	Willie	1594	yada yada yada	1616
Victoria	1557	Waukesha	1577	Wilmington	1595	YAGI	1617
video	1558	Wausau	1578	win	1596	Yankee	1618
Violet	1559	wave	1579	wind	1597	yard	1619
Virginia	1561	way	0375	window	1598	year	0092
Virginia Beach	1560	we	0376	windows	0380	yearly	0093
visibility	1562	weather	0377	windspeed	1599	yellow	1620
visual	1563	web	1580	Winnebago	1600	yes	1621
voice	1564	Wednesday	0086	Wisconsin	1602	yesterday	0112
voltage	0149	week	0104	Wisconsin Interstate Network	1601	Ynez	1622
volts	0150	weekday	0113	with	0381	yoke	1623
volume	1565	weekend	0114	within	1603	york	1624
VOR	1566	weekly	0115	without	1604	you	0383
vortac	1567	welcome	0378	wolf	1605	you ve	0385
VSWR	1568	well	1581	work	1606	young	1625
<b>W</b>	0067	Welsh	1582	working	1607	your	0384
W9HHX	1569	west	1584	works	1608	yours	1626
wait	0372	West Virginia	1583	world	1609	Yukon	1627
wake	1570	what	1585	WR3IRS	1610	<b>Z</b>	0070
warning	0373	whiskey	1586	wrist	1611	zebra	1628
Warren	1571	white	1587	wrong	0382	zed	1629
Washington	1572	Wichita	1588	WWV	1612	zero	0000
waste	1573	wide	1589	WWW	1613	zone	1630
watch	0374	wilco	1590	Wyoming	1614	zulu	0120
water	1574	Wilkesbury	1591	<b>X</b>	0068		
Waterdale	1575	will	0379	X ray	1615		
Waterford	1576	William	1592				

<b>Message Run-Time Variables</b>		
<b>Run-Time Variable</b>	<b>Meaning</b>	<b>Example</b>
<b>CW Date and Time</b>		
9810	hour & minute, 12-hr format, CW	2 45
9811	AM/PM, CW	PM
9812	hour & minute, 24-hr format, CW	14 45
9813	day of week, CW	WED
9814	month, CW	JAN
9815	day of Month, CW	1
9816	Seconds, CW	27 in CW
<b>Speech Date and Time</b>		
9820	hour & minute, 12-hr format, speech	two forty-five
9821	AM/PM, speech	PM
9823	same as 9824 without %hours+&%minutes+, uses %zero+	Fourteen zero-five
9824	hour & minute, 24-hr format, speech	14 hours, 45 minutes
9825	same as 9824 without %hours+&%minutes+, uses %h+	Fourteen oh-five
9826	day of week, speech	Wednesday
9827	cardinal day-of-month, speech	One
9828	ordinal day-of-month, speech	First
9829	month, speech	January
9831	%morning, afternoon, evening+, speech	Afternoon
9832	Seconds, speech	Twenty-seven
9833	Year, speech	Twenty seventeen
9834	Year, speech	Two thousand seventeen
<b>Datatypes</b>		
9840 0pxx [wc0 wc1]	Booleans	%zero+, %one+
9841 0pxx [wc0 wc1]	Software Switches	%zero+, %one+
9850 0pxx	Counters	%two+
9851 rpxx	Timers	%one point six five+
9852 xxmm	A-to-D	%thirteen point two+
<b>Miscellaneous Variables</b>		
9899	Software Version, speech	Three point four point zero

Notes on datatype parameters:

r = range of timer

p = port number

xx = value number

wc0 = wordcode spoken when the value is zero

wc1 = wordcode spoken when the value is one

mm = meter face to use when formatting speech, 00 for an unscaled reading

<b>Scheduler Day Code Table</b>			
<b>Day Code</b>	<b>Explanation</b>	<b>Day Code</b>	<b>Explanation</b>
01-31	calendar day-of-month	58	3rd Wednesday of month
32	weekdays (Mon-Fri)	59	3rd Thursday of month
33	weekends (Sat-Sun)	60	3rd Friday of month
34	Sundays	61	3rd Saturday of month
35	Mondays	62	4th Sunday of month
36	Tuesdays	63	4th Monday of month
37	Wednesdays	64	4th Tuesday of month
38	Thursdays	65	4th Wednesday of month
39	Fridays	66	4th Thursday of month
40	Saturdays	67	4th Friday of month
41	1st Sunday of month	68	4th Saturday of month
42	1st Monday of month	69	5th Sunday of month
43	1st Tuesday of month	70	5th Monday of month
44	1st Wednesday of month	71	5th Tuesday of month
45	1st Thursday of month	72	5th Wednesday of month
46	1st Friday of month	73	5th Thursday of month
47	1st Saturday of month	74	5th Friday of month
48	2nd Sunday of month	75	5th Saturday of month
49	2nd Monday of month	76	Last Sunday of month
50	2nd Tuesday of month	77	Last Monday of month
51	2nd Wednesday of month	78	Last Tuesday of month
52	2nd Thursday of month	79	Last Wednesday of month
53	2nd Friday of month	80	Last Thursday of month
54	2nd Saturday of month	81	Last Friday of month
55	3rd Sunday of month	82	Last Saturday of month
56	3rd Monday of month	99	every day ( <i>wild card</i> )
57	3rd Tuesday of month		

Tone Code Table											
Freq	Code	Freq	Code	Freq	Code	Freq	Code	Freq	Code	Freq	Code
260	0000	460	0040	660	0080	860	0120	1060	0160	1260	0200
265	0001	465	0041	665	0081	865	0121	1065	0161	1265	0201
270	0002	470	0042	670	0082	870	0122	1070	0162	1270	0202
275	0003	475	0043	675	0083	875	0123	1075	0163	1275	0203
280	0004	480	0044	680	0084	880	0124	1080	0164	1280	0204
285	0005	485	0045	685	0085	885	0125	1085	0165	1285	0205
290	0006	490	0046	690	0086	890	0126	1090	0166	1290	0206
295	0007	495	0047	695	0087	895	0127	1095	0167	1295	0207
<b>300</b>	0008	<b>500</b>	0048	<b>700</b>	0088	<b>900</b>	0128	<b>1100</b>	0168	<b>1300</b>	0208
305	0009	505	0049	705	0089	905	0129	1105	0169	1305	0209
310	0010	510	0050	710	0090	910	0130	1110	0170	1310	0210
315	0011	515	0051	715	0091	915	0131	1115	0171	1315	0211
320	0012	520	0052	720	0092	920	0132	1120	0172	1320	0212
325	0013	525	0053	725	0093	925	0133	1125	0173	1325	0213
330	0014	530	0054	730	0094	930	0134	1130	0174	1330	0214
335	0015	535	0055	735	0095	935	0135	1135	0175	1335	0215
340	0016	540	0056	740	0096	940	0136	1140	0176	1340	0216
345	0017	545	0057	745	0097	945	0137	1145	0177	1345	0217
350	0018	550	0058	750	0098	950	0138	1150	0178	1350	0218
355	0019	555	0059	755	0099	955	0139	1155	0179	1355	0219
360	0020	560	0060	760	0100	960	0140	1160	0180	1360	0220
365	0021	565	0061	765	0101	965	0141	1165	0181	1365	0221
370	0022	570	0062	770	0102	970	0142	1170	0182	1370	0222
375	0023	575	0063	775	0103	975	0143	1175	0183	1375	0223
380	0024	580	0064	780	0104	980	0144	1180	0184	1380	0224
385	0025	585	0065	785	0105	985	0145	1185	0185	1385	0225
390	0026	590	0066	790	0106	990	0146	1190	0186	1390	0226
395	0027	595	0067	795	0107	995	0147	1195	0187	1395	0227
<b>400</b>	0028	<b>600</b>	0068	<b>800</b>	0108	<b>1000</b>	0148	<b>1200</b>	0188	<b>1400</b>	0228
405	0029	605	0069	805	0109	1005	0149	1205	0189	1405	0229
410	0030	610	0070	810	0110	1010	0150	1210	0190	1410	0230
415	0031	615	0071	815	0111	1015	0151	1215	0191	1415	0231
420	0032	620	0072	820	0112	1020	0152	1220	0192	1420	0232
425	0033	625	0073	825	0113	1025	0153	1225	0193	1425	0233
430	0034	630	0074	830	0114	1030	0154	1230	0194	1430	0234
435	0035	635	0075	835	0115	1035	0155	1235	0195	1435	0235
440	0036	640	0076	840	0116	1040	0156	1240	0196	1440	0236
445	0037	645	0077	845	0117	1045	0157	1245	0197	1445	0237
450	0038	650	0078	850	0118	1050	0158	1250	0198	1450	0238
455	0039	655	0079	855	0119	1055	0159	1255	0199	1455	0239

Tone Code Table											
Freq	Code	Freq	Code	Freq	Code	Freq	Code	Freq	Code	Freq	Code
1460	0240	1660	0280	1860	0320	2060	0360	2260	0400	2460	0440
1465	0241	1665	0281	1865	0321	2065	0361	2265	0401	2465	0441
1470	0242	1670	0282	1870	0322	2070	0362	2270	0402	2470	0442
1475	0243	1675	0283	1875	0323	2075	0363	2275	0403	2475	0443
1480	0244	1680	0284	1880	0324	2080	0364	2280	0404	2480	0444
1485	0245	1685	0285	1885	0325	2085	0365	2285	0405	2485	0445
1490	0246	1690	0286	1890	0326	2090	0366	2290	0406	2490	0446
1495	0247	1695	0287	1895	0327	2095	0367	2295	0407	2495	0447
<b>1500</b>	0248	<b>1700</b>	0288	<b>1900</b>	0328	<b>2100</b>	0368	<b>2300</b>	0408	<b>2500</b>	0448
1505	0249	1705	0289	1905	0329	2105	0369	2305	0409	2505	0449
1510	0250	1710	0290	1910	0330	2110	0370	2310	0410	2510	0450
1515	0251	1715	0291	1915	0331	2115	0371	2315	0411	2515	0451
1520	0252	1720	0292	1920	0332	2120	0372	2320	0412	2520	0452
1525	0253	1725	0293	1925	0333	2125	0373	2325	0413	2525	0453
1530	0254	1730	0294	1930	0334	2130	0374	2330	0414	2530	0454
1535	0255	1735	0295	1935	0335	2135	0375	2335	0415	2535	0455
1540	0256	1740	0296	1940	0336	2140	0376	2340	0416	2540	0456
1545	0257	1745	0297	1945	0337	2145	0377	2345	0417	2545	0457
1550	0258	1750	0298	1950	0338	2150	0378	2350	0418	2550	0458
1555	0259	1755	0299	1955	0339	2155	0379	2355	0419	2555	0459
1560	0260	1760	0300	1960	0340	2160	0380	2360	0420	2560	0460
1565	0261	1765	0301	1965	0341	2165	0381	2365	0421	2565	0461
1570	0262	1770	0302	1970	0342	2170	0382	2370	0422	2570	0462
1575	0263	1775	0303	1975	0343	2175	0383	2375	0423	2575	0463
1580	0264	1780	0304	1980	0344	2180	0384	2380	0424	2580	0464
1585	0265	1785	0305	1985	0345	2185	0385	2385	0425	2585	0465
1590	0266	1790	0306	1990	0346	2190	0386	2390	0426	2590	0466
1595	0267	1795	0307	1995	0347	2195	0387	2395	0427	2595	0467
<b>1600</b>	0268	<b>1800</b>	0308	<b>2000</b>	0348	<b>2200</b>	0388	<b>2400</b>	0428	<b>2600</b>	0468
1605	0269	1805	0309	2005	0349	2205	0389	2405	0429	2605	0469
1610	0270	1810	0310	2010	0350	2210	0390	2410	0430	2610	0470
1615	0271	1815	0311	2015	0351	2215	0391	2415	0431	2615	0471
1620	0272	1820	0312	2020	0352	2220	0392	2420	0432	2620	0472
1625	0273	1825	0313	2025	0353	2225	0393	2425	0433	2625	0473
1630	0274	1830	0314	2030	0354	2230	0394	2430	0434	2630	0474
1635	0275	1835	0315	2035	0355	2235	0395	2435	0435	2635	0475
1640	0276	1840	0316	2040	0356	2240	0396	2440	0436	2640	0476
1645	0277	1845	0317	2045	0357	2245	0397	2445	0437	2645	0477
1650	0278	1850	0318	2050	0358	2250	0398	2450	0438	2650	0478
1655	0279	1855	0319	2055	0359	2255	0399	2455	0439	2655	0479

Tone Code Table											
Freq	Code	Freq	Code	Freq	Code	Freq	Code	Freq	Code	Freq	Code
2660	0480	2720	0492	2780	0504	2840	0516	<b>2900</b>	0528	2960	0540
2665	0481	2725	0493	2785	0505	2845	0517	2905	0529	2965	0541
2670	0482	2730	0494	2790	0506	2850	0518	2910	0530	2970	0542
2675	0483	2735	0495	2795	0507	2855	0519	2915	0531	2975	0543
2680	0484	2740	0496	<b>2800</b>	0508	2860	0520	2920	0532	2980	0544
2685	0485	2745	0497	2805	0509	2865	0521	2925	0533	2985	0545
2690	0486	2750	0498	2810	0510	2870	0522	2930	0534	2990	0546
2695	0487	2755	0499	2815	0511	2875	0523	2935	0535	2995	0547
<b>2700</b>	0488	2760	0500	2820	0512	2880	0524	2940	0536	<b>3000</b>	0548
2705	0489	2765	0501	2825	0513	2885	0525	2945	0537		
2710	0490	2770	0502	2830	0514	2890	0526	2950	0538		
2715	0491	2775	0503	2835	0515	2895	0527	2955	0539		

Plectron Tone Code Table											
Freq	Code	Freq	Code	Freq	Code	Freq	Code	Freq	Code	Freq	Code
282.2	1000	435.3	1010	672.0	1020	1036	1030	1598	1040	2465	1050
294.7	1001	454.6	1011	701.0	1021	1082	1031	1669	1041	2575	1051
307.8	1002	474.8	1012	732.0	1022	1130	1032	1743	1042	2688	1052
321.4	1003	495.8	1013	765.0	1023	1180	1033	1820	1043	2807	1053
335.6	1004	517.8	1014	799.0	1024	1232	1034	1901	1044	2932	1054
350.5	1005	540.7	1015	834.0	1025	1287	1035	1985	1045	3062	1055
366.0	1006	564.7	1016	871.0	1026	1344	1036	2073	1046	3197	1056
382.3	1007	589.7	1017	910.0	1027	1403	1037	2164	1047	3339	1057
399.2	1008	615.8	1018	950.0	1028	1465	1038	2260	1048	3487	1058
416.9	1009	643.0	1019	992.0	1029	1530	1039	2361	1049		

<b>Root Numbers (Commands) by Number</b>		
<b>Number</b>	<b>Page</b>	<b>Description</b>
02	13-2	Control CTCSS Encoder
03	13-5	Select Frequency of CTCSS Encoder
06	6-18, 6-28	Select Frequency of CW and Single-Tone Beeps
08	6-29, 6-52	Select Default Tone and Gap Durations
09	3-15	Set Timer Value (See tables A-41, A-43, A-44)
10	6-11	Set Default Message Level
12	6-19	Select CW Speed
13	6-64	Copy Message (See table page A-39.)
15	6-62	Send Message (See table page A-39.)
16	6-69	Stop Speech In Progress
20	5-9	Create New Macro
21	5-16	Erase Macro
22	5-18	Erase All Macros
23		<i>reserved</i>
24	5-13	Remove Last Command From Macro
25	21-2	Set Clock and Calendar
26	3-18*	Set Event-Triggered Macro (See table page A-36.)
27	5-19	Rename Macro
28	22-2	Create Scheduler Setpoint
29	5-11	Append to Macro
31	*	Select Message (See table page A-39.)
33	5-14	List Macro in CW
34	*	Review Message (See table page A-39.)
35	5-14	List Macro in Speech
37	3-20	Readback
39		<i>Reserved</i>
45	3-14	Set Counter Value (See table page A-49.)
46	5-31	Select and Control Long Names
48	21-4	Adjust Daylight Saving Time
49	20-2	Select and Control User Timers
50	12-10	Select Identifier Tail Message
57	7-5,9-7	Select Path Access Mode (See table page A-45.)
60		<i>reserved</i>
61		<i>reserved</i>
63	3-9, 5-24	Set/Clear Software Switches (See page A-46)
64		<i>reserved</i>
65		<i>reserved</i>
67		<i>reserved</i>
68		<i>reserved</i>
69		<i>reserved</i>
70	15-3	Select Logic Outputs Latched ON



<b>Root Numbers (Commands) by Number</b>		
<b>Number</b>	<b>Page</b>	<b>Description</b>
71	15-3	Select Logic Outputs Latched OFF
72	15-3	Select Logic Outputs Momentary ON
73	15-3	Select Logic Outputs Momentary OFF
76	3-11, 5-21	If-Then-Else
79	11-33	Transmitter Tone Generator
81		<i>reserved</i>
83		<i>reserved</i>
83 1		<i>reserved</i>
83 2		<i>reserved</i>
83 3		<i>reserved</i>
83 10		<i>reserved</i>
84		<i>reserved</i>
85		<i>reserved</i>
86		<i>reserved</i>
87		<i>reserved</i>
88		<i>reserved</i>
90	9-10	Select Path Priority
91		<i>reserved</i>
92	4-3	Assign Control Operator Password
93	4-2	Assign Master Password
94	4-4	Assign Control Operator Privilege level
95	5-29	Miscellaneous Commands
96		<i>reserved</i>
97		<i>reserved</i>
98	5-27	Pause Commands
99		<i>reserved</i>

<b>Event-Triggered Macros By Number</b>		
Assign with (PW) 26 (number) (macro name) *		
Erase with (PW) 26 (number) *		
<b>General Event Macros</b>		
<b>Number</b>	<b>Page</b>	<b>Description</b>
0000	5-28	Power-On Reset Macro
0001	5-31	Battery Good-to-Not-Good Macro
0061	14-2	Logic Input 1 Hi-to-Lo Macro
0062	14-2	Logic Input 1 Lo-to-Hi Macro
0063	14-2	Logic Input 2 Hi-to-Lo Macro
0064	14-2	Logic Input 2 Lo-to-Hi Macro
0065	14-2	Logic Input 3 Hi-to-Lo Macro
0066	14-2	Logic Input 3 Lo-to-Hi Macro
0067	14-2	Logic Input 4 Hi-to-Lo Macro
0068	14-2	Logic Input 4 Lo-to-Hi Macro

<b>Event-Triggered Macros By Number</b>		
Assign with (PW) 26 (number) (macro name) *		
Erase with (PW) 26 (number) *		
<b>Port-Specific Event Macros</b>		
Replace the "r" with the Receiver/DTMF Decoder Number		
Replace the "t" with the Transmitter Number		
<b>Number</b>	<b>Page</b>	<b>Description</b>
0r00	7-36	DTMF Decoder Any Long Tone Macro
0r01	7-30	DTMF Decoder Digit-Decoded Macro
0t02	11-31	Any-Path-Active To TX Macro
0t03	11-31	All-Paths-Inactive To TX Macro
0t04	11-16	TX Dropout Macro
0t05	11-20	PTT Inactive-to-Active Macro
0t06	11-20	PTT Active-to-Inactive Before Unkey Delay Macro
0t07	11-20	PTT Active-to-Inactive After Unkey Delay Macro
0t08	12-7	Initial ID Macro
0t09	12-7	Polite ID Macro
0t10	12-7	Impolite ID Macro
0t11	13-9	CTCSS Encoder Inactive-to-Active Macro
0t12	13-9	CTCSS Encoder Active-to-Inactive Macro
0t13	11-22	TX Start-of-Activity Macro
0t14	11-22	TX End-of-Activity Macro
0r15	10-18	COR Input Hi-to-Lo Macro
0r16	10-18	COR Input Lo-to-Hi Macro
0r17	10-18	CTCSS Input Hi-to-Lo Macro
0r18	10-18	CTCSS Input Lo-to-Hi Macro
0t19	11-9	Courtesy Delay Violation Macro for TX
0t22	9-28	Courtesy Macro for Path RX1-to-TXt
0t23	9-28	Courtesy Macro for Path RX2-to-TXt
0t24	9-28	Courtesy Macro for Path RX3-to-TXt
0t30	9-23	Timeout Macro for Path RX1-to-TXt
0t31	9-23	Timeout Macro for Path RX2-to-TXt
0t32	9-23	Timeout Macro for Path RX3-to-TXt
0t38	9-23	Timeout-End Macro for Path RX1-to-TXt
0t39	9-23	Timeout-End Macro for Path RX2-to-TXt
0t40	9-23	Timeout-End Macro for Path RX3-to-TXt
0t46	9-30	Start-of-Activity Macro for Path RX1-to-TXt
0t47	9-30	Start-of-Activity Macro for Path RX2-to-TXt
0t48	9-30	Start-of-Activity Macro for Path RX3-to-TXt
0t54	9-30	End-of-Activity Macro for Path RX1-to-TXt
0t55	9-30	End-of-Activity Macro for Path RX2-to-TXt
0t56	9-30	End-of-Activity Macro for Path RX3-to-TXt
0r71	10-21	COR Pulse-Triggered Macro for 1 Pulse for RXr
0r72	10-21	COR Pulse-Triggered Macro for 2 Pulses for RXr
0r73	10-21	COR Pulse-Triggered Macro for 3 Pulses for RXr

## Event-Triggered Macros By Number

Assign with (PW) 26 (number) (macro name) \*

Erase with (PW) 26 (number) \*

### Port-Specific Event Macros

Replace the "r" with the Receiver/DTMF Decoder Number

Replace the "t" with the Transmitter Number

Number	Page	Description
0r74	10-21	COR Pulse-Triggered Macro for 4 Pulses for RXr
0r75	10-21	COR Pulse-Triggered Macro for 5 Pulses for RXr
0r76	10-21	COR Pulse-Triggered Macro for 6 Pulses for RXr
0r77	10-21	COR Pulse-Triggered Macro for 7 Pulses for RXr
0r78	10-21	COR Pulse-Triggered Macro for 8 Pulses for RXr
0r79	10-21	COR Pulse-Triggered Macro for 9 Pulses for RXr
0r84	7-34	DTMF Decoder Long Tone 0 Macro
0r85	7-34	DTMF Decoder Long Tone 1 Macro
0r86	7-34	DTMF Decoder Long Tone 1 Macro
0r87	7-34	DTMF Decoder Long Tone 3 Macro
0r88	7-34	DTMF Decoder Long Tone 4 Macro
0r89	7-34	DTMF Decoder Long Tone 5 Macro
0r90	7-34	DTMF Decoder Long Tone 6 Macro
0r91	7-34	DTMF Decoder Long Tone 7 Macro
0r92	7-34	DTMF Decoder Long Tone 8 Macro
0r93	7-34	DTMF Decoder Long Tone 9 Macro
0r94	7-34	DTMF Decoder Long Tone A Macro
0r95	7-34	DTMF Decoder Long Tone B Macro
0r96	7-34	DTMF Decoder Long Tone C Macro
0r97	7-34	DTMF Decoder Long Tone D Macro
0r98	7-34	DTMF Decoder Long Tone * Macro
0r99	7-34	DTMF Decoder Long Tone # Macro

<b>Messages By Number</b>			
Assign with (PW) 31 (number) (message contents) * Review with (PW) 34 (number) * Erase with (PW) 31 (number) *			
Page	Number	Description	Default
<b>General Purpose Messages</b>			
6-65	0000	Warm Reset message	%S-COM 7330 Version <version>+ in speech
7-42	0001	OK message	OK in CW
7-42	0002	Error 1 (Digit Count Error) message	?ERR1 in CW
7-42	0003	Error 2 (Data Error) message	?ERR2 in CW
6-63	0015	User Message #1	None
6-63	0016	User Message #2	None
6-63	0017	User Message #3	None
6-63	0018	User Message #4	None
6-63	0019	User Message #5	None
6-63	0020	User Message #6	None
6-63	0021	User Message #7	None
6-63	0022	User Message #8	None
6-63	0023	User Message #9	None
6-63	0024	User Message #10	None

<b>Messages By Number</b>			
Assign with (PW) 31 (number) (message contents) * Review with (PW) 34 (number) * Erase with (PW) 31 (number) *			
Page	Number	Description	Default
<b>Port-Specific Messages</b>			
Replace the "r" with the Receiver Number Replace the "t" with the Transmitter Number			
9-26	0t00	Path 1t (RX1-TXt) Courtesy Message	Single-Tone Beep
9-26	0t01	Path 2t (RX2-TXt) Courtesy Message	Single-Tone Beep
9-26	0t02	Path 3t (RX3-TXt) Courtesy Message	Single-Tone Beep
9-20	0t03	Path 1t (RX1-TXt) Timeout Message	TO in CW
9-20	0t04	Path 2t (RX2-TXt) Timeout Message	TO in CW
9-20	0t05	Path 3t (RX3-TXt) Timeout Message	TO in CW
9-20	0t06	Path 1t (RX1-TXt) Timeout End Message	TO in CW
9-20	0t07	Path 2t (RX2-TXt) Timeout End Message	TO in CW
9-20	0t08	Path 3t (RX3-TXt) Timeout End Message	TO in CW
12-5	0t09	TX Initial ID Message	ID in CW
12-5	0t10	TX Normal ID Message	ID in CW
12-5	0t11	TX Impolite ID Message	ID in CW
11-13	0t12	TX Dropout Message	None
7-28	0t13	TX DTMF Cover Tone Message	Single-Tone Beep

<b>10ms Timers By Number</b>		
Assign with (PW) 09 (number) (value) * Test with (PW) 76 00 (number) (nonzero macro) (zero macro) *		
<b>General Purpose Timers</b>		
<b>Number</b>	<b>Page</b>	<b>Description</b>
0000	15-5	Logic Output #1 Momentary time
0001	15-5	Logic Output #2 Momentary time
0002	15-5	Logic Output #3 Momentary time
0003	15-5	Logic Output #4 Momentary time
0004	15-5	Logic Output #5 Momentary time
0005	15-5	Logic Output #6 Momentary time
0006	15-5	Logic Output #7 Momentary time
0007	15-5	Logic Output #8 Momentary time
0008	15-5	CTCSS #1 Logic Output Momentary time
0009	15-5	CTCSS #2 Logic Output Momentary time
0010	15-5	CTCSS #3 Logic Output Momentary time

<b>10ms Timers By Number</b>		
Assign with (PW) 09 (number) (value) *		
Test with (PW) 76 00 (number) (nonzero macro) (zero macro) *		
<b>Port-Specific Timers</b>		
Replace the "r" with the Receiver/DTMF Decoder Number		
Replace the "t" with the Transmitter Number		
<b>Number</b>	<b>Page</b>	<b>Description</b>
0t00	11-6	TX Courtesy Delay
0t01	11-10	TX Dropout Delay
0t02	11-17	TX PTT Minimum Unkey Delay
0t03	11-4	TX Turn-On Message Delay Value
0r04	7-8	DTMF Decoder Interdigit Time
0r05	7-21	DTMF Decoder Mute Hang Time, First Digit
0r06	7-21	DTMF Decoder Mute Hang Time, Other Digits
0r07	7-16	DTMF Decoder Disconnect Time
0r08	7-6	DTMF Decoder Anti-Falsing Time
0r09	10-7	COR Anti-Kerchunker Key-Up Delay
0r10	10-25	COR Pulse-Triggered Macro Minimum Pulse Duration
0r11	10-26	COR Pulse-Triggered Macro Maximum Gap Duration
0r12	10-3	COR Filter Delay
0r13	10-5	CTCSS Filter Delay
0t14	6-40	Message Handler Inter-Page Delay Value
0t15	13-7	CTCSS Encoder ON Time Value
0t16	13-8	CTCSS Encoder Reverse Burst Time Value
0r17	10-14	RX Audio Gate Delay Timer Value
0r18	10-12	RX Flutter Filter Timer Value
0t19	7-27	TX DTMF Cover Tone Interval Value



<b>100ms Timers By Number</b>		
Assign with (PW) 09 (number) (value) * Test with (PW) 76 00 (number) (nonzero macro) (zero macro) *		
<b>Port-Specific Timers</b>		
Replace the "r" with the Receiver/DTMF Decoder Number Replace the "t" with the Transmitter Number		
<b>Number</b>	<b>Page</b>	<b>Description</b>
1t00	9-16	Path 1t (RX1-TXt) Timeout Penalty Time Value
1t01	9-16	Path 2t (RX2-TXt) Timeout Penalty Time Value
1t02	9-16	Path 3t (RX3-TXt) Timeout Penalty Time Value
1r03	7-33	DTMF Decoder Long Tone Timer

## 1 Second Timers By Number

Assign with (PW) 09 (number) (value) \*  
 Test with (PW) 76 00 (number) (nonzero macro) (zero macro) \*

### Port-Specific Timers

Replace the "r" with the Receiver Number  
 Replace the "t" with the Transmitter Number

Number	Page	Description
2t00	9-14	Path 1t (RX1-TXt) Timeout Value
2t01	9-14	Path 2t (RX2-TXt) Timeout Value
2t02	9-14	Path 3t (RX3-TXt) Timeout Value
2t03	9-32	Path 1t (RX1-TXt) End-of-Activity Time Value
2t04	9-32	Path 2t (RX2-TXt) End-of-Activity Time Value
2t05	9-32	Path 3t (RX3-TXt) End-of-Activity Time Value
2t06	12-3	TX ID Interval Time Value
2t07	12-4	TX ID Pending Time Value
2t08	11-27	TX Timed Key
2r09	10-10	COR Antikerchunk Re-Arm Delay
2t10	11-23	TX End-of-Activity Time Value
2t11	11-15	TX Dropout Message Time Value

<b>Path Access Mode by Number</b> (PW) 57 (number) (mode) *		
Number	Page	Description
<b>Receiver-to-DTMF Decoder Path Access Mode</b>		
1	7-5	RX1-to-DTMF Decoder #1 Access Mode
2	7-5	RX2-to-DTMF Decoder #2 Access Mode
3	7-5	RX3-to-DTMF Decoder #3 Access Mode
<b>Receiver-to-Transmitter Path Access Mode</b>		
11	9-7	RX1-to-TX1 Access Mode (Path1)
21	9-7	RX2-to-TX1 Access Mode (Path2)
31	9-7	RX3-to-TX1 Access Mode (Path3)
12	9-7	RX1-to-TX2 Access Mode (Path4)
22	9-7	RX2-to-TX2 Access Mode (Path5)
32	9-7	RX3-to-TX2 Access Mode (Path6)
13	9-7	RX1-to-TX3 Access Mode (Path7)
23	9-7	RX2-to-TX3 Access Mode (Path8)
33	9-7	RX3-to-TX3 Access Mode (Path9)

<b>Software Switches By Number</b>		
Assign with (PW) 63 (number) (1/0) *		
Test with (PW) 76 03 (number) (one macro) (zero macro) *		
<b>General Purpose Switches</b>		
Number	Page	Description
0000	4-6	Front Panel Enable
0001	22-2	Scheduler Enable
0002	21-9	Daylight Saving Time (USA) Enable
0003	5-17	Macro Erase Command Returns OK Enable
0004	5-8	Macro-Only Password Decoding Enable
0011	15-6	Logic Output Inversion 1
0012	15-6	Logic Output Inversion 2
0013	15-6	Logic Output Inversion 3
0014	15-6	Logic Output Inversion 4
0015	15-6	Logic Output Inversion 5
0016	15-6	Logic Output Inversion 6
0017	15-6	Logic Output Inversion 7
0018	15-6	Logic Output Inversion 8
0019	15-6	CTCSS Logic Output Inversion 1
0020	15-6	CTCSS Logic Output Inversion 2
0021	15-6	CTCSS Logic Output Inversion 3
0041	16-2	Analog Input 1 Range Select
0042	16-2	Analog Input 2 Range Select
0043	16-2	Analog Input 3 Range Select
0060	5-24	User Switch 60
Thru		Thru
0099	5-24	User Switch 99

**Note:** All undefined software switches are reserved for a future specific use, but may be used in scripts in the current firmware version.

<b>Software Switches By Number</b>		
Assign with (PW) 63 (number) (1/0) *		
Test with (PW) 76 03 (number) (one macro) (zero macro) *		
<b>Port-Specific Switches</b>		
Replace the "r" with the Receiver/DTMF Decoder Number		
Replace the "t" with the Transmitter Number		
Number	Page	Description
0r00	7-38	Command Response Enable
0r01	7-40	OK Command Response Enable
0r02	7-41	Error Command Response Enable
0r03	7-12	Command Execution on End of Transmission
0r04	7-10	Command Execution on Interdigit Timer
0r05	7-16	DTMF Disconnect Timer Enable
0r06	7-32	DTMF Long Tone Enable
0r07	7-14	Command Execution on 4th Digit
0r08	10-16	COR Simulate Req
0r09	10-16	CTCSS Simulate Req
0r10	10-7	Anti-Kerchunker Enable
0r11	10-11	Anti-Kerchunker No Hangtime Mode
0t12	11-25	PTT Enable
0t13	11-29	PTT Untimed Key Request
0t14	12-8	TX Send Initial ID Message
0t15	12-9	TX Send Normal ID Message
0t16	6-30	Message Handler Enable/Disable Beep Gap Default
0t17	13-10	CTCSS Encode Controls CTCSS Logic Out
0t18	7-39	Command Responses In Macros Enable
0r19	10-28	RXr Enable
0t20	13-11	CTCSS Encoder In Anti-Kerchunker No-Hangtime Mode Enable
0t41	9-6	Path 1t (RX1-TXt) Path Enable
0t42	9-6	Path 2t (RX2-TXt) Path Enable
0t43	9-6	Path 3t (RX3-TXt) Path Enable
0t51	7-20	Path 1t (RX1-TXt) DTMF Mute Enable
0t52	7-20	Path 2t (RX2-TXt) DTMF Mute Enable
0t53	7-20	Path 3t (RX3-TXt) DTMF Mute Enable
0t61	9-12	Path 1t (RX1-TXt) Timeout Timer Enable
0t62	9-12	Path 2t (RX2-TXt) Timeout Timer Enable
0t63	9-12	Path 3t (RX3-TXt) Timeout Timer Enable
0t71	9-18	Path 1t (RX1-TXt) Timeout Timer Reset
0t72	9-18	Path 2t (RX2-TXt) Timeout Timer Reset
0t73	9-18	Path 3t (RX3-TXt) Timeout Timer Reset

## Software Switches By Number

Assign with (PW) 63 (number) (1/0) \*  
Test with (PW) 76 03 (number) (one macro) (zero macro) \*

### Port-Specific Switches

Replace the "r" with the Receiver/DTMF Decoder Number  
Replace the "t" with the Transmitter Number

Number	Page	Description
0t81	7-25	Path 1t (RX1-TXt) DTMF Mute Bypass Enable
0t82	7-25	Path 2t (RX2-TXt) DTMF Mute Bypass Enable
0t83	7-25	Path 3t (RX3-TXt) DTMF Mute Bypass Enable
0r90	5-24	User Switch r90
0r91	5-24	User Switch r91
0r92	5-24	User Switch r92
0r93	5-24	User Switch r93
0r94	5-24	User Switch r94
0r95	5-24	User Switch r95
0r96	5-24	User Switch r96
0r97	5-24	User Switch r97
0r98	5-24	User Switch r98
0r99	5-24	User Switch r99

**Note:** All undefined software switches are reserved for a future specific use, but may be used in scripts in the current firmware version.

<b>Counters By Number</b>		
Assign with (PW) 45 (number) (reload value) *		
<b>Port-Specific Counters</b>		
Replace the "r" with the Receiver Number Replace the "t" with the Transmitter Number		
<b>Number</b>	<b>Page</b>	<b>Description</b>
0t00	11-24	TX End-of-Activity Counter
0t01	9-32	Path 1t (RX1-TXt) End-of-Activity Counter
0t02	9-32	Path 2t (RX2-TXt) End-of-Activity Counter
0t03	9-32	Path 3t (RX3-TXt) End-of-Activity Counter

<b>Booleans By Number</b>	
Test with (PW) 76 04 (number) (true macro) (false macro) * See page 5-21.	
<b>Misc. Booleans</b>	
<b>Number</b>	<b>Description When True</b>
0000	<i>reserved</i>
0001	Logic Output #1 Asserted
0002	Logic Output #2 Asserted
0003	Logic Output #3 Asserted
0004	Logic Output #4 Asserted
0005	Logic Output #5 Asserted
0006	Logic Output #6 Asserted
0007	Logic Output #7 Asserted
0008	Logic Output #8 Asserted
0009	CTCSS #1 Logic Output Asserted
0010	CTCSS #2 Logic Output Asserted
0011	CTCSS #3 Logic Output Asserted
0012	Battery Good
0013	Logic Input #1 Asserted
0014	Logic Input #2 Asserted
0015	Logic Input #3 Asserted
0016	Logic Input #4 Asserted
0017	Power up? 1 = Power cycle, 0 = Reset Cycle



<b>Booleans By Number</b>	
Test with (PW) 76 04 (number) (true macro) (false macro) *	
See page 5-21.	
<b>Port-Specific Booleans</b>	
Replace the "r" with the Receiver/DTMF Decoder Number Replace the "t" with the Transmitter Number	
Number	Description When True
0r00	Command is executing on port #r
0t01	Any path active to TXt
0t02	TXt Message Handler Busy
0r03	COR #r Asserted
0r04	CTCSS #r Asserted
0r05	CTCSS #r Encoder Active
0t06	Path 1t (RX1-TXt) Active
0t07	Path 2t (RX2-TXt) Active
0t08	Path 3t (RX3-TXt) Active
0t14	Path 1t (RX1-TXt) Timeout
0t15	Path 2t (RX2-TXt) Timeout
0t16	Path 3t (RX3-TXt) Timeout
0t22	Path 1t (RX1-TXt) Enabled
0t23	Path 2t (RX2-TXt) Enabled
0t24	Path 3t (RX3-TXt) Enabled
0t30	Path 1t (RX1-TXt) Activity Timer/Counter Active
0t31	Path 2t (RX2-TXt) Activity Timer/Counter Active
0t32	Path 3t (RX3-TXt) Activity Timer/Counter Active
0t38	TXt Activity Timer/Counter Active
0t39	TXt PTT Key Line Asserted

<b>Booleans By Number</b>	
Serial Console	
Test with (PW) 76 04 (number) (true macro) (false macro) *	
See page 5-21.	
Number	Description When True
0900	Command is executing on port #9

CTCSS Tone Numbers					
Tone #	Freq Hz	EIA Code	Tone #	Freq Hz	EIA Code
0	33.0	*	32	123.0	3Z
1	35.4	*	33	127.3	3A
2	36.6	*	34	131.8	3B
3	37.9	*	35	136.5	4Z
4	39.6	*	36	141.3	4A
5	44.4	*	37	146.2	4B
6	47.5	*	38	151.4	5Z
7	49.2	*	39	156.7	5A
8	51.2	*	40	159.8	*
9	53.0	*	41	162.2	5B
10	54.9	*	42	165.5	*
11	56.8	*	43	167.9	6Z
12	58.8	*	44	171.3	*
13	63.0	*	45	173.8	6A
14	67.0	XZ	46	177.3	*
15	69.4	*	47	179.9	6B
16	71.9	XA	48	183.5	*
17	74.4	WA	49	186.2	7Z
18	77.0	XB	50	189.9	*
19	79.7	SP	51	192.8	7A
20	82.5	YZ	52	196.6	*
21	85.4	YA	53	199.5	*
22	88.5	YB	54	203.5	M1
23	91.5	ZZ	55	206.5	8Z
24	94.8	ZA	56	210.7	M2
25	97.4	ZB	57	218.1	M3
26	100.0	1Z	58	225.7	M4
27	103.5	1A	59	229.1	9Z
28	107.2	1B	60	233.6	M5
29	110.9	2Z	61	241.8	M6
30	114.8	2A	62	250.3	M7
31	118.8	2B	63	254.1	0Z
			64	150.0	*

\* = not a standard code  
150.0 Hz Used by U.S. Military

<b>Command Quick Reference</b>			
<b>Page</b>	<b>Command Name</b>	<b>Form and Data Digit</b>	<b>Default</b>
<b>3-1</b>	<b>Programming Fundamentals</b>		
3-20	Readback Timer	(PW) 37 00 rpxx * r = timer range 0, 1, 2 p = port 1, 2, 3 xx = timer number 00 thru 99	None
3-20	Readback Software Switch	(PW) 37 03 0pxx * p = port 1, 2, 3 xx = software switch number 00 thru 99	None
3-20	Readback Boolean	(PW) 37 04 0pxx * p = port 1, 2, 3 xx = boolean number 00 thru 99	None
3-20	Readback Scheduler Setpoint	(PW) 37 05 xx * xx = setpoint number 00 thru 99	None
3-20	Readback User Timer	(PW) 37 06 xx * xx = user timer number 00 thru 19	None
3-20	Readback Counter	(PW) 37 07 0pxx * p = port 1, 2, 3 xx = counter number 00 thru 99	None
3-20	Readback Event-Triggered Macro	(PW) 37 08 0pxx * p = port 1, 2, 3 xx = event-triggered macro number 00 thru 99	None
3-20	Readback Path to DTMF Decoder Access Mode	(PW) 37 09 r * r = RX 1, 2, 3	None
3-20	Readback Path to Transmitter Access Mode	(PW) 37 09 rt * r = RX 1, 2, 3 t = TX 1, 2, 3	None
3-20	Readback Analog Input	(PW) 37 10 xxmm * xx = analog input number 01 thru 03 mm = meter face number, 00 = unscaled	None
<b>4-1</b>	<b>Security</b>		
4-2	Assign Master Password	(PW) 93 (new master PW) *	99
4-3	Assign Control Operator Password	(PW) 92 (new control operator PW) *	no password
4-4	Assign Control Operator Privilege Level	(PW) 94 (root number, x) * 0 = master and control operator 1 = master only	all commands accessible
4-5	Assign Control Operator Privilege Level to a Range of Commands	(PW) 94 (first root number, last root number, x) * 0 = master and control operator 1 = master only	all commands accessible
4-6	Enable/Disable Front Panel Display	(PW) 63 0000 x * 0 = OFF (disabled) 1 = ON (enabled)	ON enabled

5-1	Macros		
5-8	Enable/Disable Macro-Only Password Decoding	(PW) 63 0004 x * 0 = OFF (disabled) 1 = ON (enabled)	OFF disabled
5-9	Create New Macro	(PW) 20 (macro name, command) *	no macros
5-11	Append to Macro	(PW) 29 (macro name, command) *	none
5-13	Remove Last Command from Macro	(PW) 24 (macro name) *	none
5-14	List Macro in CW	(PW) 33 (macro name) *	none
5-14	List Macro in Speech	(PW) 35 (macro name) *	none
5-16	Erase Macro	(PW) 21 (macro name) *	none
5-17	Enable/Disable Erase Macro Command Returns OK	(PW) 63 0000 x * 0 = OFF (disabled) 1 = ON (enabled)	OFF disabled
5-18	Erase All Macros	(PW) 22 00 *	none
5-19	Rename Macro	(PW) 27 (old, new) *	none
5-21	If-Then-Else	(PW) 76 (type, value, true macro name, false macro name) * type = 00 (timers), 03 (switch), 04 (Booleans), 05 (Scheduler Setpoint Enable), 06 (User Timers)	none
5-24	Set/Clear User Switch	(PW) 63 (switch number, x) * 0 = OFF (cleared, disabled) 1 = ON (set, enabled)	
5-28	Pause	(PW) 98 0 xxxxx * xxxxx = (0-65535) = 0-655.35 seconds	No pause
5-28	Cancel Pause	(PW) 98 1 x * 1 = DTMF 1 2 = DTMF 2 3 = DTMF 3 9 = Serial	No pause
5-29	Assign Power ON-Triggered Macro	(PW) 26 0000 (macro name) *	none
5-32	Enable/Disable Long Name	(PW) 46 nn 00 x * ww = name number, 00-09 x = 0 = OFF (disabled) x = 1 = ON (enabled)	disabled
5-32	Set Long Name Digits	(PW) 46 ww 01 (name digits) * ww = name number, 00-09 name digits = 0 thru 9, A thru D	none
5-32	Set Long Name Event Macro	(PW) 46 ww 02 (macro name) * ww = name number, 00-09	none
5-32	Set Long Name Port Access	(PW) 46 ww 03 ppp * ww = name number, 00-09 p = port number, 1 thru 3 digits	none
5-35	Assign Battery Warning-Triggered Macro	(PW) 26 0001 (macro name) *	none
5-36	Controller Warm Start	(PW) 95 00 *	none
5-36	Controller Power Cycle	(PW) 95 42 *	none

6-1		Messages	
6-11	Set Default Message Level	(PW) 10 0t0y (level) * t = Tx Number 1, 2, 3 y = Message Type <i>See Message Level Table on page A-2.</i>	
6-18	Select Frequency of CW	(PW) 06 t0 (tone code) * t = Tx Number 1, 2, 3 <i>See Tone Code Table on page A-20.</i>	1500 Hz
6-19	Select CW Speed	(PW) 12 t0 y * t = Tx Number 1, 2, 3 0 = 5 WPM 5 = 17 WPM 1 = 7 WPM 6 = 20 WPM 2 = 10 WPM 7 = 24 WPM 3 = 13 WPM 8 = 30 WPM 4 = 15 WPM 9 = 40 WPM	20 WPM
6-28	Select Frequency of Single-Tone Beep 48	(PW) 06 01 (tone code) * <i>See Tone Code Table on page A-20.</i>	500 Hz
6-28	Select Frequency of Single-Tone Beep 49	(PW) 06 02 (tone code) * <i>See Tone Code Table on page A-20.</i>	750 Hz
6-28	Select Frequency of Single-Tone Beep 50	(PW) 06 03 (tone code) * <i>See Tone Code Table on page A-20.</i>	1000 Hz
6-28	Select Frequency of Single-Tone Beep 51	(PW) 06 04 (tone code) * <i>See Tone Code Table on page A-20.</i>	1250 Hz
6-28	Select Frequency of Single-Tone Beep 52	(PW) 06 05 (tone code) * <i>See Tone Code Table on page A-20.</i>	1500 Hz
6-28	Select Frequency of Single-Tone Beep 53	(PW) 06 06 (tone code) * <i>See Tone Code Table on page A-20.</i>	1750 Hz
6-29	Set Default Beep Duration and Beep Gap Duration	(PW) 08 0x yy * x = port and type yy = Duration 01-99, 10ms to 990ms	Duration = 60ms Gap = 20ms
6-30	Enable/Disable Beep Gap Default	(PW) 63 0t16 x * t = Tx Number 1, 2, 3 0 = OFF (disabled) 1 = ON (enabled)	
6-38	Enable/Disable No-Gap Hang Workaround	(PW) 63 0005 x * 0 = OFF (disabled) 1 = ON (enabled)	ON enabled
6-40	Select Inter-Page Delay	(PW) 09 0t14 yyyy * t = Tx Number 1, 2, 3 yyyy=0-65535 (0-655.35 seconds)	1.0 second
6-52	Set Default DTMF Durations	(PW) 08 xx yy * xx = port and type yy = Duration 01-99, 10ms to 990ms	
6-63	Select User Messages	(PW) 31 xxxx (message) * xxxx = 0015-0024	none

6-63	Review User Messages	(PW) 34 xxxx * xxxx = 0015-0024	none
6-65	Send Message	(PW) 15 (message) *	none
6-67	Copy Message	(PW) xx (src msg, dest msg) *	none
6-68	Select Warm Reset Message	(PW) 31 0000 (message) *	?RES in CW
6-68	Review Warm Reset Message	(PW) 34 0000 *	none
6-69	Stop The Speech Message On This Transmitter	(PW) 16 *	none
6-69	Stop The Speech Message On These Transmitters	(PW) 16 x x x* x = Transmitter Number 1, 2, 3	none
<b>7-1</b>	<b>DTMF Decoder</b>		
7-5	Select RX-to-DTMF Decoder Access Mode	(PW) 57 r y *  r = Rx Number 1, 2, 3 0 = No Access  1 = Carrier 2 = CTCSS 3 = Carrier-AND-CTCSS 4 = Carrier-OR-CTCSS 5 = Anti-CTCSS 6 = Always On	1, Carrier Access
7-7	Select DTMF Decoder Anti-Falsing Timer	(PW) 09 0r08 xxx * r = Port Number 1, 2, 3 xxx=0-500 (0-5.00 seconds)	0 seconds
7-9	Select DTMF Decoder Interdigit Timer	(PW) 09 0r04 xxx * r = Rx Number 1, 2, 3 xxx=2-99 = 0.20-9.90 seconds	5.0 seconds
7-11	Enable/Disable Command Execution on Interdigit Timer	(PW) 63 0r04 x * r = Rx Number 1, 2, 3 0 = OFF (disabled) 1 = ON (enabled)	OFF, disabled
7-13	Enable/Disable End-of-Transmission Command Execution	(PW) 63 0r03 x * r = Rx Number 1, 2, 3 0 = OFF (disabled) 1 = ON (enabled)	OFF, disabled
7-15	Enable/Disable Execute Command on 4th Digit	(PW) 63 0r07 x * r = Rx Number 1, 2, 3 0 = OFF (disabled) 1 = ON (enabled)	OFF, disabled
7-17	Enable/Disable DTMF Decoder Disconnect Timer	(PW) 63 0r05 x * r = Rx Number 1, 2, 3 0 = OFF (disabled) 1 = ON (enabled)	OFF, disabled
7-18	Select DTMF Decoder Disconnect Timer	(PW) 09 0r07 xxxxx * r = Rx Number 1, 2, 3 xxxxx=0-65535 (0-655.35 seconds)	5.0 seconds

7-20	Enable/Disable DTMF Decoder Mute for each Path	(PW) 63 0t5r x * t = Tx Number 1, 2, 3 r = Rx Number 1, 2, 3 0 = OFF (disabled) 1 = ON (enabled)	ON, enabled
7-22	Select DTMF Decoder Mute Hang Time for First Digit, * or #	(PW) 09 0r05 xxx * r = Rx Number 1, 2, 3 xxx=0-200 = 0.00-2.00 seconds	0.50 seconds
7-23	Select DTMF Decoder Mute Hang Time for Other Digits	(PW) 09 0r06 xxx * r = Rx Number 1, 2, 3 xxx=0-200 = 0.00-2.00 seconds	0.50 seconds
7-25	Enable/Disable DTMF Decoder Mute Bypass for each Path	(PW) 63 0t8r x * t = Tx Number 1, 2, 3 r = Rx Number 1, 2, 3 0 = OFF (disabled) 1 = ON (enabled)	ON, enabled
7-27	Select DTMF Cover Tone Interval	(PW) 09 0t19 xxx * t = Tx Number 1, 2, 3 xxx=0-200 = 0.00-2.00 seconds	0.00 seconds disabled
7-28	Select DTMF Cover Tone Message	(PW) 31 0t13 (message) * t = Tx Number 1, 2, 3	Two 587Hz beeps, 20ms long, 60ms spacing
7-30	Select DTMF Decoder Any-Character Macro	(PW) 26 0r01 (macro name) * r = Rx Number 1, 2, 3	none
7-32	Enable/Disable DTMF Long Tones	(PW) 63 0r06 x * r = Rx Number 1, 2, 3 0 = OFF (disabled) 1 = ON (enabled)	OFF, disabled
7-33	Select DTMF Long Tone Timer	(PW) 09 1r03 xxxxx * r = Rx Number 1, 2, 3 xxxxx = 0-65535 (0-6553.5 seconds)	3.0 seconds
7-34	Assign Macro to Long Tone Zero	(PW) 26 0r84 (macro name) * r = Rx Number 1, 2, 3	none
7-34	Assign Macro to Long Tone One	(PW) 26 0r85 (macro name) * r = Rx Number 1, 2, 3	none
7-34	Assign Macro to Long Tone Two	(PW) 26 0r86 (macro name) * r = Rx Number 1, 2, 3	none
7-34	Assign Macro to Long Tone Three	(PW) 26 0r87 (macro name) * r = Rx Number 1, 2, 3	none
7-34	Assign Macro to Long Tone Four	(PW) 26 0r88 (macro name) * r = Rx Number 1, 2, 3	none
7-34	Assign Macro to Long Tone Five	(PW) 26 0r89 (macro name) * r = Rx Number 1, 2, 3	none
7-34	Assign Macro to Long Tone Six	(PW) 26 0r90 (macro name) * r = Rx Number 1, 2, 3	none

7-34	Assign Macro to Long Tone Seven	(PW) 26 0r91 (macro name) * r = Rx Number 1, 2, 3	none
7-34	Assign Macro to Long Tone Eight	(PW) 26 0r92 (macro name) * r = Rx Number 1, 2, 3	none
7-34	Assign Macro to Long Tone Nine	(PW) 26 0r93 (macro name) * r = Rx Number 1, 2, 3	none
7-34	Assign Macro to Long Tone A	(PW) 26 0r94 (macro name) * r = Rx Number 1, 2, 3	none
7-34	Assign Macro to Long Tone B	(PW) 26 0r95 (macro name) * r = Rx Number 1, 2, 3	none
7-34	Assign Macro to Long Tone C	(PW) 26 0r96 (macro name) * r = Rx Number 1, 2, 3	none
7-34	Assign Macro to Long Tone D	(PW) 26 0r97 (macro name) * r = Rx Number 1, 2, 3	none
7-34	Assign Macro to Long Tone Star (*)	(PW) 26 0r98 (macro name) * r = Rx Number 1, 2, 3	none
7-34	Assign Macro to Long Tone Pound (#)	(PW) 26 0r99 (macro name) * r = Rx Number 1, 2, 3	none
7-36	Select DTMF Any Long Tone Macro	(PW) 26 0r00 (macro name) * r = Rx Number 1, 2, 3	none
7-38	Enable/Disable Command Response Messages	(PW) 63 0r00 x * r = Rx Number 1, 2, 3 0 = OFF (disabled) 1 = ON (enabled)	ON, enabled
7-39	Enable/Disable Command Responses In Macros	(PW) 63 0r00 x * r = Rx Number 1, 2, 3 0 = OFF (disabled) 1 = ON (enabled)	ON, enabled
7-40	Enable/Disable OK Command Response Messages	(PW) 63 0r01 x * r = Rx Number 1, 2, 3 0 = OFF (disabled) 1 = ON (enabled)	ON, enabled
7-41	Enable/Disable Error Command Response Messages	(PW) 63 0r02 x * r = Rx Number 1, 2, 3 0 = OFF (disabled) 1 = ON (enabled)	ON, enabled
7-42	Select OK Command Response Message	(PW) 31 0001 (message) *	OK in CW
7-42	Review OK Command Response Message	(PW) 34 0001 *	none
7-42	Select Error 1 Command Response Message	(PW) 31 0002 (message) *	?ERR1 in CW
7-42	Review Error 1 Command Response Message	(PW) 34 0002 *	none



7-42	Select Error 2 Command Response Message	(PW) 31 0003 (message) *	?ERR2 in CW
7-42	Review Error 2 Command Response Message	(PW) 34 0003 *	none
8-1	<b>Serial (RS-232) Commands</b>		
8-8	Reset Console Defaults	(PW) 95 30 *	none
9-1	<b>Paths</b>		
9-6	Enable/Disable Path	(PW) 63 0t4r x * t = Tx Number 1, 2, 3 r = Rx Number 1, 2, 3 0 = OFF (disabled) 1 = ON (enabled)	ON, enabled
9-7	Select Path Access Mode	(PW) 57 rt x * r = Rx Number 1, 2, 3 t = Tx Number 1, 2, 3 0 = No Access 1 = Carrier 2 = CTCSS 3 = Carrier-AND-CTCSS 4 = Carrier-OR-CTCSS 5 = Anti-CTCSS 6 = Always On	1 carrier access
9-10	Select Path Priority	(PW) 90 t r r r * t = Tx Number 1, 2, 3 r = Rx Number 1, 2, 3	Routing Priorities: RX1, RX2, RX3
9-13	Enable/Disable Path Timeout Timer	(PW) 63 0t6r x * t = Tx Number 1, 2, 3 r = Rx Number 1, 2, 3 0 = OFF (disabled) 1 = ON (enabled)	ON, enabled
9-15	Select Path Timeout Timer	(PW) 09 2t0r xxxxx * t = Tx Number 0, 1, 2 r = Rx Number 1, 2, 3 xxxxx=0-65535 (0-65535 seconds)	3.0 minutes (180 seconds)
9-17	Select Path Timeout Penalty Timer	(PW) 09 1t0r xxxxx * t = Tx Number 0, 1, 2 r = Rx Number 1, 2, 3 xxxxx=0-65535 (0-6553.5 seconds)	5.0 seconds
9-19	Reset Path Timeout Timer	(PW) 63 0t7r 1 * t = Tx Number 1, 2, 3 r = Rx Number 1, 2, 3	None
9-21	Select Path RX1-to-TX Timeout Messages	(PW) 31 0t03 (message) * t = Tx Number 1, 2, 3	none
9-21	Select Path RX2-to-TX Timeout Messages	(PW) 31 0t04 (message) * t = Tx Number 1, 2, 3	none

9-21	Select Path RX3-to-TX Timeout Messages	(PW) 31 0t05 (message) * t = Tx Number 1, 2, 3	none
9-21	Review Path RX1-to-TX Timeout Messages	(PW) 34 0t03 * t = Tx Number 1, 2, 3	none
9-21	Review Path RX2-to-TX Timeout Messages	(PW) 34 0t04 * t = Tx Number 1, 2, 3	none
9-21	Review Path RX3-to-TX Timeout Messages	(PW) 34 0t05 * t = Tx Number 1, 2, 3	none
9-22	Select Path RX1-to-TX Timeout End Messages	(PW) 31 0t06 (message) * t = Tx Number 1, 2, 3	none
9-22	Select Path RX2-to-TX Timeout End Messages	(PW) 31 0t07 (message) * t = Tx Number 1, 2, 3	none
9-22	Select Path RX3-to-TX Timeout End Messages	(PW) 31 0t08 (message) * t = Tx Number 1, 2, 3	none
9-22	Review Path RX1-to-TX Timeout End Messages	(PW) 34 0t06 * t = Tx Number 1, 2, 3	none
9-22	Review Path RX2-to-TX Timeout End Messages	(PW) 34 0t07 * t = Tx Number 1, 2, 3	none
9-22	Review Path RX3-to-TX Timeout End Messages	(PW) 34 0t08 * t = Tx Number 1, 2, 3	none
9-24	Select Path RX1-to-TX Timeout Macro	(PW) 26 0t30 (macro name) * t = Tx Number 1, 2, 3	none
9-24	Select Path RX2-to-TX Timeout Macro	(PW) 26 0t31 (macro name) * t = Tx Number 1, 2, 3	none
9-24	Select Path RX3-to-TX Timeout Macro	(PW) 26 0t32 (macro name) * t = Tx Number 1, 2, 3	none
9-25	Select Path RX1-to-TX Timeout End Macro	(PW) 26 0t38 (macro name) * t = Tx Number 1, 2, 3	none
9-25	Select Path RX2-to-TX Timeout End Macro	(PW) 26 0t39 (macro name) * t = Tx Number 1, 2, 3	none
9-25	Select Path RX3-to-TX Timeout End Macro	(PW) 26 0t40 (macro name) * t = Tx Number 1, 2, 3	none
9-27	Select Path RX1-to-TX Courtesy Messages	(PW) 31 0t00 (message) * t = Tx Number 1, 2, 3	none
9-27	Select Path RX2-to-TX Courtesy Messages	(PW) 31 0t01 (message) * t = Tx Number 1, 2, 3	none
9-27	Select Path RX3-to-TX Courtesy Messages	(PW) 31 0t02 (message) * t = Tx Number 1, 2, 3	none
9-27	Review Path RX1-to-TX Courtesy Messages	(PW) 34 0t00 * t = Tx Number 1, 2, 3	none
9-27	Review Path RX2-to-TX Courtesy Messages	(PW) 34 0t01 * t = Tx Number 1, 2, 3	none

9-27	Review Path RX3-to-TX Courtesy Messages	(PW) 34 0t02 * t = Tx Number 1, 2, 3	none
9-29	Select Path RX1-to-TX Courtesy Macro	(PW) 26 0t22 (macro name) * t = Tx Number 1, 2, 3	none
9-29	Select Path RX2-to-TX Courtesy Macro	(PW) 26 0t23 (macro name) * t = Tx Number 1, 2, 3	none
9-29	Select Path RX3-to-TX Courtesy Macro	(PW) 26 0t24 (macro name) * t = Tx Number 1, 2, 3	none
9-31	Select Path RX1-to-TX Start-of-Activity Macro	(PW) 26 0x46 (macro name) * t = Tx Number 1, 2, 3	none
9-31	Select Path RX2-to-TX Start-of-Activity Macro	(PW) 26 0x47 (macro name) * t = Tx Number 1, 2, 3	none
9-31	Select Path RX3-to-TX Start-of-Activity Macro	(PW) 26 0x48 (macro name) * t = Tx Number 1, 2, 3	none
9-31	Select Path RX1-to-TX End-of-Activity Macro	(PW) 26 0x54 (macro name) * t = Tx Number 1, 2, 3	none
9-31	Select Path RX2-to-TX End-of-Activity Macro	(PW) 26 0x55 (macro name) * t = Tx Number 1, 2, 3	none
9-31	Select Path RX3-to-TX End-of-Activity Macro	(PW) 26 0x56 (macro name) * t = Tx Number 1, 2, 3	none
9-32	Select Path RX1-to-TX End-of-Activity Counter	(PW) 45 0t01 xxxxx * xxxxx= <i>event counter</i> 0-65535 0 = each time 1 = every other time ... etc.	0 event count
9-32	Select Path RX2-to-TX End-of-Activity Counter	(PW) 45 0t02 xxxxx * xxxxx = <i>event counter</i> 0-65535 0 = each time 1 = every other time ... etc.	0 event count
9-32	Select Path RX3-to-TX End-of-Activity Counter	(PW) 45 0t03 xxxxx * xxxxx = <i>event counter</i> 0-65535 0 = each time 1 = every other time ... etc.	0 event count
9-32	Select Path RX1-to-TX End-of-Activity Timer	(PW) 09 2t03 xxxxx * t = Tx Number 1, 2, 3 xxxxx=0-65535 (0-65535 seconds)	60 seconds
9-32	Select Path RX2-to-TX End-of-Activity Timer	(PW) 09 2t04 xxxxx * t = Tx Number 1, 2, 3 xxxxx=0-65535 (0-65535 seconds)	60 seconds

9-32	Select Path RX3-to-TX End-of-Activity Timer	(PW) 09 2t05 xxxxx * t = Tx Number 1, 2, 3 xxxxx=0-65535 (0-65535 seconds)	60 seconds
<b>10-1</b>	<b>Receiver</b>		
10-4	Select COR Filter Delay	(PW) 09 0r12 xxxxx * r = Rx Number 1, 2, 3 xxxxx=0-65535 (0-655.35 seconds)	0.00 seconds
10-6	Select CTCSS Filter Delay	(PW) 09 0r13 xxxxx * r = Rx Number 1, 2, 3 xxxxx=0-65535 (0-655.35 seconds)	0.00 seconds
10-8	Enable/Disable Anti-Kerchunker	(PW) 63 0r10 x * r = Rx Number 1, 2, 3 0 = OFF (disabled) 1 = ON (enabled)	OFF, disabled
10-9	Select Anti-Kerchunker Key-Up Delay	(PW) 09 0r09 xxxxx * r = Rx Number 1, 2, 3 xxxxx=0-65535 (0-655.35 seconds)	1.00 seconds
10-10	Select Anti-Kerchunker Re-Arm Delay	(PW) 09 2r09 xxxxx * r = Rx Number 1, 2, 3 xxxxx=0-65535 (0-65535 seconds)	60 seconds
10-11	Enable/Disable Anti-Kerchunker No Hangtime Mode	(PW) 63 0r11 x * r = Rx Number 1, 2, 3 0 = OFF (disabled) 1 = ON (enabled)	OFF disabled
10-13	Select Flutter Filter Timer	(PW) 09 0r18 xxx * r = Rx Number 1, 2, 3 xxx=0-100 (0-1.00 seconds)	0.00 seconds
10-15	Select Audio Gate Delay Timer	(PW) 09 0r17 xxx * r = Rx Number 1, 2, 3 xxx=0-100 (0-1.00 seconds)	0.00 seconds
10-17	Enable/Disable Simulate COR Active	(PW) 63 0r08 x * r = Rx Number 1, 2, 3 0 = OFF (disabled) 1 = ON (enabled)	OFF, disabled
10-17	Enable/Disable Simulate CTCSS Active	(PW) 63 0r09 x * r = Rx Number 1, 2, 3 0 = OFF (disabled) 1 = ON (enabled)	OFF, disabled -
10-19	Assign Macro to COR Input Hi-to-Lo	(PW) 26 0r15 (macro name) * r = Rx Number 1, 2, 3	none
10-19	Assign Macro to COR Input Lo-to-Hi	(PW) 26 0r16 (macro name) * r = Rx Number 1, 2, 3	none
10-20	Assign Macro to CTCSS Input Hi-to-Lo	(PW) 26 0r17 (macro name) * r = Rx Number 1, 2, 3	none

10-20	Assign Macro to CTCSS Input Lo-to-Hi	(PW) 26 0r18 (macro name) * r = Rx Number 1, 2, 3	none
10-23	Select COR Pulse-Triggered Macros	(PW) 26 0r7p (macro name) * r = Rx Number 1, 2, 3 p = Pulse Number 1-9	none
10-25	Select COR Pulse-Triggered Macro Minimum Duration	(PW) 09 0r10 xxxxx * r = Rx Number 1, 2, 3 xxxxx=0-65535 (0-655.35 seconds)	0.25 second
10-26	Select COR Pulse-Triggered Macro Maximum Gap	(PW) 09 0r11 xxxxx * r = Rx Number 1, 2, 3 xxxxx=0-65535 (0-655.35 seconds)	2.00 second
10-28	Enable/Disable Receiver	(PW) 63 0r19 x * r = Rx Number 1, 2, 3 0 = OFF (disabled) 1 = ON (enabled)	ON, enabled
<b>11-1</b>	<b>Transmitter</b>		
11-6	Select Transmitter Turn-On Message Delay	(PW) 09 0t03 xxxxx * t = Tx Number 1, 2, 3 xxxxx=0-65535 (0-655.35 seconds)	0.25 second
11-8	Select Courtesy Delay	(PW) 09 0t00 xxxxx * t = Tx Number 1, 2, 3 xxxxx=0-65535 (0-655.35 seconds)	0.50 second
11-10	Assign Courtesy Delay Violation Macros	(PW) 26 0t19 (macro name) * t = Tx Number 1, 2, 3	none
11-12	Select Dropout Delay	(PW) 09 0t01 xxxxx * t = Tx Number 1, 2, 3 xxxxx=0-65535 (0-655.35 seconds)	3.00 seconds
11-14	Select Dropout Message	(PW) 31 0t12 (message) * t = Tx Number 1, 2, 3	none
11-14	Review Dropout Message	(PW) 34 0t12 * t = Tx Number 1, 2, 3	none
11-15	Select Dropout Message Time	(PW) 09 2t11 xxxxx * t = Tx Number 1, 2, 3 xxxxx=0-65535 (0-65535 seconds)	0 seconds
11-17	Assign Dropout Macro	(PW) 26 0t04 (macro name) * t = Tx Number 1, 2, 3	none
11-19	Select Transmitter PTT Minimum Unkey Delay	(PW) 09 0t02 xxxxx * t = Tx Number 1, 2, 3 xxxxx=0-65535 (0-655.35 seconds)	0.10 second
11-21	Assign Macro to Tx PTT Inactive-to-Active	(PW) 26 0t05 (macro name) * t = Tx Number 1, 2, 3	none
11-21	Assign Macro to Tx PTT Active-to-Inactive Before Unkey Delay	(PW) 26 0t06 (macro name) * t = Tx Number 1, 2, 3	none

11-21	Assign Macro to Tx PTT Active-to-Inactive After Unkey Delay	(PW) 26 0t07 (macro name) * t = Tx Number 1, 2, 3	none
11-23	Select Transmitter End-of-Activity Counter	(PW) 45 0t00 xxxxx * xxxxx = event counter 0-65535 0 = each time 1 = every other time ... etc.	0 event count
11-23	Select Transmitter End-of-Activity Timer	(PW) 09 2t10 xxxxx * t = Tx Number 1, 2, 3 xxxxx=0-65535 (0-65535 seconds)	60 seconds
11-24	Assign Transmitter Start-of-Activity Macro	(PW) 26 0x13 (macro name) * t = Tx Number 1, 2, 3	none
11-24	Assign Transmitter End-of-Activity Macro	(PW) 26 0x14 (macro name) * t = Tx Number 1, 2, 3	none
11-26	Enable/Disable Transmitter PTT	(PW) 63 0t12 x * t = Tx Number 1, 2, 3 0 = OFF (disabled) 1 = ON (enabled)	ON, enabled
11-28	Key Transmitter (Timed)	(PW) 09 2t08 xxxxx * t = Tx Number 1, 2, 3 xxxxx=0-65535 (0-65535 seconds)	No key request
11-30	Key Transmitter (Untimed)	(PW) 63 0t13 x * t = Tx Number 1, 2, 3 0 = Cancel Tx Key 1 = Key	No key request
11-32	Assign Macro to Any-Path-Active to Tx	(PW) 26 0x02 (macro name) * t = Tx Number 1, 2, 3	none
11-32	Assign Macro to All-Paths-Inactive to Tx	(PW) 26 0x03 (macro name) * t = Tx Number 1, 2, 3	none
11-34	Control Transmitter Tone Generator	(PW) 79 t ww xx yyyy *  t = Tx Number 1, 2, 3 ww = mode 0, 1, 2, 3 xx = Message Level yyyy = Tone Code	Mode 0
<b>12-1</b>	<b>Identifier</b>		
12-3	Select ID Message Interval	(PW) 09 2t06 xxxxx * t = Tx Number 1, 2, 3 xxxxx=0-65535 (0-65535 seconds)	3 minutes (180 seconds)
12-4	Select ID Pending Interval	(PW) 09 2t07 xxxxx * t = Tx Number 1, 2, 3 xxxxx=0-65535 (0-65535 seconds)	30 seconds
12-5	Select Initial ID Message for Tx	(PW) 31 0t09 (message) * t = Tx Number 1, 2, 3	ID in CW
12-5	Select Normal ID Message for Tx	(PW) 31 0t10 (message) * t = Tx Number 1, 2, 3	ID in CW

12-5	Select Impolite ID Message for Tx	(PW) 31 0t11 (message) * t = Tx Number 1, 2, 3	ID in CW
12-5	Review Initial ID Message for Tx	(PW) 34 0t09 * t = Tx Number 1, 2, 3	none
12-5	Review Normal ID Message for Tx	(PW) 34 0t10 * t = Tx Number 1, 2, 3	none
12-5	Review Impolite ID Message for Tx	(PW) 34 0t11 * t = Tx Number 1, 2, 3	none
12-7	Select Initial ID Macro for Tx	(PW) 26 0t08 (macro name) * t = Tx Number 1, 2, 3	none
12-7	Select Polite ID Macro for Tx	(PW) 26 0t09 (macro name) * t = Tx Number 1, 2, 3	none
12-7	Select Impolite ID Macro for Tx	(PW) 26 0t10 (macro name) * t = Tx Number 1, 2, 3	none
12-8	Send Initial ID Message for Tx	(PW) 63 0t14 1 * t = Tx Number 1, 2, 3	none
12-9	Send Normal ID Message for Tx	(PW) 63 0t15 1 * t = Tx Number 1, 2, 3	none
12-10	Select Initial ID Tail Message for Tx	(PW) 50 tt xxxx * tt=Tail Number, Tx1=00, Tx2=02, Tx4=04 xxxx=User Message Number 0015-0024	none
12-10	Select Normal ID Tail Message for Tx	(PW) 50 tt xxxx * tt=Tail Number, Tx1=01, Tx2=03, Tx4=05 xxxx=User Message Number 0015-0024	none
<b>13-1</b>	<b>CTCSS Functions</b>		
13-2	Control CTCSS Encoder	(PW) 02 w x y * w = Tx Number 1, 2, 3 x = Mode 0 = off 1 = follow PTT, off before unkey delay  2 = follow PTT 3 = on with PTT, off when timer times out 4 = on with Any-Path-Active, timer after inactive 5 = always on y = Reverse Burst 0 = off 1 = 120-degree 2 = 180 degree	OFF, disabled
13-5	Select Frequency of CTCSS	(PW) 03 x yy * x = Tx Number 1, 2, 3 yy = CTCSS Tone Number (00-63) <i>See TS-64 Programming, page 13-6.</i>	100Hz
13-7	Select CTCSS On Time	(PW) 09 0t15 xxxxx * t = Tx Number 1, 2, 3 xxxxx=0-65535 (0-655.35 seconds)	1.00 second

13-8	Select CTCSS Reverse Burst Time	(PW) 09 0t16 xxxxx * t = Tx Number 1, 2, 3 xxxxx=0-65535 (0-655.35 seconds)	0.15 second
13-9	Select CTCSS Encoder Inactive-to-Active Macro	(PW) 26 0t11 (macro name) *  t = Tx Number 1, 2, 3	none
13-9	Select CTCSS Encoder Active-to-Inactive Macro	(PW) 26 0t12 (macro name) *  t = Tx Number 1, 2, 3	none
13-10	Enable/Disable CTCSS Encoder Controls CTCSS Logic Output	(PW) 63 0t17 x * t = Tx Number 1, 2, 3 0 = OFF (disabled) 1 = ON (enabled)	ON, enabled
13-11	Enable/Disable CTCSS Encoder In Anti-Kerchunker No-Hangtime Mode	(PW) 63 0t20 x * t = Tx Number 1, 2, 3 0 = OFF (disabled) 1 = ON (enabled)	OFF, disabled
<b>14-1</b>	<b>Logic Inputs</b>		
14-2	Assign Macro to Logic Input 1 Hi-to-Lo	(PW) 26 0061 (macro name) *	none
14-2	Assign Macro to Logic Input 1 Lo-to-Hi	(PW) 26 0062 (macro name) *	none
14-2	Assign Macro to Logic Input 2 Hi-to-Lo	(PW) 26 0063 (macro name) *	none
14-2	Assign Macro to Logic Input 2 Lo-to-Hi	(PW) 26 0064 (macro name) *	none
14-2	Assign Macro to Logic Input 3 Hi-to-Lo	(PW) 26 0065 (macro name) *	none
14-2	Assign Macro to Logic Input 3 Lo-to-Hi	(PW) 26 0066 (macro name) *	none
14-2	Assign Macro to Logic Input 4 Hi-to-Lo	(PW) 26 0067 (macro name) *	none
14-2	Assign Macro to Logic Input 4 Lo-to-Hi	(PW) 26 0068 (macro name) *	none
14-2	Assign Macro to COR Input Hi-to-Lo	(PW) 26 0r15 (macro name) *  r = Rx Number 1, 2, 3	none
14-2	Assign Macro to COR Input Lo-to-Hi	(PW) 26 0r16 (macro name) *  r = Rx Number 1, 2, 3	none
14-2	Assign Macro to CTCSS Input Hi-to-Lo	(PW) 26 0r17 (macro name) *  r = Rx Number 1, 2, 3	none
14-2	Assign Macro to CTCSS Input Lo-to-Hi	(PW) 26 0r18 (macro name) *  r = Rx Number 1, 2, 3	none



15-1 Logic Outputs			
15-3	Select Logic Outputs Latched ON	(PW) 70 (list of outputs 01-11) *	all OFF disabled
15-3	Select Logic Outputs Latched OFF	(PW) 71 (list of outputs 01-11) *	all OFF disabled
15-3	Select Logic Outputs Momentary ON	(PW) 72 (list of outputs 01-11) *	all OFF disabled
15-3	Select Logic Outputs Momentary OFF	(PW) 73 (list of outputs 01-11) *	all OFF disabled
15-5	Select Logic Output Momentary Timer	(PW) 09 00ww xxxxx * ww = Logic Output 1-11 (00-10) xxxxx = 0-65535 (0-655.35 seconds)	0.50 second
15-6	Select Logic Output Inversion	(PW) 63 00ww x * ww = Logic Output 1-11 (11-21) 0 = normal 1 = inverted	Normal
20-1 User Timers			
20-2	Select Timeout Value	(PW) 49 ww 03 xxxxx * ww = timer number, 00-09 xxxxx = timeout (1-65535) = 0.1-6553.5 seconds	1.0 second
20-3	Assign Timer Event Macro	(PW) 49 ww 02 (macro name)* ww = timer number, 00-09	none
20-3	Unassign Timer Event Macro	(PW) 49 ww 02 * ww = timer number, 00-09	none
20-4	Stop Timer	(PW) 49 ww 00 * ww = timer number, 00-09	none
20-5	Start/Restart Timer (Retriggerable)	(PW) 49 ww 01 * ww = timer number, 00-09	none
20-6	Start Timer (One-Shot)	(PW) 49 ww 04 * ww = timer number, 00-09	none
21-1 Clock and Calendar			
21-2	Set Clock and Calendar	(PW) 25 (year, month, day-of-month, day-of-week, hour, minute, second) * year = 00-99 month = 01-12 (Jan is 01) day-of-month = 01-31 day-of-week = 0-6 (Sun is 0) hour = 00-23 minute = 00-59 second = 00-59 (optional)	00:00:00, Sun, Jan 1, 2006
21-4	Adjust Daylight Savings Time	(PW) 48 x * 0 = fall back (subtract 1 from hours) 1 = spring ahead (add 1 to hours) 2 = fall back (subtract 1 from hours, inhibited for 61 minutes.)	none
21-6	Reset Clock Seconds	(PW) 48 3 *	none

21-7	Add Clock Seconds	(PW) 48 4 (seconds) * seconds = 01-30	none
21-7	Subtract Clock Seconds	(PW) 48 5 (seconds) * seconds = 01-30	none
21-7	Subtract Clock Seconds, Inhibited for 2 Minutes	(PW) 48 6 (seconds) * seconds = 01-30 (Inhibited for 2 minutes)	none
21-9	Enable/Disable Automatic Daylight Saving Time Adjustment	(PW) 63 0002 x * 0 = disabled 1 = enabled	disabled
<b>22-1</b>	<b>Scheduler</b>		
22-2	Enable/Disable Scheduler	(PW) 63 0001 x * 0 = OFF (disabled) 1 = ON (enabled)	ON Enabled
22-3	Create Setpoint	(PW) 28 (setpoint, macro, month, day, hour, minute) * setpoint = 00-99, 2 digits macro = 4 digits month = 01-12 or 99, 2 digits day = 01-75 or 99, 2 digits <i>See Day Code Table page A-19</i> hour = 00-23 or 99, 2 digits minute = 00-59 or 99, 2 digits (Note: 99 is the <i>wild card</i> )	no setpoints
22-7	Enable/Disable One Setpoint	(PW) 28 (setpoint) x * setpoint = 00-99, 2 digits 0 = OFF (disabled) 1 = ON (enabled)	ON Enabled
22-7	Enable/Disable Range of Setpoints	(PW) 28 (first setpoint) (last setpoint) x * setpoint = 00-99, 2 digits 0 = OFF (disabled) 1 = ON (enabled)	ON Enabled
22-8	Delete One Setpoint	(PW) 28 (setpoint) * setpoint = 00-99, 2 digits	none
22-8	Delete Range of Setpoints	(PW) 28 (first setpoint) (last setpoint) * setpoint = 00-99, 2 digits	none

---

# Appendix B

# Installation

---

## Introduction

The information in this section will help you to properly interface the 7330 to your repeater system. It describes the 7330's LED indicators, inputs, outputs, jumpers, and potentiometers, and suggests simple measurements to test the results.

You will find that the 7330's flexible audio and logic interfaces make it *installer-friendly*, and that minimum external hardware is needed to complete the installation.

---

**Note:** To disable transmitters, mute DTMF digits, etc., the 7330 must have full control over all PTT and audio circuits. When installing the 7330, remove pre-existing connections that bypass its inputs and outputs.

---

## Static Warning!

Electrostatic Discharge (ESD) can damage sensitive integrated circuits in the controller. ESD can occur when you touch internal circuitry, adjust pots, move jumpers, and connect or disconnect test equipment. Avoid touching circuit components unless you are properly grounded and have eliminated the possibility of static discharge.

You can protect the controller by wearing a static-discharge wristband and using an anti-static mat to cover your work surface. Alternatively, you can ground yourself to discharge any static charge by touching the controller's grounded cabinet before touching its connectors or internal circuitry.

To further protect the controller, place it in its antistatic bag when storing and transporting.

Repair of damage that is found to be caused by electrostatic discharge is not covered under warranty.

## Front Panel LEDs

In the following sections, the Front Panel LEDs will be referenced for each port:

- COR . lights when the COR input for this port is active.
- CTCSS . lights when the CTCSS input for this port is active.
- DTMF . lights when the DTMF decoder is decoding a digit for this port.
- PTT . lights when the transmitter PTT for this port is active.
- ENC . lights when the CTCSS encoder for this port is active.

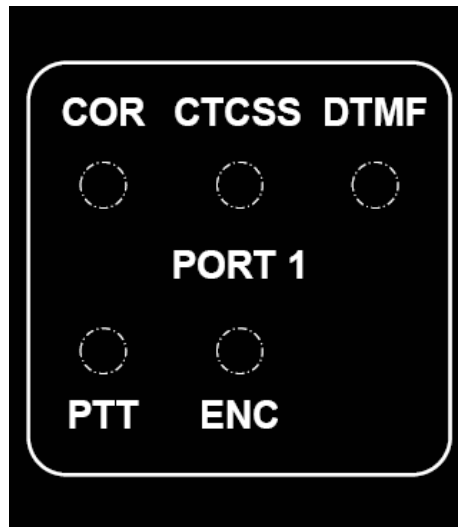

## Cables

You will need to prepare several cables for the 7330 controller:

- A DC power cable
- A radio cable for each port
- An auxiliary cable for logic inputs, logic outputs, and A/D converter inputs

---

**Note:** To avoid crosstalk, use individually-shielded wires (not single-shield multiconductor cable) for receiver audio, transmitter audio, and CTCSS encode audio. Keep the wiring short, especially for high impedance circuits such as discriminator outputs and microphone inputs. The high capacitance of a long shielded cable can cause high frequencies to be rolled off.

---

The following section explains how to properly connect the 7330 to your equipment.

## Jumpers – Storing Them

A small bag of jumpers has been included with your controller to configure each of the interfaces. It's important that you don't lose these. You will likely need some of them in the pages that follow for your initial configuration, and may need most or all of the rest in the future.

There's a couple ways to store them.

- You can tape the bag inside the lid of the controller so they are always available when you need them.
- You could also install them at the location that you'll eventually need them, but push them onto only a single pin of the jumper location. This leaves the connection open but keeps the jumper available for future use.

See the color-coded board silkscreen on page B-18 for the locations that jumpers will be used and the table on page B-23 for how they are used. The installation instructions that follow will specify which jumpers to use for each interface on each port.

## Receiver COR

Since the controller needs to know when carrier signals are present, you'll need to connect each receiver's COR (Carrier Operated Relay) or COS (Carrier Operated Switch) output to pin 2 of its 7330 port connector.

(COR or COS is a logical (high/low) output driven by the receiver's noise-operated squelch circuit. The signal from a channel busy+LED indicator will also work.)

For now, it doesn't matter whether the COR signal is low-active or high-active. You'll be using the controller's sense-reversal jumpers to select the correct action.

The following explanation of the controller's COR input circuit will help you configure it properly.

Each COR input circuit consists of a 4.7K pullup resistor (that can be connected or disconnected with a push-on jumper), two voltage divider resistors, and an NPN transistor.

Installing the jumper connects the 4.7K pullup resistor between the COR input and the controller's +5V supply. This resistor supplies input current to the NPN transistor when the receiver's COR driver is an open-collector transistor (or a relay contact to ground) and is in the OFF state.

The pullup is not needed if the driver is a voltage source such as a logic gate, op amp, or squelch IC. In fact, certain ICs won't pull the COR input down far enough if the pullup is present. If that happens, remove the jumper.

The pullup resistor jumpers are located directly behind their port connectors and are labeled COR1 PULLUP, COR2 PULLUP, and COR3 PULLUP.

The purpose of the voltage divider is to raise the input threshold from about 0.7 V to about 2 V. Without the divider, COR drivers with high saturation voltages (such as Darlington transistors) would exceed the threshold and look logically HIGH all of the time.

### To check your installation:

- Make the COR connection. (If your receiver's COR output is a pair of relay contacts, use one for COR and ground the other.)
- With the controller and the receiver powered up, measure the voltage at the controller's COR input pin.
- The voltage should swing above and below 2 V as an incoming carrier is applied and removed.
- Locate J31, a 2x8-pin header with positions for six inversion jumpers (the jumpers we're interested in are COR1, COR2, and COR3). (See Board Silkscreen on page B-18.) If applying a carrier to the receiver causes the front panel COR LED to light, the jumper is in the correct position. If the carrier and COR LED act opposite each other, move the jumper to open or short the pins as needed. (Installing the jumper configures the COR input to be high-active; removing the jumper configures the input to be low-active.)

---

## Receiver CTCSS

CTCSS, or Continuous Tone-Controlled Squelch System, is a convenient problem solver for repeaters in crowded bands. The controller also allows CTCSS to be used to qualify DTMF commands to increase security.

Well-known tradenames for CTCSS include *PL* or *Private Line* (Motorola), *Channel Guard* (General Electric), and *Call Guard* (Johnson).

If your repeater doesn't have a built-in CTCSS decoder, you can install an aftermarket unit. The TS-64 from Communications Specialists, Inc., Orange, CA, 1-800-854-0547, <http://www.com-spec.com>, is a good example. The TS-64 is crystal-controlled for stability and decodes one of 64 CTCSS tone frequencies. If you install an aftermarket CTCSS decoder in your receiver, be sure to follow the instructions provided by the manufacturer. And we recommend that you install it in the receiver chassis to minimize noise pickup and protection from the high RF levels generally present around repeaters.

Regardless of the type of CTCSS decoder, the controller needs to know when CTCSS is present. Connect each CTCSS decoder output to pin 3 of its 7330 port connector.

The decoder's detect/no detect output driver is probably an open-collector transistor. For now, it doesn't matter whether the output signal is low-active or high-active. You'll be using the controller's sense-reversal jumpers to select the correct action.

The design of the controller's CTCSS decoder input circuit is exactly the same as the COR input circuit, so we won't repeat the hardware description.

The pullup resistor jumpers are located directly behind their port connectors and are labeled CTCSS1 PULLUP, CTCSS2 PULLUP, and CTCSS3 PULLUP.

### To check your installation:

- Make the CTCSS decoder connection.
- With the controller, receiver, and CTCSS decoder powered up, measure the voltage at the controller's RXn CTCSS input pin.
- The voltage should swing above and below 2 V as an incoming CTCSS signal is applied and removed.
- Locate J31, a 2x8-pin header with positions for eight inversion jumpers (the jumpers we're interested in are CTCSS1, CTCSS2, and CTCSS3). (See Board Silkscreen on page B-18.) If applying a CTCSS tone to the receiver causes the front panel CTCSS LED to light, the jumper is in the correct position. If the tone and CTCSS LED act opposite each other, install or remove the jumper as needed. (Installing the jumper configures the CTCSS input to be high-active; removing the jumper configures the input to be low-active.)

## Transmitter PTT

Each transmitter has a logical (high/low) input called PTT (Push-To-Talk). The transmitter will key (transmit) when its PTT is active. Connect each transmitter's PTT input to pin 4 of its 7330 port connector.

For now, it doesn't matter whether the PTT signal needs to be low-active or high-active. You'll be using the controller's sense-reversal jumpers to select the correct action.

The following explanation of the controller's PTT output circuit will help you configure it properly.

The PTT driver, U43, is a TPIC6B596N 8-bit shift register with open-drain power MOSFET outputs. It's a 20-pin DIP and is socketed for easy replacement.

Each PTT output looks like a set of relay contacts to ground. Each output can sink 150 mA when ON and withstand 45 V when OFF. Its low ON resistance (5 ohms) allows it to control a wide range of PTT circuit types, from TTL logic to large DC relay coils. (Note that when driving a relay coil, connect a diode across the coil in the non-conducting direction to protect the logic output.)

Some transmitters, including models made by Hamtronics, Maggiore, and RCA (500-and 700-series), have PTT inputs that cannot be keyed by an open-drain driver. They are keyed and unkeyed by applying and removing a positive voltage source into their PTT inputs. The current requirement can be substantial. A simple outboard circuit, described as follows, can be placed between the controller's PTT output and the transmitter's PTT input to satisfy these requirements:

- Connect a large PNP transistor so that its emitter goes to the transmitter's +12 V supply, its collector goes to the transmitter's PTT input, and its base goes to the controller's PTT output *through a 2K resistor* (important).
- Connect a 4.7K resistor across the PNP transistor's base and emitter.
- If the transmitter draws little PTT current (500 mA or less), you can use a 2N2904.
- If the transmitter PTT draws 1 A or less, use a TIP30.
- When using this outboard circuit, set the PTT for active-low operation.

### To check your installation:

- Make the PTT connection.
- Locate J33, a 2x6-pin header with positions for six inversion jumpers (the jumpers we're interested in are PTT1, PTT2, and PTT3). (See Board Silkscreen on page B-18.) If the jumper is in the correct position, the PTT LED is lit while the transmitter is keyed. If the transmitter and PTT LED act opposite each other, install or remove the jumper as needed. (Installing the jumper configures the PTT output to be high-active; removing the jumper configures the output to be low-active.)



## Setting Audio Levels

To get the best sound from your repeater, it's important that you set the audio levels properly. Always work left to right across the drawing below adjusting jumpers and levels. (See setup details on the following pages.)

Start with setting the deemphasis jumper, then adjust the receiver level pot (and level jumper, if required) for the proper level of flat audio at the receiver audio test point. This setting is very important for two reasons. First, it ensures that the DTMF decoder will properly decode DTMF digits. And second, it ensures that the Speech and Tone Generator can be adjusted across the full audio range. You will need to repeat these steps for each receiver.

Complete the setup by adjusting the transmitter level pot (and level jumper, if required) while monitoring the deviation on a service monitor. Repeat this setup for each transmitter.

Step by step instructions start on the next page.

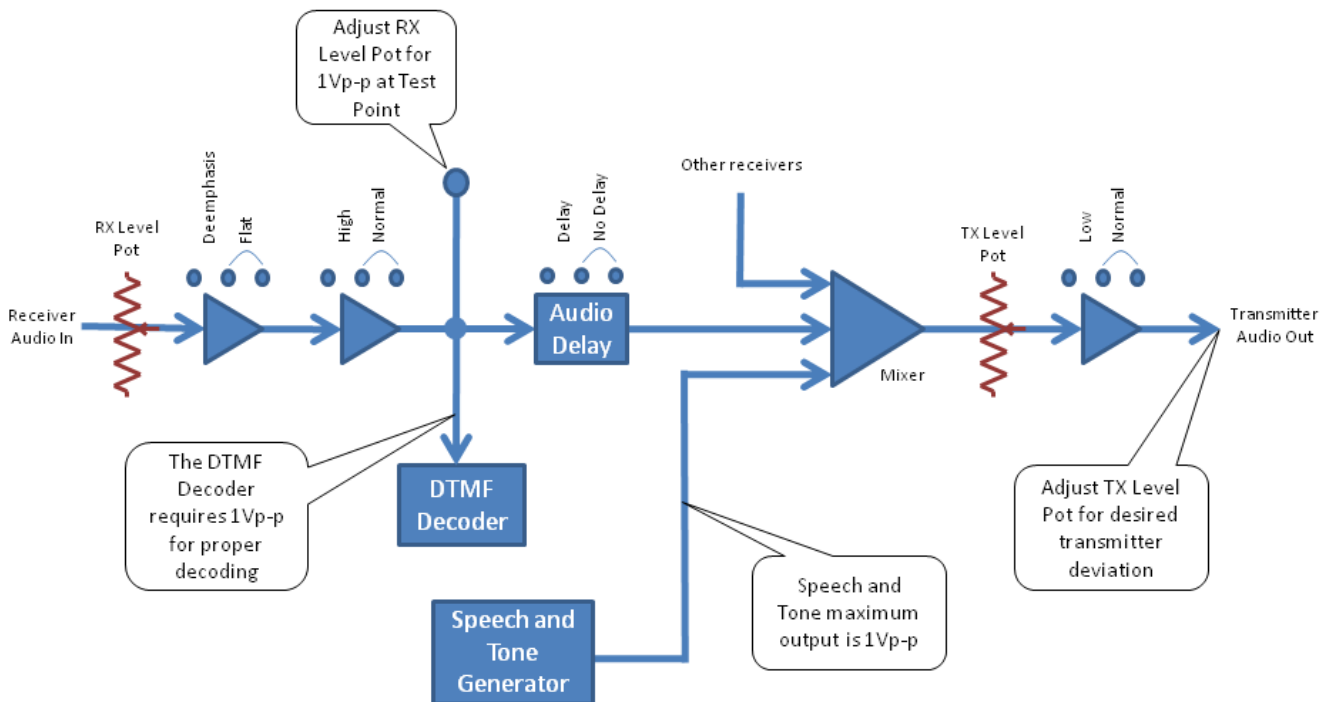

## Receiver Audio

Since the controller needs audio from the receivers, you will need to connect an audio point in each receiver to pin 1 of its 7330 port connector.

The following explanation of the controller's Receiver Audio Input circuit will help you configure it properly.

Each of the three receiver audio input circuits is identical and consists of an input level pot, a first op amp stage with a response jumper arrangement, and a second op amp stage with a gain jumper arrangement.

The level pots are labeled RX1 for receiver #1, RX2 for receiver #2, and RX3 for receiver #3. The pot is connected across the audio input and sets the level going into the first op amp stage. The impedance at the audio input pin varies with the position of this pot and is 25K ohms or greater.

Locate the 2x6 headers used for receiver audio jumpers (see Board Silkscreen on page B-18):

Receiver	2x6 Jumper Block
1	J10
2	J11
3	J3

The first jumper is labeled DE-EMP and the second jumper is labeled FLAT.

If you are using discriminator (pre-emphasized) audio, remove the FLAT jumper and install the DE-EMP jumper to configure the first stage for de-emphasis and extra gain. The corner frequency is approximately 200 Hz.

If you are using flat (de-emphasized) audio, remove the DE-EMP jumper and install the FLAT jumper to configure the first stage as a unity gain buffer.

The third jumper is labeled HIGH and the fourth jumper is labeled NORM.

Remove the NORM jumper and install the HIGH jumper for a gain of 6.3. Remove the HIGH jumper and install a NORM jumper for a gain of 2. (Note that the audio going into the first stage is halved if the pot is in the 50% position. The gain in the second stage, then, results in an overall gain of 1 (NORM) or 3.1 (HIGH) when the pot is set at 50%.)

The reason for having separate stages for response and gain is to allow easier modifications for special applications when necessary.

A good source of de-emphasized audio in some receivers is the high or low end of the volume control potentiometer. This point often comes from the output of the receiver's first audio preamplifier stage (usually directly after the discriminator). Some receivers have this point already de-emphasized, others do not. The FLAT/DE-EMP jumpers in the 7330 supports both types.

---

**Note:** Don't use the receiver's volume control wiper as the audio source because accidental movement of the control will affect the repeat level. Avoid using speaker audio because the distortion is higher at the speaker than at earlier stages.

---

Digital audio delay is built into all three receiver interfaces. To add audio delay, locate the 2x6 headers again. The fifth jumper is labeled DLY and the sixth jumper is labeled NODLY.

If you want audio delay, move the NODLY jumper to the DLY jumper position. The amount of delay is adjustable from about 30 to 250 mS via the DELAY1 (RX1), DELAY2 (RX2) and DELAY3 (RX3) pots.

If you don't want audio delay, move the DLY jumper to the NODLY jumper position.

---

**Caution:** When setting the audio delay pot, do not set the delay all the way to minimum. This can cause the audio delay circuitry to malfunction. All that is required is to increase the delay slightly from the minimum setting so that the malfunction will not occur.

---

### To check your installation:

Feed the receiver with a fully-deviated 1 KHz sine wave tone from a service monitor.

Adjust the receive level pot in the 7330 (and move the gain jumper, if necessary) so that an audio level of 1 V peak-to-peak (354 mV rms) is seen at test point TP9 (for receiver #1), TP10 (for receiver #2), and TP11 (for receiver #3). An oscilloscope is the best instrument for this measurement.

Receiver	Test Point	Adjust Pot	Set To
1	TP9	RX1	1 V p-p (354 mV rms)
2	TP10	RX2	
3	TP11	RX3	

We recommend 1 V p-p because it matches the on-board tone and digital audio generators and is the best level for driving the DTMF decoders.

---

**Note:** It's important that flat audio is delivered to the test point for each receiver. The flat audio is required for proper DTMF decoding and level setting throughout the controller.

---

## Transmitter Audio

Since the controller needs to send flat audio to the transmitters, you'll need to connect an audio input in each transmitter to pin 5 of its 7330 port connector.

The following explanation of the controller's Transmit Audio Output circuit will help you configure it properly.

Each of the three transmitter audio output circuits is identical and consists of an audio gating circuit, an op amp summing amplifier (audio mixer), an audio level pot, and a driver stage with an attenuator jumper arrangement.

The audio gates connect the flat audio from one or more receivers to the summing amplifier. The summing amplifier output can be measured at TP25 (for transmitter #1), TP26 (for transmitter #2), and TP31 (for transmitter #3).

Each summing amplifier feeds a level pot. The three pots are labeled TX1, TX2, and TX3.

The pot, in turn, feeds a driver stage. The driver stage has an output impedance of 600 ohms and is AC coupled to the transmitter audio output pin with a 10 uF nonpolarized capacitor.

The audio output level depends upon the load impedance presented to the transmitter audio output and the position of the driver stage's attenuation jumper. Attenuation is needed if you are driving a transmitter with a sensitive audio input, such as a microphone input.

Locate the 3-pin headers near the transmitter level pots (see Board Silkscreen on page B-18):

Transmitter	Jumper
1	J34
2	J35
3	J36

Each header has two jumper positions, LOW and NORM.

With the jumper in the NORM position:

- If the controller is driving a load of 10K ohms or greater, the output level can be adjusted from zero to 2 V p-p (700 mV rms).
- If the controller is driving a 600-ohm load, the output level can be adjusted from zero to 1 V p-p (350 mV rms).

With the jumper in the LOW position:

- If the controller is driving a load of 10K ohms or greater, the output level can be adjusted from zero to 0.5 V p-p (175 mV rms).
- If the controller is driving a 600-ohm load, the output level can be adjusted from zero to 0.25 V p-p (88 mV rms).

The 7330 provides very good audio quality; see the Specifications chapter for figures.

**To check your installation:**

Feed the receiver pathed to the transmitter you want to adjust with a fully-deviated 1 KHz sine wave tone from a service monitor. Verify that the transmitter is being keyed by that receiver.

Adjust the transmit level pot in the 7330 (and move the gain jumper, if necessary) so for a fully deviated signal on the service monitor monitoring the transmitter output.

Transmitter	Adjust Pot	Set To
1	TX1	Fully deviated
2	TX2	
3	TX3	

For example, for NBFM, feeding a receiver with a 1 kHz tone deviated at 4.5 kHz should be transmitted at 4.5 kHz deviation. Note that different types of devices attached to the controller ports may require different levels, e.g., IRLP or P25.

---

**Note:** The controller feeds flat audio to the transmitter audio input. The transmitter must provide the preemphasis to the transmitted signal.

---

## CTCSS Encoder

The 7330 has a built-in CTCSS encoder for each of the three transmitter ports. The encoder is designed to generate a well-filtered sine wave signal to the modulator input of your transmitter. You can command a phase reversal of 120 degrees, 180 degrees, or none. For minimal audio distortion, the phase reversal takes place at the zero-crossing point on the sine wave.

If you want to use the 7330's built-in CTCSS encoder, connect the transmitter's modulator audio input to pin 8 of its 7330 port connector.

---

**Note:** You cannot use the microphone input or other processed audio input of your transmitter to feed the CTCSS Encoder's tone. You must use the modulator input of your transmitter provided for this purpose.

---

If you want to use an outboard encoder, the 7330 can still assist you. Pin 8 of each port connector can be driven by an extra logic output instead of the encoder.

You'll find three three-pin headers, J37 (for transmitter #1), J38 (for transmitter #2), and J39 (for transmitter #3), near the receiver #1 audio pot. (See Board Silkscreen on page B-18.) Each header has two jumper positions, LOGIC and CTCSS. With the push-on jumper in the LOGIC position, an extra logic output (separate from the eight general-purpose logic outputs) drives pin 8. With the jumper in the CTCSS position, the internal CTCSS encoder drives pin 8. Each of these three extra logic outputs has the same specifications as the PTT and general-purpose logic outputs.

The following explanation of the controller's CTCSS Encoder circuit will help you configure it properly.

Each of the three encoder circuits is identical and consists of a DAC (digital-to-analog converter), a 5th-order lowpass filter, a level pot, and a driver stage.

The filtered CTCSS tone can be measured ahead of the level pot at TP18 (encoder #1), TP20 (encoder #2), and TP15 (encoder #3).

The level pots are labeled CTCSS1, CTCSS2, and CTCSS3.

Transmitter	Adjust Pot	Set To
1	CTCSS1	600 Hz deviation
2	CTCSS2	
3	CTCSS3	

The driver stage has an output impedance of 2K ohms and is AC coupled to the CTCSS audio output pin with a 10 uF nonpolarized capacitor.

The audio output level when driving a high-impedance load (>20K) is zero to 2 V p-p (700 mV rms).

## Tone/Speech Levels

The CW, tone, and speech levels can be set by command. You can set them when the controller is installed or you can set them later. See the *Message Levels* section on page 6-10 for details.

## Control Receiver

A control receiver is a wise addition to your site because it allows you to control your site on a frequency other than a repeater input.

The connections for a control receiver are the same as for other types of receivers and have been described previously.

## DC Power Requirements

The 7330 operates from +9 to +36 volts DC. It consumes about 1.7 watts when all front panel LEDs are on, and about 1.5 watts when all LEDs are off.

The 7330's power consumption is relatively constant over the supply voltage range. You can find the current drain at a given supply voltage by dividing 1.7 watts by the supply voltage. For example, the current drain from a 13.8 V supply is  $1.7 \text{ W}/13.8 \text{ V} = 123 \text{ mA}$ .

The graph below assumes a power consumption of 1.7 watts and provides a quick estimate of current drain for various supply voltages.

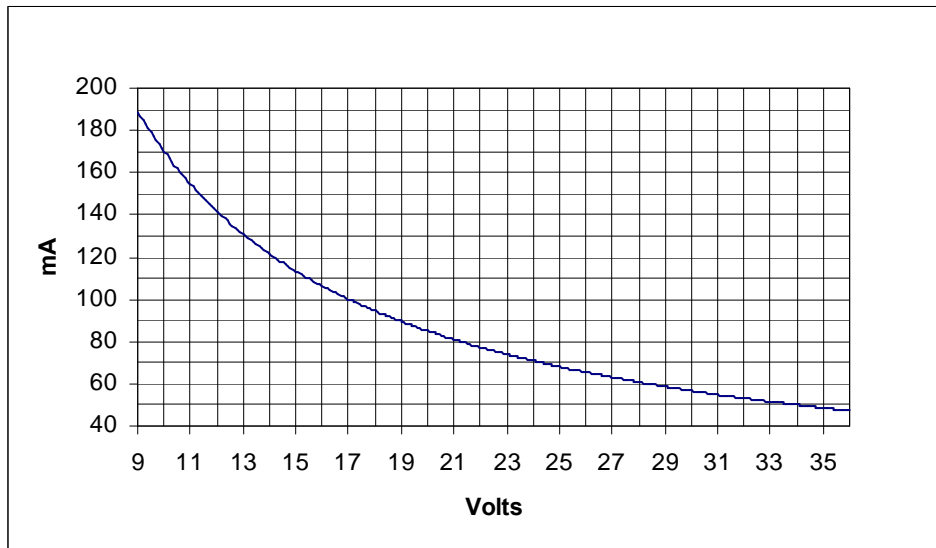

The power connector is a locking Phoenix screw terminal plug (one supplied). The (+) and (-) connections are silkscreened on the rear of the chassis. The controller has an internal series diode for reverse polarity protection.

---

**Note:** if you want to build a spare power cord, the cable end power connector is a Phoenix part number 1757019 or Tyco part number 796634-2.

The Digi-Key part number for the Phoenix part is 277-1011-ND; the Mouser part number is 651-1757019.

---

Don't use a very small power supply with a low current limit. The supply must provide capacitor inrush current at power on.

If your site has a backup power source, be sure the controller is connected to it so you'll have control during power outages.

The 7330 has nonvolatile memory and does not need external power to maintain stored data and its active configuration.

---



## Logic Inputs

The 7330 can monitor four logical (ON/OFF) devices at the repeater site with its logic inputs. Any of the three receiver COR inputs and the three CTCSS decoder inputs may be used as additional logic inputs.

The design of the Logic Input Circuit is exactly the same as the COR input circuit, so we won't repeat its hardware details here.

The pullup resistor jumpers are located on a header, J4, near the 25-pin D-sub connector and are labeled IN1 through IN4. (See Board Silkscreen on page B-18.)

The controller can sense a low-to-high transition and a high-to-low transition on each logic input. Since they detect both edges, logic inputs don't require inversion jumpers.

Logic inputs are very handy for informing the controller when some external condition has changed. Examples include detection of high water, high SWR, AC (mains) power failure, intrusion, and so on. Since the controller will execute a macro command upon sensing a change, the owner can choose the action that will be taken. (This is a big improvement over controllers that take a single fixed action when an input is tripped, such as appending an alarm CW message to the tail.)

The states of the logic inputs are shown on the front panel LEDs:

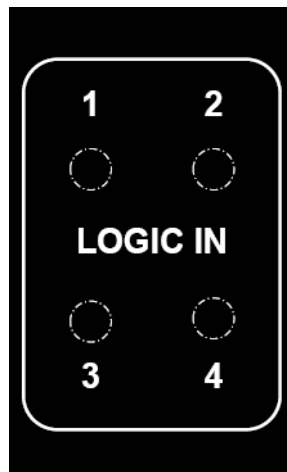

For example, one simple way to detect an AC mains power failure at a site where the system is powered by a battery bank is to use a repurposed wall transformer. You can wire the output of the transformer to drive the relay coil at the appropriate voltage, and use a set of contacts to pull a logic input to ground when power is applied. When the power fails, the input is ungrounded causing the controller to execute a macro.

## Logic Outputs

The 7330 can control eight logical (ON/OFF) devices at the repeater site with its logic outputs.

The logic output driver, U10, is a TPIC6B596N 8-bit shift register with open-drain power MOSFET outputs. It's a 20-pin DIP and is socketed for easy replacement. You can invert the logic of the outputs using the Select Logic Output Inversion command (see page 15-6).

Each logic output looks like a set of relay contacts to ground. Each output can sink 150 mA when ON and withstand 45 V when OFF. Its low ON resistance (5 ohms) allows it to control a wide range of PTT circuit types, from TTL logic to large DC relay coils.

Since the drain connections of the MOSFETs are brought out to the connector without pullup resistors, this configuration is called open drain (similar to open collector circuits using bipolar transistors). An ohmmeter cannot be used to check the logic outputs, since no change will be seen when the outputs are turned ON and OFF. A DC power source and a load of some type will be needed to see the outputs change state. If you need TTL-compatible outputs, connect 3K pullup resistors from the desired outputs to the +5 V power supply of the TTL device being driven.

Logic outputs are very handy for controlling external devices and appliances at the site. Loads include incandescent lamps, LEDs, integrated or discrete logic, and relay coils.

---

**Note:** When using logic outputs to drive large inductive loads (such as large relay coils), connect a diode across the load in the non-conducting direction.

---

The controller will remember the status of each logic output during power outages. When power returns, the controller will turn the outputs ON or OFF to match the conditions before the power loss. A Cold Start sequence will force all outputs OFF.

The states of the logic outputs are shown on the front panel LEDs and can be checked with Booleans and the If/Then/Else command:

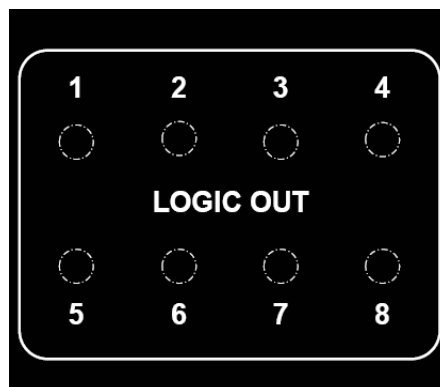

## A-to-D Inputs

The 7330 can monitor three voltages at the repeater site with its 8-bit analog-to-digital (A-to-D or A2D) inputs. Each channel can measure voltages in the range of 0 to 5 volts or 0 to 25 voltages depending on the range selected. With additional user-supplied external hardware, additional ranges can be supported.

Each A-to-D input circuit consists of voltage divider resistors, an over-voltage protection device, and a jumper. The range for each input is selected by the jumper. The over-voltage protection device protects the A-to-D converter from a voltage outside the configured range.

Locate the jumpers on the Board Silkscreen (see page B-18). Installing the jumper selects the 0 to 25 volt range. Removing the jumper selects the 0 to 5 volt range.

Input Number	Jumper Number	Range 0 to 5 Volts	Range 0 to 25 Volts
ADC #1	J13	OUT	IN
ADC #2	J14	OUT	IN
ADC #3	J15	OUT	IN

When changing the range selection jumper for an analog input, a corresponding programming command must be entered for the firmware to properly scale the readings from the analog input. See chapter 16.

Analog inputs are very handy for the monitoring of voltages by the controller. Examples include measuring the voltage of a battery, the strength of a signal into a receiver, or temperature.

---

**Note:** for controller firmware to properly read the input voltage, a range selection command must be entered that matches the jumper position. See chapter 16, A-to-D Converter, for details.

---

# Board Silkscreen

Port connectors, jumpers, test points, and potentiometers:

- Port 1
- Port 2
- Port 3

Logic I/O and A/D connector and jumpers.

- Inputs and Outputs

**Viewing Tip:** in Adobe Reader, use the Marquee Zoom to zoom in on specific areas of the board to view the detail.

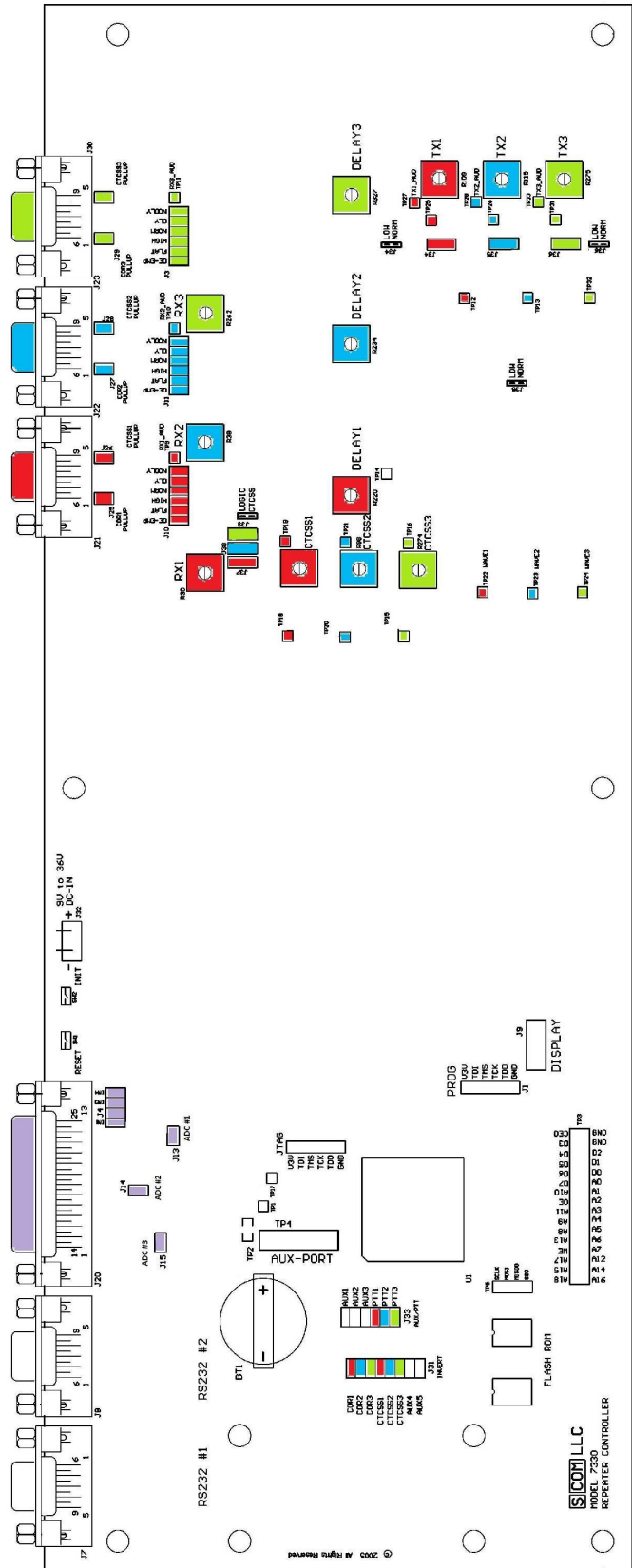

---

## Radio Port Connectors

The 7330 has three 9-pin D-subminiature female connectors for interfacing to the three radios. Use the mating male connectors (supplied). (This pin layout surrounds the RX and TX audio pins with low impedance signals to better isolate them.)

Pin	Name	Type
1	Receiver Audio	Audio Input
2	Receiver COR	Logic Input
3	Receiver CTCSS Decode	Logic Input
4	Transmitter PTT	Logic Output
5	Transmitter Audio	Audio Output
6	Ground for Receiver Audio	Ground
7	Ground for CTCSS Audio	Ground
8	Transmitter CTCSS Audio or CTCSS Logic Output	Analog Output or Logic Output
9	Ground for Transmitter Audio	Ground

## I/O Connector

The 7330 has a 25-pin D-subminiature female connector for interfacing to its eight logic outputs, four logic inputs, and three A/D (analog-to-digital) inputs. Use the mating male connector (supplied).

Pin	Name
1	Logic Output 1
2	Logic Output 2
3	Logic Output 3
4	Logic Output 4
5	Logic Output 5
6	Logic Output 6
7	A/D Input 3
8	A/D Input 2
9	A/D Input 1
10	Logic Input 1
11	Logic Input 2
12	Logic Input 3
13	Logic Input 4
14	Logic Output 7
15	Logic Output 8
16	Ground
17	Ground
18	Ground
19	Ground
20	Ground
21	Ground
22	Ground
23	Ground
24	Ground
25	Ground

## RS-232 Connectors

The 7330 supports two RS-232 ports.

RS232-1 is set up for DTE (Data Terminal Equipment) with no modem support. It uses J7, a 9-pin D-subminiature male connector. A mating connector is supplied.

RS232-1 (DTE)		
Pin	Name	Notes
1	DCD	Not supported
2	RXD	
3	TXD	
4	DTR	Internally connected to DSR
5	GND	
6	DSR	Internally connected to DTR
7	RTS	Not supported
8	CTS	Not supported
9	RI	N/C

RS232-2 is set up for DCE (Data Communications Equipment) with no modem support. It uses J8, a 9-pin D-subminiature female connector. A mating connector is supplied.

RS232-2 (DCE)		
Pin	Name	Notes
1	DCD	N/C
2	RXD	
3	TXD	
4	DTR	Internally connected to DSR
5	GND	
6	DSR	Internally connected to DTR
7	RTS	Internally connected to CTS
8	CTS	Internally connected to RTS
9	RI	N/C

## Potentiometers

The initial adjustments of receiver audio level, transmitter audio level, CTCSS encoder levels and audio delay durations are adjusted with mechanical potentiometers. Message levels can be adjusted in soft pots during message programming. Turn pots clockwise to increase delay or level, counter-clockwise to decrease.

Name	Pot #	Description
RX1	R30	Adjusts level from Receiver 1
RX2	R38	Adjusts level from Receiver 2
RX3	R262	Adjusts level from Receiver 3
TX1	R109	Adjusts level to Transmitter 1
TX2	R115	Adjusts level to Transmitter 2
TX3	R275	Adjusts level to Transmitter 3
DELAY1	R220	Adjusts RX1 audio delay
DELAY2	R234	Adjusts RX2 audio delay
DELAY3	R327	Adjusts RX3 audio delay
CTCSS1	R90	Adjusts output level of CTCSS Encoder 1
CTCSS2	R98	Adjusts output level of CTCSS Encoder 2
CTCSS3	R274	Adjusts output level of CTCSS Encoder 3

**Note:** Message levels can be adjusted in soft pots during message programming. See the Message Level section of Chapter 6.



## Jumpers

Descriptions in **BOLD** in the Jumper columns define factory defaults.

	Name	Description	Jumper IN	Jumper OUT	
J10	DE-EMP	RX1 De-emphasis	Accepts discriminator audio	(Install one or the other only)	
	FLAT	RX1 Flat	<b>Accepts flat audio</b>		
	HIGH	RX1 High Gain	Gain of 6.3	(Install one or the other only)	
	NORM	RX1 Normal Gain	<b>Gain of 2</b>		
	DLY	RX1 Audio Delay	Audio Delay Enabled		
J11	NODLY	RX1 No Delay	<b>Audio Delay Disabled</b>	(Install one or the other only)	
	DE-EMP	RX2 De-emphasis	Accepts discriminator audio	(Install one or the other only)	
	FLAT	RX2 Flat	<b>Accepts flat audio</b>		
	HIGH	RX2 High Gain	Gain of 6.3	(Install one or the other only)	
	NORM	RX2 Normal Gain	<b>Gain of 2</b>		
DLY	RX2 Audio Delay	Audio Delay Enabled			
J3	NODLY	RX2 No Delay	<b>Audio Delay Disabled</b>	(Install one or the other only)	
	DE-EMP	RX3 De-emphasis	Accepts discriminator audio	(Install one or the other only)	
	FLAT	RX3 Flat	<b>Accepts flat audio</b>		
	HIGH	RX3 High Gain	Gain of 6.3	(Install one or the other only)	
	NORM	RX3 Normal Gain	<b>Gain of 2</b>		
DLY	RX3 Audio Delay	Audio Delay Enabled			
J34	NODLY(X)	RX3 No Delay	<b>Audio Delay Disabled</b>	(Install one or the other only)	
	LOW	TX1 Low Drive	Gain of 0.5	(Install one or the other only)	
	NORM	TX1 Normal Drive	<b>Gain of 2</b>		
	J35	LOW	TX1 Low Drive	Gain of 0.5	(Install one or the other only)
		NORM	TX1 Normal Drive	<b>Gain of 2</b>	
J36	LOW	TX1 Low Drive	Gain of 0.5	(Install one or the other only)	
	NORM	TX1 Normal Drive	<b>Gain of 2</b>		
J37	LOGIC	TX1 Pin 8 Logic	Pin 8 fed by Logic Output	(Install one or the other only)	
	CTCSS	TX1 Pin 8 Tone	<b>Pin 8 fed by CTCSS Encoder</b>		
J38	LOGIC	TX2 Pin 8 Logic	Pin 8 fed by Logic Output	(Install one or the other only)	
	CTCSS	TX2 Pin 8 Tone	<b>Pin 8 fed by CTCSS Encoder</b>		
J39	LOGIC	TX3 Pin 8 Logic	Pin 8 fed by Logic Output	(Install one or the other only)	
	CTCSS	TX3 Pin 8 Tone	<b>Pin 8 fed by CTCSS Encoder</b>		
J25	COR1 PULLUP	RX1 COR Pullup	<b>Pullup Enabled</b>	Pullup Disabled	
J27	COR2 PULLUP	RX2 COR Pullup	<b>Pullup Enabled</b>	Pullup Disabled	
J29	COR3 PULLUP	RX3 COR Pullup	<b>Pullup Enabled</b>	Pullup Disabled	
J26	CTCSS1 PULLUP	RX1 CTCSS Pullup	<b>Pullup Enabled</b>	Pullup Disabled	
J28	CTCSS2 PULLUP	RX2 CTCSS Pullup	<b>Pullup Enabled</b>	Pullup Disabled	
J30	CTCSS3 PULLUP	RX3 CTCSS Pullup	<b>Pullup Enabled</b>	Pullup Disabled	

	Name	Description	Jumper IN	Jumper OUT
J4	IN1	Logic Input 1 Pullup	<b>Pullup Enabled</b>	Pullup Disabled
	IN2	Logic Input 2 Pullup	<b>Pullup Enabled</b>	Pullup Disabled
	IN3	Logic Input 3 Pullup	<b>Pullup Enabled</b>	Pullup Disabled
	IN4	Logic Input 4 Pullup	<b>Pullup Enabled</b>	Pullup Disabled
J31	COR1	Inverts RX 1 COR	High Active	<b>Low Active</b>
	COR2	Inverts RX 2 COR	High Active	<b>Low Active</b>
	COR3	Inverts RX 3 COR	High Active	<b>Low Active</b>
	CTCSS1	Inverts RX 1 CTCSS	High Active	<b>Low Active</b>
	CTCSS2	Inverts RX 2 CTCSS	High Active	<b>Low Active</b>
	CTCSS3	Inverts RX 3 CTCSS	High Active	<b>Low Active</b>
J33	PTT1	Inverts TX 1 PTT	High Active	<b>Low Active</b>
	PTT2	Inverts TX 2 PTT	High Active	<b>Low Active</b>
	PTT3	Inverts TX 3 PTT	High Active	<b>Low Active</b>
J13	J13	ADC Input 1 Range	<b>0 – 25 V</b>	0 – 5 V
J14	J14	ADC Input 2 Range	<b>0 – 25 V</b>	0 – 5 V
J15	J15	ADC Input 3 Range	<b>0 – 25 V</b>	0 – 5 V
J33	AUX1	Reserved		
	AUX2	Reserved		
	AUX3	Reserved		
J31	AUX4	Reserved		
	AUX5	Reserved		
J12	J12	Reserved		
J16	J16	Battery Current	<b>Normal</b>	Factory Only

Note: J16 is a jumper that is present on board serial numbers 101 and newer. This jumper is used at the factory for measuring battery current. It should not be used in the field.

## Test Points

Name	Description	Normal Reading
TP1	Lithium battery (+) terminal	+3 VDC
TP17	Watchdog strobe	
TP29	Power supply reference	+1.2 VDC
TP14	Bias Supply for audio section	+2.5 VDC
TP9	RX1 audio	1 V p-p audio on +2.5 VDC bias
TP10	RX2 audio	1 V p-p audio on +2.5 VDC bias
TP11	RX3 audio	1 V p-p audio on +2.5 VDC bias
TP22	TX1 tone & digital audio (before digital pot)	1 V p-p audio on +2.5 VDC bias
TP23	TX2 tone & digital audio (before digital pot)	1 V p-p audio on +2.5 VDC bias
TP24	TX3 tone & digital audio (before digital pot)	1 V p-p audio on +2.5 VDC bias
TP12	TX1 tone & digital audio (after digital pot)	Depends on pot setting, +2.5 VDC bias
TP13	TX2 tone & digital audio (after digital pot)	Depends on pot setting, +2.5 VDC bias
TP32	TX3 tone & digital audio (after digital pot)	Depends on pot setting, +2.5 VDC bias
TP18	TX1 CTCSS tone (before pot)	1 V p-p audio on +2.5 VDC bias
TP20	TX2 CTCSS tone (before pot)	1 V p-p audio on +2.5 VDC bias
TP15	TX3 CTCSS tone (before pot)	1 V p-p audio on +2.5 VDC bias
TP19	TX1 CTCSS tone (at output)	Depends on pot setting, 0 V bias
TP21	TX2 CTCSS tone (at output)	Depends on pot setting, 0 V bias
TP16	TX3 CTCSS tone (at output)	Depends on pot setting, 0 V bias
TP25	TX1 audio (before pot)	1 V p-p audio on +2.5 VDC bias
TP26	TX2 audio (before pot)	1 V p-p audio on +2.5 VDC bias
TP31	TX3 audio (before pot)	1 V p-p audio on +2.5 VDC bias
TP27	TX1 audio (at output)	Depends on pot setting, 0 V bias
TP28	TX2 audio (at output)	Depends on pot setting, 0 V bias
TP33	TX3 audio (at output)	Depends on pot setting, 0 V bias

## Testing the Transmitter Interface

Apply power to the controller and the repeater while monitoring the transmitter output with an extra receiver. When power is applied, the transmitter should key and send the reset CW message. The blue PTT indicator for the correct port should light on the 7330's front panel.

If the transmitter does not key at all:

- Be sure both the controller and the repeater are powered up. The green ON indicator on the 7330's front panel should be lit.
- Check the wiring, particularly the connection between the controller's PTT output and the transmitter's PTT input.

If the transmitter is acting *upside down* (unkeying during the message but keying afterwards), install or remove the PTT inversion jumper as needed.

If the transmitter is keying properly but no CW message is heard, check the wiring from the correct 7330 transmitter audio output to the transmitter's audio input.

The CW level can be adjusted via command. See the *Messages* chapter on page 6-1.

If the CW message is too loud with the level commanded nearly all the way down, you may be driving the microphone input of the transmitter instead of a later stage. If you cannot drive a later stage, you may need to attenuate the audio output. See the *Transmitter Audio* section above regarding the TX Drive jumper.

## Testing the Receiver Interface

Generate an RF signal on the receiver's input frequency. The blue COR indicator for the correct port should light on the 7330's front panel. If you have installed a CTCSS decoder, generate the correct CTCSS tone. The blue CTCSS indicator should light.

The controller should key the repeater transmitter. When the signal disappears, you should hear a courtesy beep after a short pause. The transmitter should stay keyed for a few more seconds, then unkey.

If this does not happen:

- With the COR connected between the receiver and controller, check the voltage on the COR line to see if it swings above and below the 2 V threshold.
- If a CTCSS decoder is used, with the decode line connected between the decoder and controller, check the voltage on the decode line to see if it swings above and below the 2 V threshold.

If the COR or the CTCSS decoder (or both) is acting *upside down* (unkeying when a signal exists but keying afterwards), install or remove the COR or CTCSS inversion jumper(s) as needed.

The default condition of the controller causes a 0.5-second delay between the loss of carrier and the courtesy beep. The transmitter will stay keyed for an additional 3.0 second dropout delay. These characteristics may all be changed later, so don't be concerned if this isn't the way you wish the repeater to act.

- Generate a modulated RF signal on the repeater's input frequency (a service monitor is quite helpful).
- Check the audio level for 1 V p-p.
- Check the transmitter for proper deviation, and
- Adjust the Transmitter Audio Output pot as necessary.

## Testing The DTMF Decoder

Your controller uses an 8870-type DTMF decoder IC on each receiver input. This crystal-controlled device decodes all 16 DTMF digits. It has an extremely wide dynamic range (30 dB), and can detect digits that have as much as -6 dB to +6 dB of twist.

(*Twist* refers to the difference in amplitude between the two individual tones that are summed to make up a DTMF digit. The more twist a system gives to DTMF digits, the more difficult it is to detect the digits. In repeater systems, twist can be caused by a number of things, including user's transmitter.

(The audio fed into the transmitter is pre-emphasized before it is applied to the limiter circuit. Pre-emphasis causes high frequency tones to have more amplitude than low frequency tones, so the high frequency tone of a DTMF digit can be severely clipped while the low frequency tone is not. The result is twist, and the solution is to keep the DTMF pad audio at a reasonably low level. Twist can also be introduced by the repeater receiver if it has poor audio response, or if a poor impedance match exists between the receiver and the controller.)

### Local Control

You can program the controller with a local DTMF keypad, if desired.

- Connect the audio from the keypad to a receiver audio input.
- Connect a switch between the correct COR Input and ground.
- Whenever the switch is ON (closed), the controller will accept commands from the keyboard. Return the switch to the OFF (open) position when finished programming.

### Performing the Tests

Generate an RF signal on the repeater's input frequency.

- While listening to the repeater output on an extra receiver, send some DTMF digits to the repeater.
- You should hear a short burst of DTMF, followed by silence, as the controller detects the digit and then mutes it.
- If the digits are passed through to the transmitter with no muting taking place, the DTMF decoder is not recognizing the digits.

There are several areas to check:

- Check the receive audio level for 1 V p-p as described previously.

- Check the operation of the COR Input. If the COR input isn't active, the DTMF decoder will not be monitoring the receiver audio.
- Check to see if a command was entered to disable the DTMF decoder.

## Falsing

Some users' voices can contain frequency components that appear as DTMF digits to the decoder. If such a digit is detected, *falsing* is said to occur. If the DTMF muting feature is enabled, the result of falsing is the loss of repeat audio for a syllable or two. In addition, an accidental digit is stored into the controller's command buffer. This last item is not usually a problem, however, because the digit will be discarded after a few seconds when the controller discovers that the digit was no part of a valid command. In any case, falsing is annoying and can usually be cured to an acceptable extent.

Several solutions to falsing are available:

- **Reduce DTMF mute time.** Use the *Select DTMF Decoder Mute Hang Time for First Character* command on page 7-22 to reduce the mute time for the first DTMF digit. If you do this, a portion of the first valid DTMF digit may be heard.. For a false digit, this will minimize the amount of lost audio. Adjust the time for the best compromise.
- **Turn DTMF muting completely off.** Use the *Enable/Disable DTMF Decoder Mute* command on page 7-20 to disable DTMF muting. If you do this, all DTMF digits will be repeated. This is a simple fix, but it may not be acceptable for repeaters that need security for DTMF commands.
- **Don't overdrive the DTMF decoder.** The higher the audio level to the decoder, the more likely it is to false. Check the audio level at the output of the receiver's op amp. If over the recommended 1 V p-p, turn the audio level down. Overdriving the decoder will not help it decode any better.
- **Increase the DTMF decoder's detect time.** Each decoder's tone detect time is controlled by a 300K resistor on pin 16 of the decoder IC. This provides a rather fast 40 mS detect time (a telephone industry standard). Increasing the resistor will require a longer detect time, thus reducing the possibility of falsing. The disadvantage of slowing the detection time is that some DTMF autodialers generate digits at a rapid rate; a long detection time could result in missed digits. If autodialers are not a problem, increasing the detection time will make a noticeable improvement in falsing. Field experience has shown that changing the resistor to 500K will solve minor cases, and changing it to 1M will solve nearly all cases. The slower response to DTMF digits has not been a problem for users, since the increase in time is small by human operator standards.
- **Use the DTMF Decoder Disconnect Timer.** (See page 7-16.) This reduces falsing because the DTMF decoder is active only for a limited time at the beginning of a user's transmission. If no DTMF characters are detected by the time the timer expires, the controller will ignore all DTMF for the remainder of the transmission. If a user hasn't entered the first DTMF character before the timer expires, he will have to unkey and make a new transmission. The disconnect timer is restarted each time a valid DTMF character is detected. There are two commands

associated with this feature. One enables and disables it and the other sets the duration of the timer.

## Battery Replacement

### Introduction

All S-COM controllers use a non-rechargeable 3-volt lithium coin cell to maintain memory data and keep track of the time and date during power outages. The cell is visible in some models and sealed inside a memory module in others. In the 7330, the cell is located on the main board and socketed for easy replacement.

Before the 7330, cell current was negligible whether the controller was powered or not. The lifetime of the cell was about the same as its shelf life (10 years).

In the 7330, cell current is negligible when the controller is powered and about 4 uA when unpowered. The current is used by a large RAM, a clock/calendar IC, and a TCXO (Temperature Controlled Crystal Oscillator) timebase for the clock/calendar. The cell will last for several years with power off. However, if the 7330 is stored for a long period of time, it is a good idea to replace the coin cell before putting the controller back into service.

Note that a lithium coin cell maintains a fairly constant voltage over its lifetime. Measuring its voltage will not provide an accurate reading of remaining capacity.

### Replacement Procedure

Note: replacing the battery will require you to initialize the controller and reload your programming.

You will need one BR2032 or CR2032 lithium coin cell and a flat-blade screwdriver, preferably one with a plastic blade.

1. Locate shunt J16 and pull it out. This disconnects the cell from its load.
2. The coin cell holder has a high retention force to prevent the cell from being dislodged by vibration. The cell is retained by several plastic tabs around the top of the holder. Insert the blade under the coin cell and twist to pop the cell from its holder.
3. There are gold contacts at opposite ends of the holder: the raised contacts make contact with the top of the coin cell. Hold the new coin cell with the markings up. Insert it into the holder at an angle, being certain the top of the cell goes under the raised contacts. Press the cell down until it snaps into place.
4. Replace jumper J16.
5. Cold Start the controller following the instructions on page 2-26.
6. Reload your programming.

**Notes:**



---

## *Appendix E*

# Specifications

---

### **Introduction**

This section lists technical specifications of the 7330.

## Receiver and Transmitter Ports

(All three receiver and transmitter interfaces have identical specifications.)

Receiver Audio Input Impedance: 25K ohms or greater; varies with input level pot setting

Receiver De-emphasis Corner Frequency: Approximately 200 Hz

Receiver Audio Delay: Adjustable via pot from 30 to greater than 250 milliseconds

Receiver COR and CTCSS Input Thresholds: Approximately 2.1 V

Receiver COR and CTCSS Pullups: 4.7K ohms to +5V, enabled or disabled via jumpers

Receiver COR and CTCSS Input Logic: Jumper-selectable for active low or active high

Transmitter Audio Output Impedance: 600 ohms

Transmitter Audio Output Level: 2 V p-p (10K ohms), 1 V p-p (600 ohms)

Transmitter PTT Driver: Open-drain power MOSFET (TPIC6B596N IC)

Transmitter PTT Current: Sinks 150 mA in the ON state (5 ohms to ground)

Transmitter PTT Voltage: Withstands 45 V in the OFF state

Overall measured frequency response: Shown with and without the audio delay feature in the tables below.

Response With No Audio Delay								
<b>TX Load</b>	<b>-3 dB</b>	<b>-2 dB</b>	<b>-1 dB</b>	<b>0 dB</b>	<b>0 dB</b>	<b>-1 dB</b>	<b>-2 dB</b>	<b>-3 dB</b>
10K ohms	11 Hz	13 Hz	17 Hz	50 Hz	3 kHz	8 kHz	12 kHz	16 kHz
600 ohms	18 Hz	23 Hz	35 Hz	100 Hz	3 kHz	8 kHz	12 kHz	16 kHz

Response With Audio Delay								
<b>TX Load</b>	<b>-3 dB</b>	<b>-2 dB</b>	<b>-1 dB</b>	<b>0 dB</b>	<b>0 dB</b>	<b>-1 dB</b>	<b>-2 dB</b>	<b>-3 dB</b>
10K ohms	18 Hz	22 Hz	30 Hz	80 Hz	2 kHz	4.5 kHz	5.6 kHz	6.2 kHz
600 ohms	25 Hz	32 Hz	50 Hz	160 Hz	2 kHz	4.5 kHz	5.6 kHz	6.2 kHz

## Tone Generators

(All three Tone Generators have identical specifications.)

Distortion: Shown at various tone frequencies in the table below

Multitone Capability: Encodes single and dual tones

Filter: Five-pole Butterworth lowpass filter with a cutoff frequency of 4000 Hz

Tone accuracy: Better than 0.12% for tones up to 1700 Hz

Distortion vs. Frequency					
Freq (Hz)	% THD	dB THD	dB 3rd Har.	dB 5th Har.	dB 7th Har.
100	1.70	-35	-35	-47	-50
300	1.65	-36	-35	-47	-50
1000	1.60	-36	-36	-56	-71
1500	0.90	-41	-41	-71	---
2000	0.26	-52	-52	---	---
3000	0.05	-66	-68	---	---

## CTCSS Encoders

(All three CTCSS Encoders have identical specifications.)

Measured distortion: Shown at various CTCSS tone frequencies in the table below

Phase Reversal: Selectable 0, 120, or 180 degrees

Filter: Five-pole Butterworth lowpass filter with a cutoff frequency of 250 Hz

Tone accuracy: Better than 0.02%

Output Level: Adjustable 0 to 2 V p-p (700 mV rms) into 20K load

Distortion vs. Frequency					
Freq (Hz)	% THD	dB THD	dB 3rd Har.	dB 5th Har.	dB 7th Har.
67.0	1.7	-35	-35 (201 Hz)	-57 (335 Hz)	-75 (469 Hz)
85.4	1.3	-38	-38 (256 Hz)	-67 (427 Hz)	-85 (598 Hz)
100.0	0.76	-42	-42 (300 Hz)	-73 (500 Hz)	---
123.0	0.28	-50	-50 (369 Hz)	-83 (615 Hz)	---
151.4	0.10	-60	-60 (454 Hz)	---	---
173.8	0.05	-67	-67 (521 Hz)	---	---
203.5	0.03	-70	-70 (610 Hz)	---	---

## Logic Inputs

Number of Logic Inputs: 4

Input Circuit: NPN-buffered

Input Threshold: Approximately 2.1 V

Pullups: 4.7K ohms to +5V, enabled or disabled via jumpers.

## Logic Outputs

Number of Logic outputs: 8

Output Circuit: Open-drain power MOSFET (TPIC6B596N IC)

Current: Sinks 150 mA in the ON state (5 ohms to ground)

Voltage: Withstands 45 V in the OFF state

## A/D Inputs

Number of A/D Inputs: 3

Input Range: 0 – 5 V or 0 – 25 V

Input Protection: Overvoltage

## Clock/Calendar

Oscillator: 32.768 kHz temperature compensated crystal oscillator (TCXO)

Timekeeping Accuracy:  $\pm 1$  min/year from 0°C to 40°C

## Memory

Flash: 128 Mb (16 MB)

RAM: 512 KB CMOS SRAM with battery backup

## Battery

Type: BR2032 lithium cell

## DC Power

Input Voltage Range: +9 to +36 volts DC

Power Consumption: Approximately 1.5 watts

Input Protection: Reverse polarity

## Cabinet

Height: single rack height (1U)

Front Panel Indicators: 28 3-mm LEDs as shown in the table below

Legend	Indication	Color
ON	Power ON	Green
PORT 1 COR	Receiver 1 COR Input	Blue
PORT 1 CTCSS	Receiver 1 CTCSS Input	Blue
PORT 1 DTMF	Receiver 1 DTMF Decoder	Blue
PORT 1 PTT	Transmitter 1 Push-to-Talk	Blue
PORT 1 ENC	Transmitter 1 CTCSS Encoder	Blue
PORT 2 COR	Receiver 2 COR Input	Blue
PORT 2 CTCSS	Receiver 2 CTCSS Input	Blue
PORT 2 DTMF	Receiver 2 DTMF Decoder	Blue
PORT 2 PTT	Transmitter 2 Push-to-Talk	Blue
PORT 2 ENC	Transmitter 2 CTCSS Encoder	Blue
PORT 3 COR	Receiver 3 COR Input	Blue
PORT 3 CTCSS	Receiver 3 CTCSS Input	Blue
PORT 3 DTMF	Receiver 3 DTMF Decoder	Blue
PORT 3 PTT	Transmitter 3 Push-to-Talk	Blue
PORT 3 ENC	Transmitter 3 CTCSS Encoder	Blue
LOGIC IN 1	Logic Input 1	Blue
LOGIC IN 2	Logic Input 2	Blue
LOGIC IN 3	Logic Input 3	Blue
LOGIC IN 4	Logic Input 4	Blue
LOGIC OUT 1	Logic Output 1	Blue
LOGIC OUT 2	Logic Output 2	Blue
LOGIC OUT 3	Logic Output 3	Blue
LOGIC OUT 4	Logic Output 4	Blue
LOGIC OUT 5	Logic Output 5	Blue
LOGIC OUT 6	Logic Output 6	Blue
LOGIC OUT 7	Logic Output 7	Blue
LOGIC OUT 8	Logic Output 8	Blue

Rear Panel Items: Shown in table below

<b>Legend</b>	<b>Use</b>	<b>Description</b>
PORT 3	Port 3 Connector	9-Pin D-Sub Female
PORT 2	Port 2 Connector	9-Pin D-Sub Female
PORT 1	Port 1 Connector	9-Pin D-Sub Female
DC 9V-36V	DC Power Input Connector	Detachable Terminal Block
INIT	Initialize Pushbutton	
RESET	Reset Pushbutton	
I/O	Logic I/O and A/D Input Connector	25-Pin D-Sub Female
RS232-2	RS232 Serial Port 2 Connector	9-Pin D-Sub Female
RS232-1	RS232 Serial Port 1 Connector	9-Pin D-Sub Male

## Hardware

Mounting Screws: Main Board and Display Board, 6-32x1/4 Philips pan head, stainless steel; Cabinet, 4-40x1/4 Philips pan head, stainless steel